

DATA SHEET

SKY13408-465LF: 1.0 – 6.0 GHz SP3T Switch, 50 Ω Terminated

Applications

- WiMAX 802.16
- Dual-band WLANs (802.11 a/b/g/n)
- LTE/4G systems
- WLAN 802.11a/c
- 5 GHz video distribution

Features

- 50 Ω matched RF ports in all states from 4.5 to 6.0 GHz
- Low insertion loss: 0.7 dB @ 2.5 GHz and 1.1 dB @ 5.85 GHz
- High isolation: 30 dB @ 2.5 GHz and 24.5 dB @ 5.85 GHz
- IP1dB: +34 dBm
- Small, QFN (12-pin, 2 x 2 mm) package (MSL1, 260 °C per JEDEC J-STD-020)



Skyworks Green™ products are compliant with all applicable legislation and are halogen-free. For additional information, refer to *Skyworks Definition of Green™*, document number SQ04-0074.

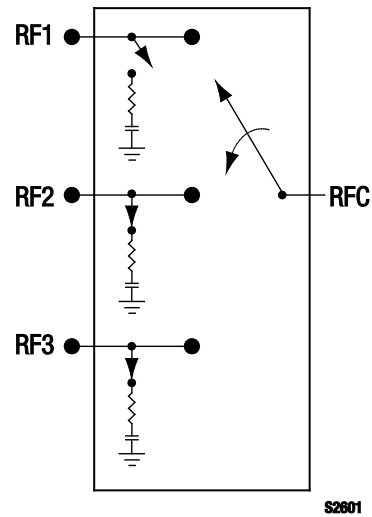

Figure 1. SKY13408-465LF Block Diagram

Description

The SKY13408-465LF is a GaAs pHEMT Single-Pole, Triple-Throw (SP3T) high power switch with 50 Ω terminated outputs. The high linearity performance and low insertion loss achieved by the SKY13408-465LF make it an ideal choice for 802.11a/c, WiMAX, and higher power WLAN applications such as access points.

The switch is manufactured in a compact, 2 x 2 mm, 12-pin Quad Flat No-Lead (QFN) package.

A functional block diagram is shown in Figure 1. The pin configuration and package are shown in Figure 2. Signal pin assignments and functional pin descriptions are provided in Table 1.

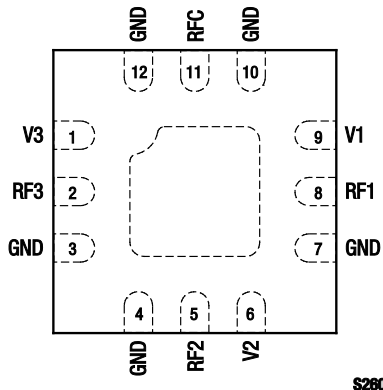

Figure 2. SKY13408-465LF Pinout – 12-Pin QFN (Top View)

Table 1. SKY13408-465LF Signal Descriptions

Pin #	Name	Description	Pin #	Name	Description
1	V3	DC control voltage. See Table 4.	7	GND	Ground
2	RF3	RF port 3. DC blocking capacitor required.	8	RF1	RF port 1. DC blocking capacitor required.
3	GND	Ground	9	V1	DC control voltage. See Table 4.
4	GND	Ground	10	GND	Ground
5	RF2	RF port 2. DC blocking capacitor required.	11	RFC	RF common input. DC blocking capacitor required.
6	V2	DC control voltage. See Table 4.	12	GND	Ground

Table 2. SKY13408-465LF Absolute Maximum Ratings

Parameter	Symbol	Minimum	Typical	Maximum	Units
Control voltage	V _{CTL}			6	V
Input power	P _{IN}			+40	dBm
Storage temperature	T _{STG}	-40		+125	°C
Operating temperature	T _{OP}	-40		+85	°C

Note: Exposure to maximum rating conditions for extended periods may reduce device reliability. There is no damage to device with only one parameter set at the limit and all other parameters set at or below their nominal value. Exceeding any of the limits listed here may result in permanent damage to the device.

CAUTION: Although this device is designed to be as robust as possible, Electrostatic Discharge (ESD) can damage this device. This device must be protected at all times from ESD. Static charges may easily produce potentials of several kilovolts on the human body or equipment, which can discharge without detection. Industry-standard ESD precautions should be used at all times.

Functional Description

Switching is controlled by three control voltage inputs, V1, V2, and V3 (pins 9, 6, and 1, respectively). Depending on the logic voltage level applied to the control pins, the RFC pin is connected to one of the three switched RF outputs (RF1, RF2, or RF3) using a low insertion loss path, while the paths between the RFC pin and the other RF pins are in a high isolation state.

DC blocking capacitors are required on all RF ports of the switch. The value of the capacitors determines the low frequency operation. The isolated RF output ports are internally terminated to 50 Ω. The return loss in the isolation state is limited by on-chip capacitors.

Electrical and Mechanical Specifications

The absolute maximum ratings of the SKY13408-465LF are provided in Table 2. Electrical specifications are provided in Table 3.

Typical performance characteristics of the SKY13408-465LF are illustrated in Figures 3 through 6.

The state of the SKY13408-465LF is determined by the logic provided in Table 4.

Table 3. SKY13408-465LF Electrical Specifications (Note 1)**($V_{CTL} = 0\text{ V}$ and $+3.0\text{ V}$, $T_{OP} = +25\text{ }^{\circ}\text{C}$, $P_{IN} = 0\text{ dBm}$, Characteristic Impedance [Z_0] = $50\text{ }\Omega$, $C_{BLK} = 22\text{ pF}$, Unless Otherwise Noted)**

Parameter	Symbol	Test Condition	Min	Typical	Max	Units
RF Specifications						
Insertion loss	IL	RFC to RF1, RF2 or RF3:				
		1.0 to 4.5 GHz		0.8	1.0	dB
		4.5 to 5.5 GHz		1.0	1.2	dB
		5.5 to 6.0 GHz		1.1	1.3	dB
Isolation	Iso	RFC to RF1, RF2 or RF3:				
		1.0 to 4.5 GHz	25	28		dB
		4.5 to 5.5 GHz	24	26		dB
		5.5 to 6.0 GHz	22	24		dB
Input return loss ("on" state)	IS11I	RFC or RF1 or RF2 or RF3:				
		1.0 to 4.5 GHz		25		dB
		4.5 to 5.5 GHz		25		dB
		5.5 to 6.0 GHz		11		dB
Output return loss ("off" state)	IS22I	Isolated output RF1, RF2, or RF3, 4.5 to 6.0 GHz		18		dB
1 dB Input Compression Point	IP1 dB	$V_{CTL} = 3.0\text{ V}$, 2.3 to 6.0 GHz		+34		dBm
3 rd Order Input Intercept Point	IIP3	$P_{IN} = +25\text{ dBm/}$ tone, $\Delta F = 1\text{ MHz}$, $V_{CTL} = 3.0\text{ V}$, 2.3 to 6.0 GHz		54		dB
2 nd harmonic	2fo	$P_{IN} = +25\text{ dBm}$, $V_{CTL} = 3.0\text{ V}$, 4.5 to 6.0 GHz		+80		dBc
3 rd harmonic	3fo	$P_{IN} = +25\text{ dBm}$, $V_{CTL} = 3.0\text{ V}$, 4.5 to 6.0 GHz		+75		dBc
Switching speed		50% V_{CTL} to 90/10% RF		150		ns
		90/10% RF or 10/90% RF		70		ns
DC Specifications						
Control voltage	V_{CTL}		2.5	3.0	5.0	V
Control current	I_{CC}			25		μA

Note 1: Performance is guaranteed only under the conditions listed in this Table.

Typical Performance Characteristics

($V_{CTL} = 0\text{ V}$ and $+3.0\text{ V}$, $T_{OP} = +25\text{ }^{\circ}\text{C}$, $P_{IN} = 0\text{ dBm}$, Characteristic Impedance [Z_0] = $50\text{ }\Omega$, $C_{BLK} = 22\text{ pF}$, Unless Otherwise Noted)

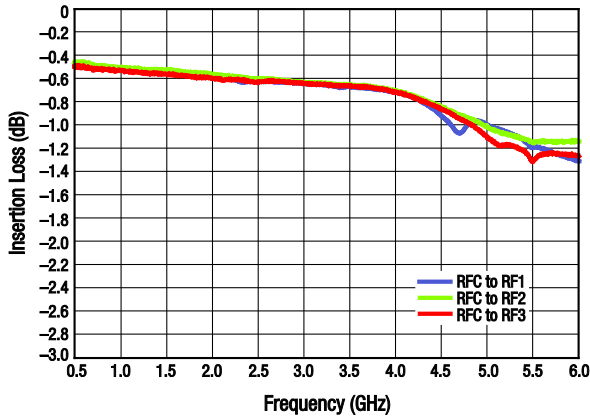

Figure 3. Typical Insertion Loss vs Frequency

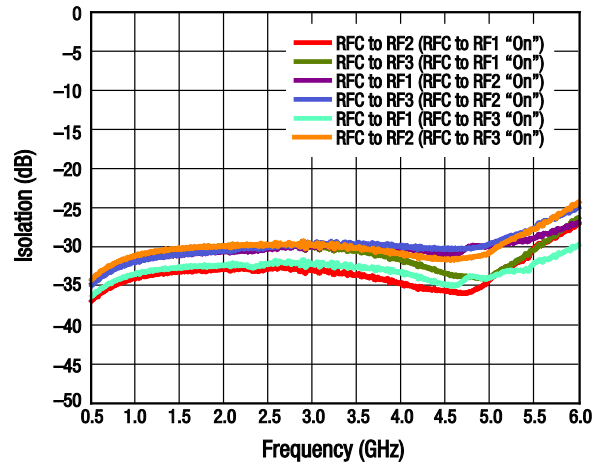

Figure 4. Typical Isolation vs Frequency

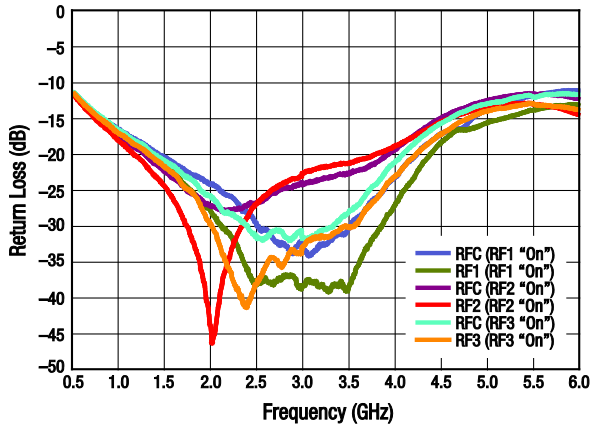

Figure 5. Return Loss vs Frequency (Insertion Loss State)

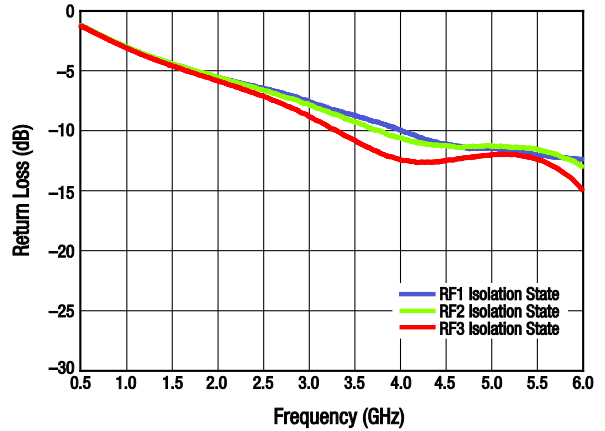

Figure 6. Return Loss vs Frequency (Isolation State)

Table 4. SKY13408-465LF Truth Table

V1 (Pin 9)	V2 (Pin 6)	V3 (Pin 1)	Insertion Loss State
1	0	0	RFC to RF1
0	1	0	RFC to RF2
0	0	1	RFC to RF3

Note: "1" = +2.5 V to +5.0 V. "0" = 0 V to +0.2 V. Any state other than described in this Table places the switch into an undefined state. An undefined state will not damage the device.

Evaluation Board Description

The SKY13408-465LF Evaluation Board is used to test the performance of the SKY13408-465LF SPDT Switch. An Evaluation Board schematic diagram is provided in Figure 7. An assembly drawing for the Evaluation Board is shown in Figure 8.

Package Dimensions

The PCB layout footprint for the SKY13408-465LF is provided in Figure 9. Typical case markings are shown in Figure 10. Package dimensions for the 12-pin QFN are shown in Figure 11, and tape and reel dimensions are provided in Figure 12.

Package and Handling Information

Instructions on the shipping container label regarding exposure to moisture after the container seal is broken must be followed. Otherwise, problems related to moisture absorption may occur when the part is subjected to high temperature during solder assembly.

The SKY13408-465LF is rated to Moisture Sensitivity Level 1 (MSL1) at 260 °C. It can be used for lead or lead-free soldering. For additional information, refer to the Skyworks Application Note, *Solder Reflow Information*, document number 200164.

Care must be taken when attaching this product, whether it is done manually or in a production solder reflow environment. Production quantities of this product are shipped in a standard tape and reel format.

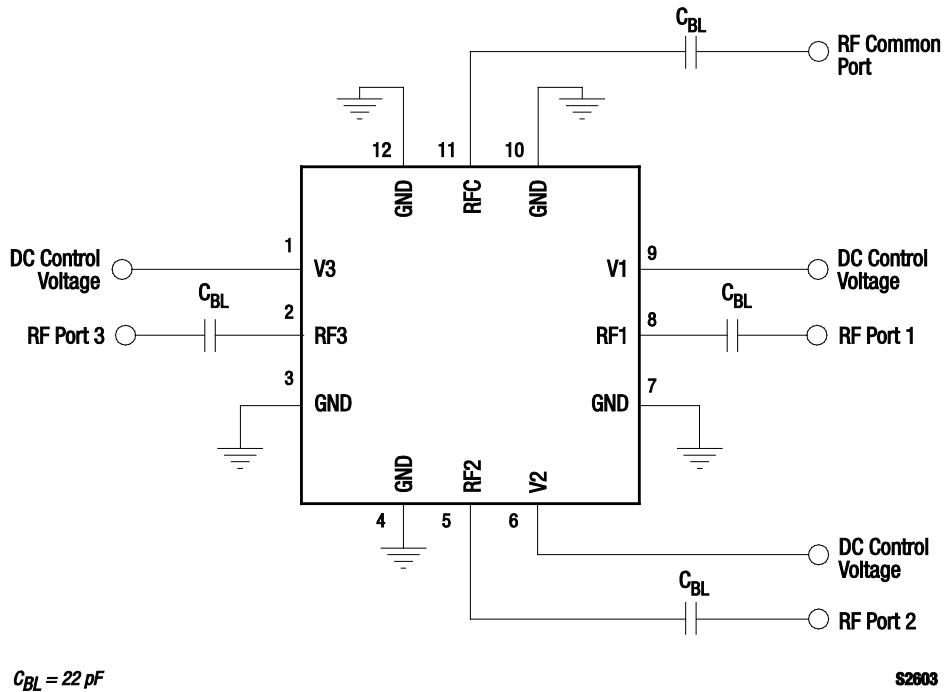

Figure 7. SKY13408-465LF Evaluation Board Schematic

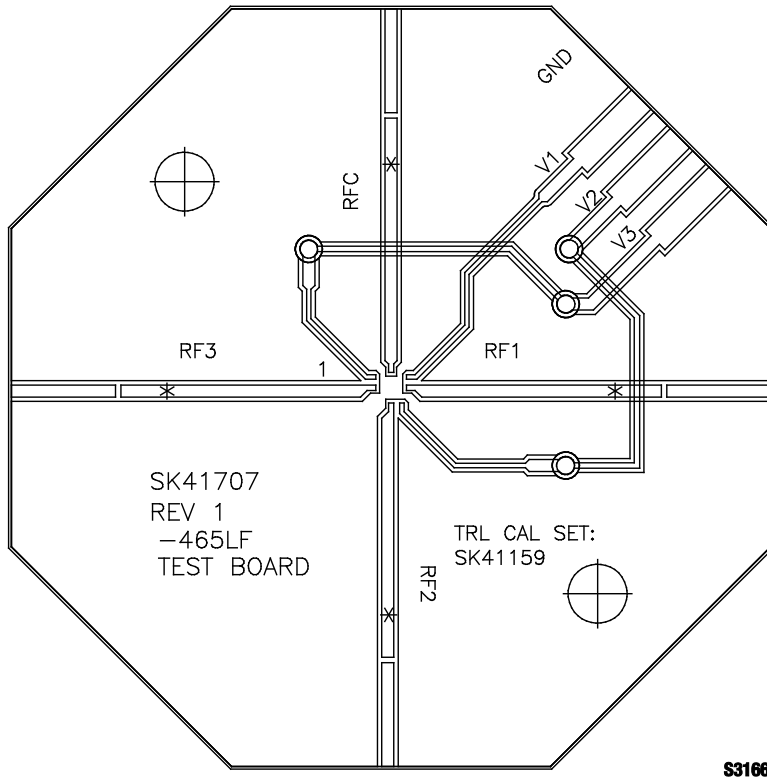

Figure 8. SKY13408-465LF Evaluation Board Assembly Diagram

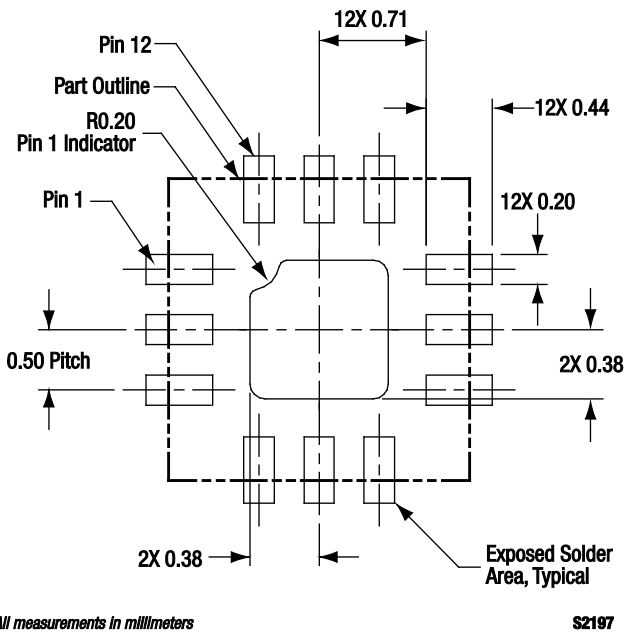

Figure 9. SKY13408-465LF PCB Layout Footprint (Top View)

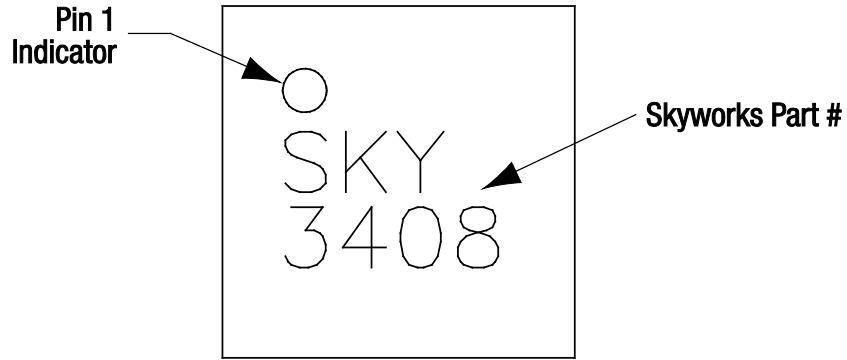
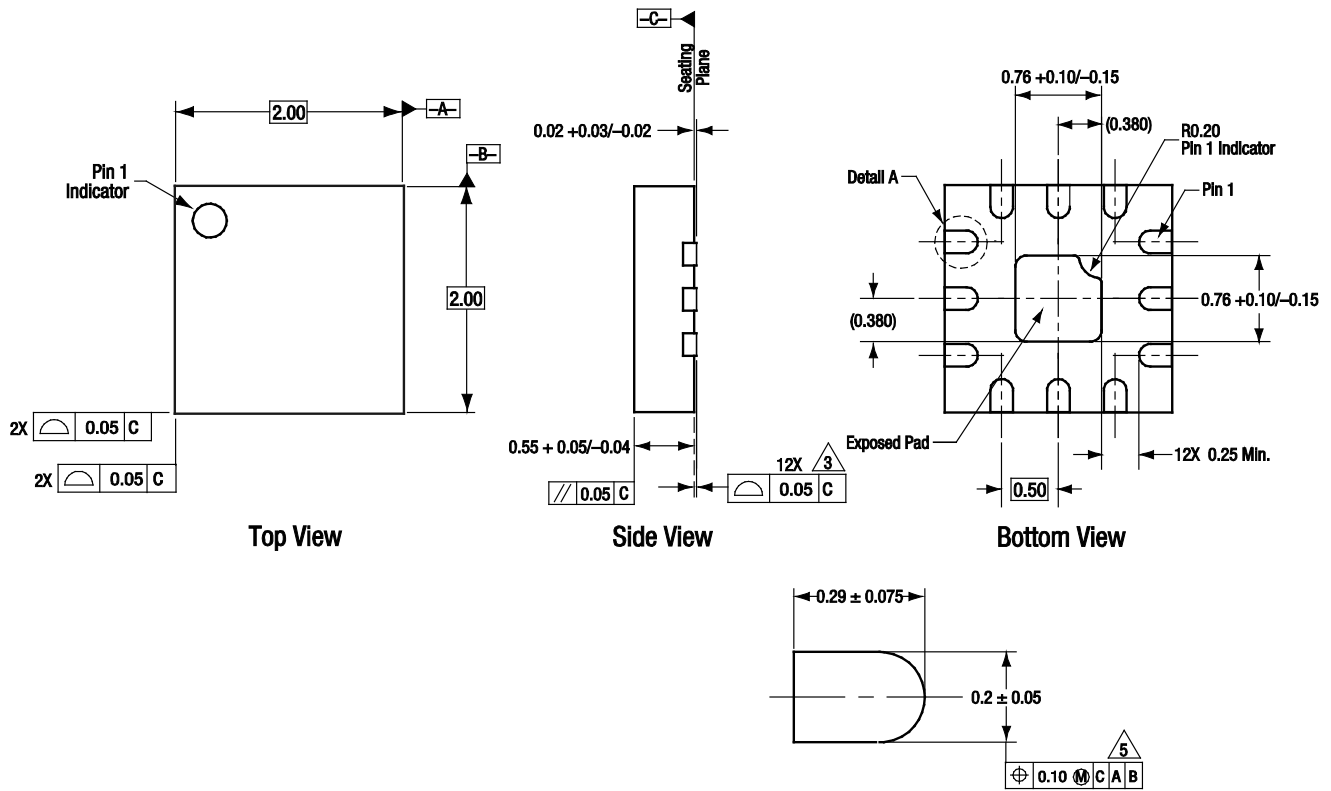

Figure 10. Typical Part Markings (Top View)



All measurements are in millimeters.
 Dimensioning and tolerancing according to ASME Y14.5M-1994.
 Coplanarity applies to the terminals and all other bottom surface metalization.
 Dimension applies to metalized terminal. If the terminal has a radius on its end,
 the width dimension should not be measured in that radius area.

Detail A
 Scale: 100X
 12 Places

S2198

Figure 11. SKY13408-465LF 12-Pin QFN Package Dimensions

Ordering Information

Model Name	Manufacturing Part Number	Evaluation Board Part Number
SKY13408-465LF SP3T Switch	SKY13408-465LF	SKY13408-465LF-EVB

Copyright © 2011, 2012 Skyworks Solutions, Inc. All Rights Reserved.

Information in this document is provided in connection with Skyworks Solutions, Inc. ("Skyworks") products or services. These materials, including the information contained herein, are provided by Skyworks as a service to its customers and may be used for informational purposes only by the customer. Skyworks assumes no responsibility for errors or omissions in these materials or the information contained herein. Skyworks may change its documentation, products, services, specifications or product descriptions at any time, without notice. Skyworks makes no commitment to update the materials or information and shall have no responsibility whatsoever for conflicts, incompatibilities, or other difficulties arising from any future changes.

No license, whether express, implied, by estoppel or otherwise, is granted to any intellectual property rights by this document. Skyworks assumes no liability for any materials, products or information provided hereunder, including the sale, distribution, reproduction or use of Skyworks products, information or materials, except as may be provided in Skyworks Terms and Conditions of Sale.

THE MATERIALS, PRODUCTS AND INFORMATION ARE PROVIDED "AS IS" WITHOUT WARRANTY OF ANY KIND, WHETHER EXPRESS, IMPLIED, STATUTORY, OR OTHERWISE, INCLUDING FITNESS FOR A PARTICULAR PURPOSE OR USE, MERCHANTABILITY, PERFORMANCE, QUALITY OR NON-INFRINGEMENT OF ANY INTELLECTUAL PROPERTY RIGHT; ALL SUCH WARRANTIES ARE HEREBY EXPRESSLY DISCLAIMED. SKYWORKS DOES NOT WARRANT THE ACCURACY OR COMPLETENESS OF THE INFORMATION, TEXT, GRAPHICS OR OTHER ITEMS CONTAINED WITHIN THESE MATERIALS. SKYWORKS SHALL NOT BE LIABLE FOR ANY DAMAGES, INCLUDING BUT NOT LIMITED TO ANY SPECIAL, INDIRECT, INCIDENTAL, STATUTORY, OR CONSEQUENTIAL DAMAGES, INCLUDING WITHOUT LIMITATION, LOST REVENUES OR LOST PROFITS THAT MAY RESULT FROM THE USE OF THE MATERIALS OR INFORMATION, WHETHER OR NOT THE RECIPIENT OF MATERIALS HAS BEEN ADVISED OF THE POSSIBILITY OF SUCH DAMAGE.

Skyworks products are not intended for use in medical, lifesaving or life-sustaining applications, or other equipment in which the failure of the Skyworks products could lead to personal injury, death, physical or environmental damage. Skyworks customers using or selling Skyworks products for use in such applications do so at their own risk and agree to fully indemnify Skyworks for any damages resulting from such improper use or sale.

Customers are responsible for their products and applications using Skyworks products, which may deviate from published specifications as a result of design defects, errors, or operation of products outside of published parameters or design specifications. Customers should include design and operating safeguards to minimize these and other risks. Skyworks assumes no liability for applications assistance, customer product design, or damage to any equipment resulting from the use of Skyworks products outside of stated published specifications or parameters.

Skyworks, the Skyworks symbol, and "Breakthrough Simplicity" are trademarks or registered trademarks of Skyworks Solutions, Inc., in the United States and other countries. Third-party brands and names are for identification purposes only, and are the property of their respective owners. Additional information, including relevant terms and conditions, posted at www.skyworksinc.com, are incorporated by reference.