

Assembly Instructions for - 37245

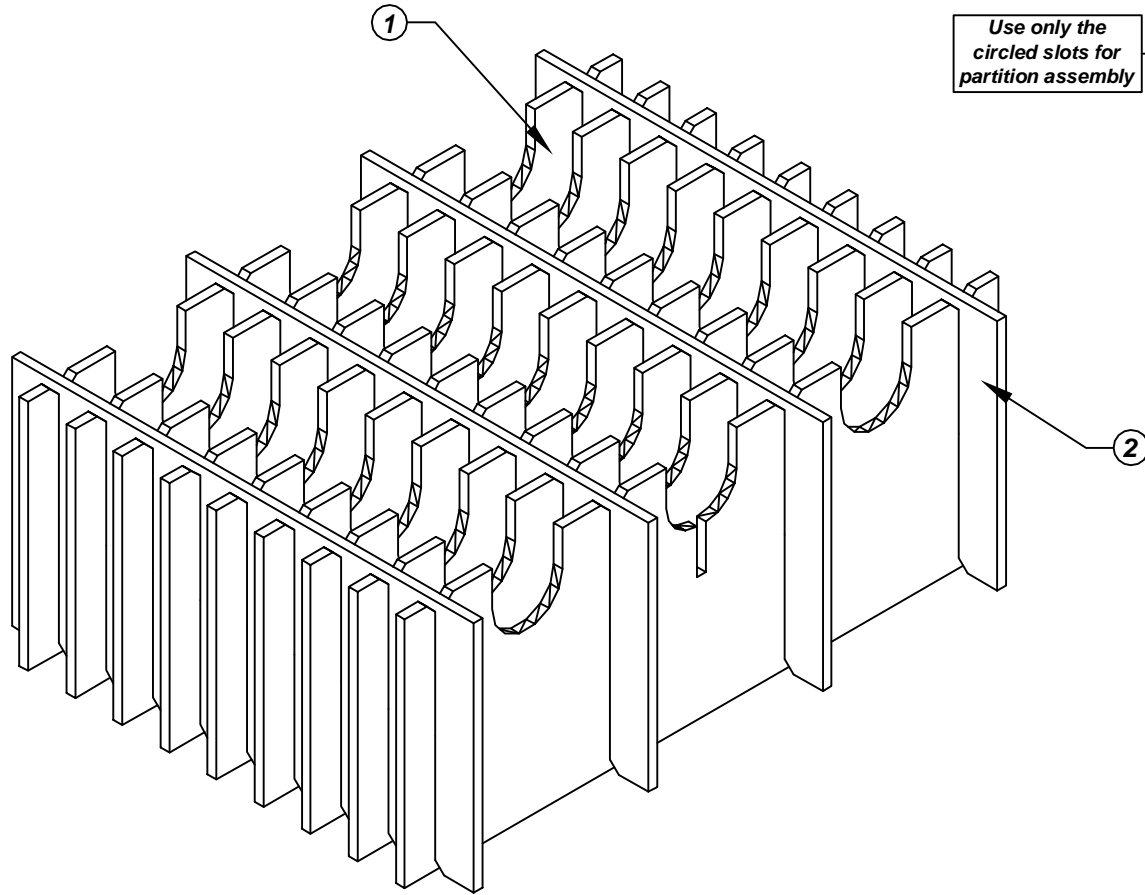

Use only the circled slots for partition assembly

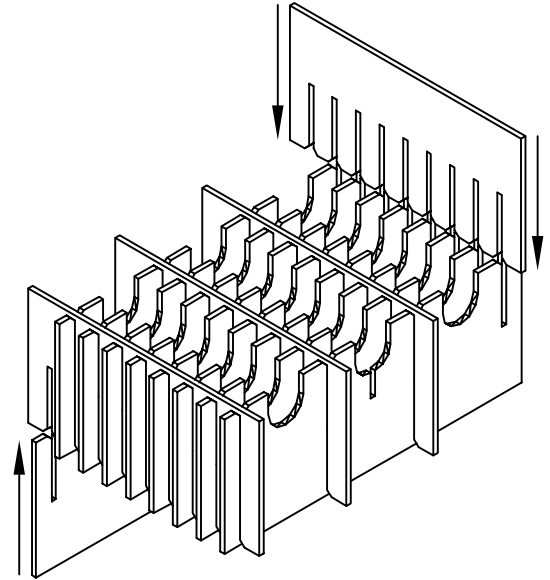
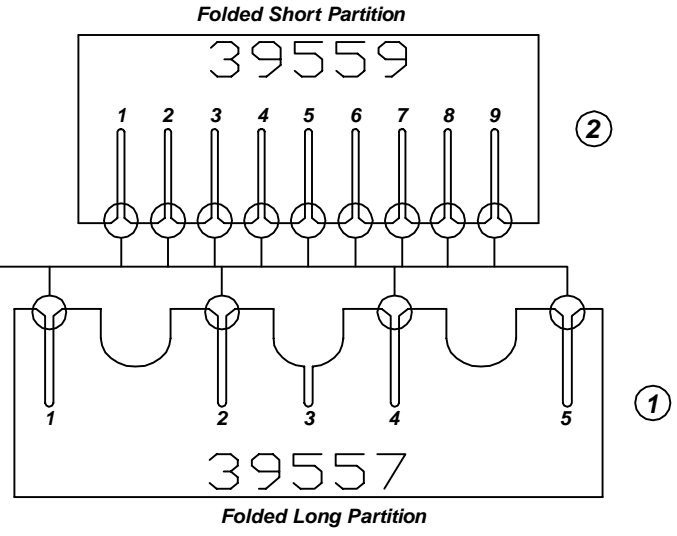

Made in America

F/N ①	Part # 39557	Dimensions: 13-7/16" x 16-7/8"	Description: 436/438 - LP Long Partition	Qty: 9
F/N ②	Part # 39559	Dimensions: 13-7/16" x 13-1/8"	Description: 436 - SP Short Partition	Qty: 4

37245 - 30 Cell Inplant Handler Cell Size - 6-3/4" x 4-5/8" x 1"

Notes:
For use with the following storage container & lid:
37511 - Storage Container
37551 - Lid

PROTEKTIVE PAK
13520 MONTE VISTA AVENUE, CHINO, CA 91710
PHONE (909) 627-2578, FAX (909) 363-7331
ProtektivePak.com



DRAWING NUMBER
IPH-37245

DATE
Dec.
2007