

**ebm-papst St. Georgen GmbH & Co. KG**

Hermann-Papst-Str. 1  
 D-78112 St. Georgen  
 Phone +49 (0) 7724 81-0  
 Fax +49 (0) 7724 81-1309  
 info2@de.ebmpapst.com  
 www.ebmpapst.com

**Nominal data**

Type	8412 NH-217	
Nominal voltage	VDC	12
Nominal voltage range	VDC	8 .. 15
Speed (rpm)	min <sup>-1</sup>	3600
Power consumption	W	2.5
Min. ambient temperature	°C	-20
Max. ambient temperature	°C	70
Air flow	m <sup>3</sup> /h	79
Sound power level	B	5.0
Sound pressure level	dB(A)	37

ml = Max. load · me = Max. efficiency · fa = Free air · cs = Customer specification · ce = Customer equipment  
 Subject to change



### Technical description

<b>Housing material</b>	Glass-fiber reinforced PBT plastic
<b>Impeller material</b>	Glass-fiber reinforced PA plastic
<b>Weight</b>	0.095 kg
<b>Dimensions</b>	80 x 80 x 25 mm
<b>Airflow direction</b>	Exhaust over struts
<b>Direction of rotation</b>	Counterclockwise, viewed toward rotor
<b>Storage</b>	Ball bearing
<b>Service life L10 at 40 °C</b>	70000 h
<b>Service life L10 at maximum temperature</b>	35000 h
<b>Cable</b>	Leads AWG 24, TR 64, stripped and tin-plated.
<b>Motor protection</b>	Protection against reverse polarity and blocked rotor.
<b>Locked-rotor protection</b>	Locked-rotor and overload protection
<b>Approval</b>	VDE, CSA, UL, CE
<b>Option</b>	Possible custom designs: Speed signal Go / No-go alarm Alarm with speed limit External temperature sensor Internal temperature sensor PWM control input Analog control input Moisture protection Degree of protection: IP54 / IP68

## Product drawing

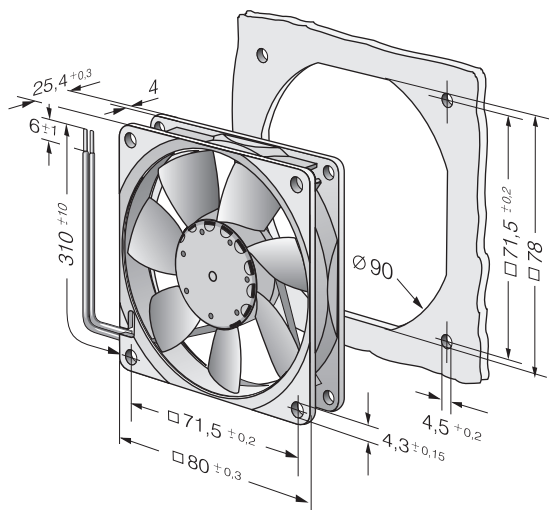

## Curves: Air performance

