

THIS COPY IS PROVIDED ON A RESTRICTED BASIS AND IS NOT TO BE USED IN ANY WAY DETRIMENTAL TO THE INTERESTS OF PANDUIT CORP.

Material	High Conductivity Seamless Copper Tube
Plating	Electro-Tin
Wire Size & Type	Stranded Copper Flex Cable; 3/0 AWG (450/24) Diesel Locomotive, 3/0 AWG FLEX K,M Class K & Class M
Wire Strip Length	1-7/16 in.
Stud Size	1/4 in.
UL Listed Wire Connector	Yes, for applications up to 35kv. Consult cable manufacturer for voltage stress relief instructions with applications greater than 2000 volts.
UL Temperature Rating	90° C
C.S.A Certified Wire Connector	Yes
Panduit Color Code on Barrel	PURPLE
Panduit Die Index No. on Barrel	P54
Alternate Industry Die Index No. () on Barrel	(15)

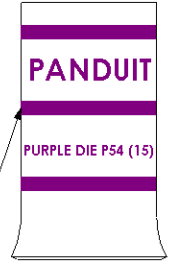

Color coded barrel markings

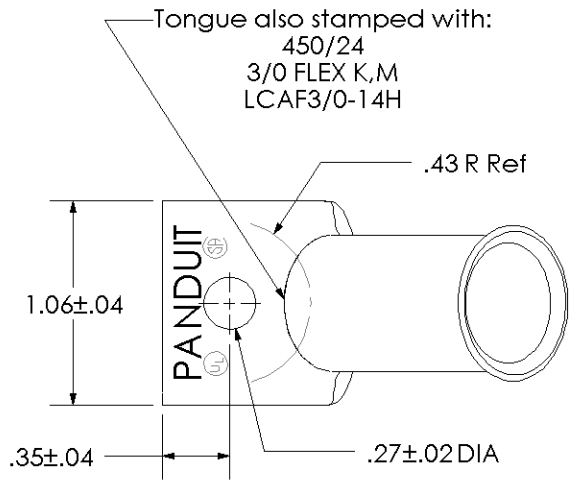
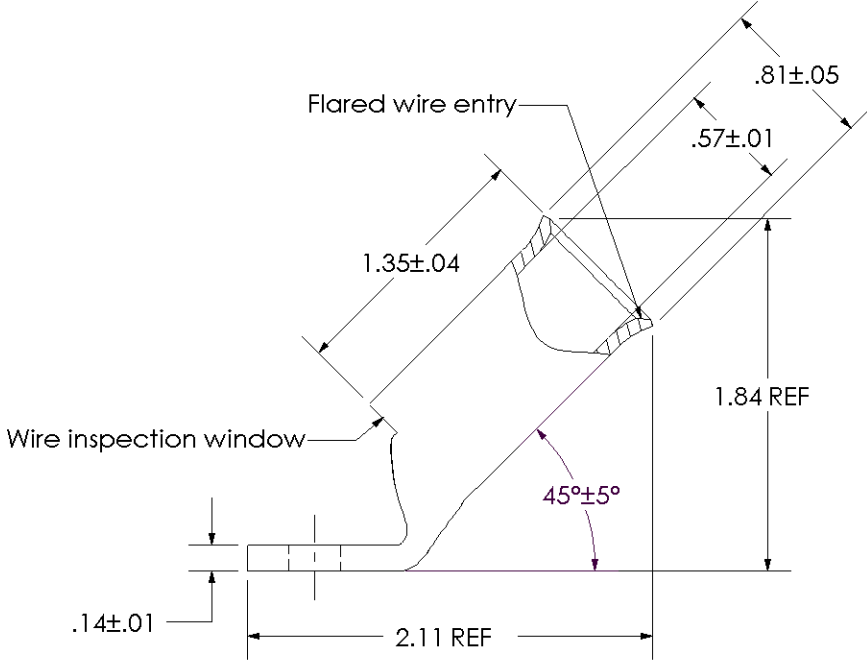

00	8/02	SAB	DRL	RELEASED	10322
REV	DATE	BY	CHK	DESCRIPTION	ECN

PANDUIT CORP. TINLEY PARK, ILLINOIS

LCAF3/0-14H-X
Copper Lug - One-Hole, Flared Barrel, 45° Angle Tongue

SCALE N/A DRAWING NO / CAD FILE LCAF3_0-14H-CUST