



Micro Commercial Components



Micro Commercial Components  
 20736 Marilla Street Chatsworth  
 CA 91311  
 Phone: (818) 701-4933  
 Fax: (818) 701-4939

# FS1AE THRU FS1ME

## Features

- Lead Free Finish/Rohs Compliant (Note1) ("P" Suffix designates Compliant. See ordering information)
- Halogen free available upon request by adding suffix "-HF"
- Epoxy meets UL 94 V-0 flammability rating
- Moisture Sensitivity Level 1
- Easy Pick And Place
- High Temp Soldering: 260°C for 10 Seconds At Terminals
- Superfast Recovery Times For High Efficiency

## Maximum Ratings

- Operating Temperature: -50°C to +150°C
- Storage Temperature: -50°C to +150°C
- Maximum Thermal Resistance; 15°C/W Junction To Lead
- Maximum Thermal Resistance; 88°C/W Junction To Ambient

MCC Catalog Number	Device Marking	Maximum Recurrent Peak Reverse Voltage	Maximum RMS Voltage	Maximum DC Blocking Voltage
FS1AE	FS1A	50V	35V	50V
FS1BE	FS1B	100V	70V	100V
FS1DE	FS1D	200V	140V	200V
FS1GE	FS1G	400V	280V	400V
FS1JE	FS1J	600V	420V	600V
FS1KE	FS1K	800V	560V	800V
FS1ME	FS1M	1000V	700V	1000V

## Electrical Characteristics @ 25°C Unless Otherwise Specified

Average Forward current	$I_{F(AV)}$	1.0A	$T_a = 90^\circ\text{C}$
Peak Forward Surge Current	$I_{FSM}$	30A	8.3ms, half sine
Maximum Instantaneous Forward Voltage	$V_F$	1.30V	$I_{FM} = 1.0A;$ $T_J = 25^\circ\text{C}^*$
Maximum DC Reverse Current At Rated DC Blocking Voltage	$I_R$	5 $\mu\text{A}$ 200 $\mu\text{A}$	$T_J = 25^\circ\text{C}$ $T_J = 125^\circ\text{C}$
Maximum Reverse Recovery Time	$T_{rr}$	150ns 250ns 500ns	$I_F=0.5A, I_R=1.0A,$ $I_{rr}=0.25A$
Typical Junction Capacitance	$C_J$	50pF	Measured at 1.0MHz, $V_R=4.0V$

\*Pulse test: Pulse width 200  $\mu\text{sec}$ , Duty cycle 2%

Note: 1. High Temperature Solder Exemptions Applied, see EU Directive Annex 7.

## 1 Amp Fast Recovery Silicon Rectifier 50 to 1000 Volts

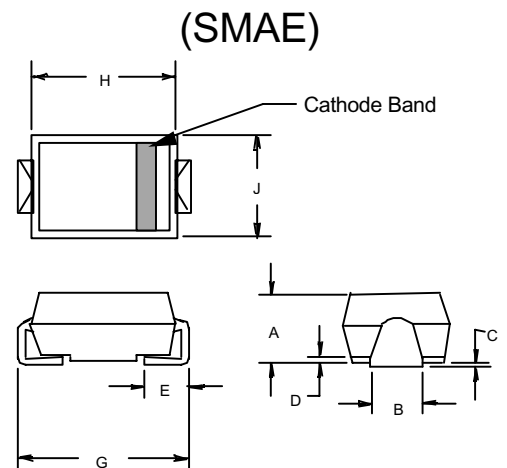

DIM	INCHES		MM		NOTE
	MIN	MAX	MIN	MAX	
A	.079	.096	2.01	2.44	
B	.050	.075	1.27	1.90	
C	.002	.008	.05	.20	
D	---	.02	---	.51	
E	.030	.060	.76	1.52	
G	.189	.208	4.80	5.30	
H	.157	.180	4.00	4.57	
J	.090	.115	2.29	2.92	

### SUGGESTED SOLDER PAD LAYOUT

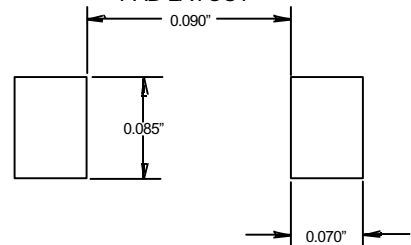

# FS1AE thru FS1ME

Figure 1  
Typical Forward Characteristics

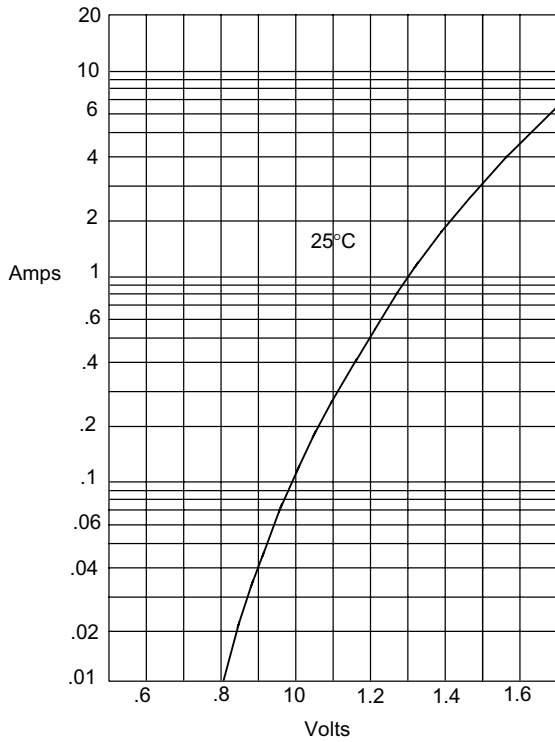

Instantaneous Forward Current - Amperes *versus*  
Instantaneous Forward Voltage - Volts

Figure 2  
Forward Derating Curve

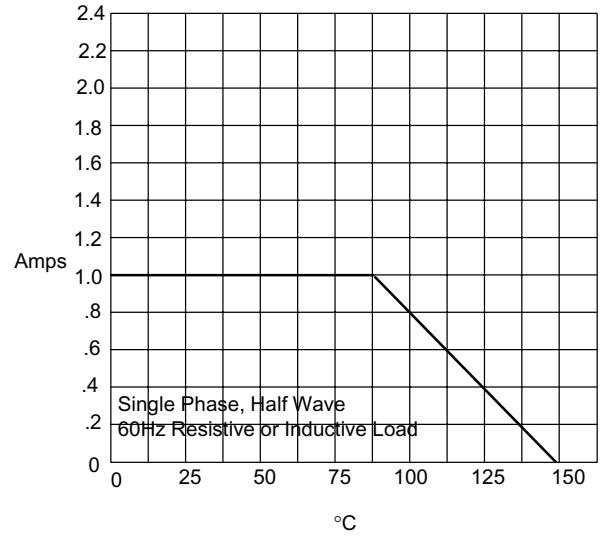

Average Forward Rectified Current - Amperes *versus*  
Ambient Temperature - °C

Figure 3  
Junction Capacitance

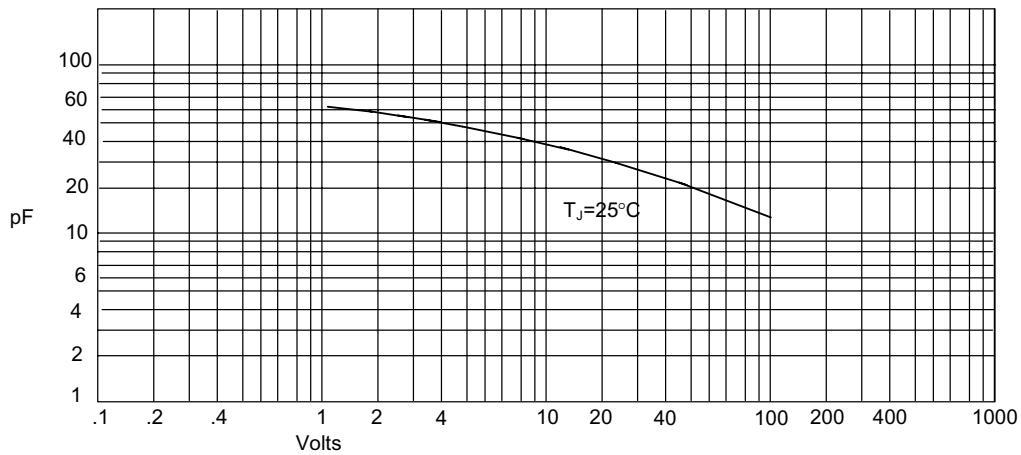

Junction Capacitance - pF *versus*  
Reverse Voltage - Volts

# FS1AE thru FS1ME

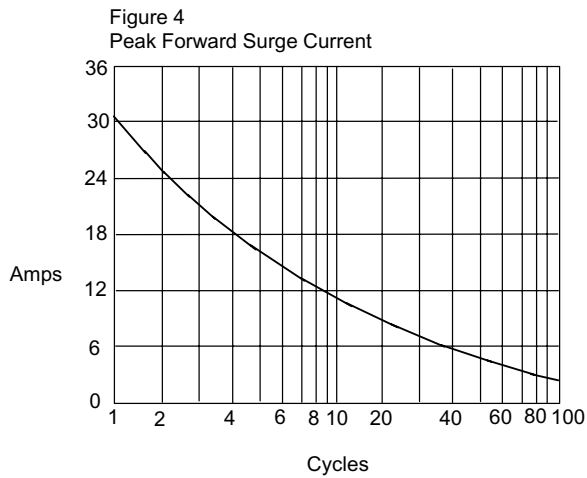

Peak Forward Surge Current - Amperes *versus* Number Of Cycles At 60Hz - Cycles

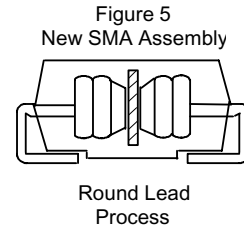
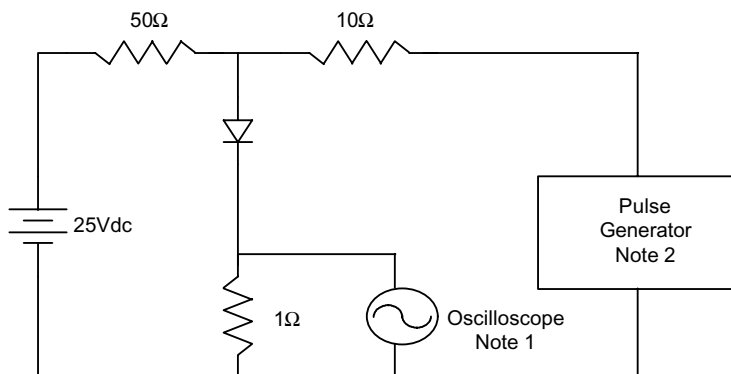

Figure 6  
Reverse Recovery Time Characteristic And Test Circuit Diagram



- Notes:
1. Rise Time = 7ns max.  
Input impedance = 1 megohm, 22pF
  2. Rise Time = 10ns max.
  3. Resistors are non-inductive

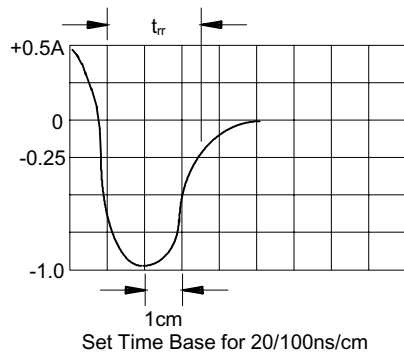
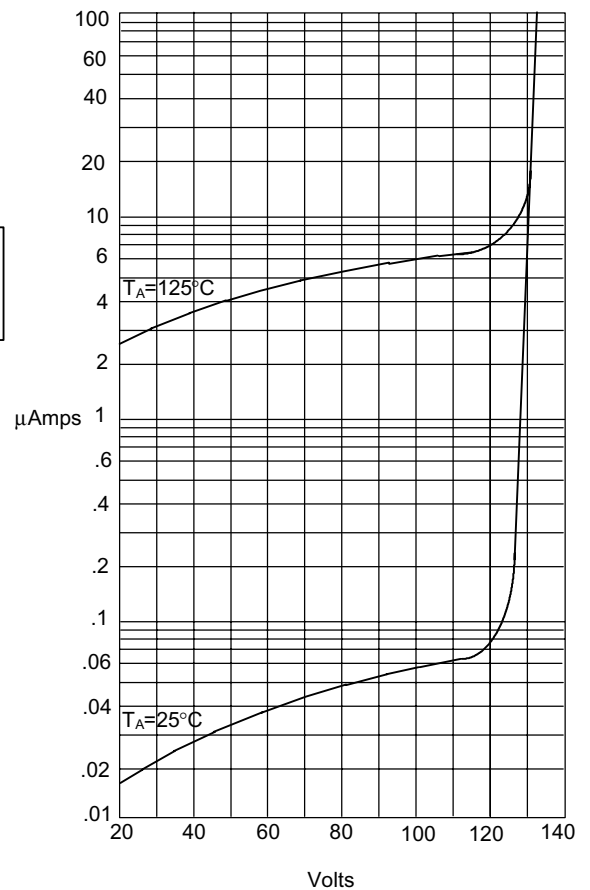

Figure 7  
Typical Reverse Characteristics



Instantaneous Reverse Leakage Current - MicroAmperes *versus* Percent Of Rated Peak Reverse Voltage - Volts



Micro Commercial Components

### Ordering Information :

Device	Packing
Part Number-TP	Tape&Reel: 6Kpcs/Reel

Note : Adding "-HF" suffix for halogen free, eg. Part Number-TP-HF

#### \*\*\*IMPORTANT NOTICE\*\*\*

**Micro Commercial Components Corp.** reserves the right to make changes without further notice to any product herein to make corrections, modifications , enhancements , improvements , or other changes . **Micro Commercial Components Corp .** does not assume any liability arising out of the application or use of any product described herein; neither does it convey any license under its patent rights ,nor the rights of others . The user of products in such applications shall assume all risks of such use and will agree to hold **Micro Commercial Components Corp .** and all the companies whose products are represented on our website, harmless against all damages.

#### \*\*\*LIFE SUPPORT\*\*\*

MCC's products are not authorized for use as critical components in life support devices or systems without the express written approval of Micro Commercial Components Corporation.

#### \*\*\*CUSTOMER AWARENESS\*\*\*

Counterfeiting of semiconductor parts is a growing problem in the industry. Micro Commercial Components (MCC) is taking strong measures to protect ourselves and our customers from the proliferation of counterfeit parts. MCC strongly encourages customers to purchase MCC parts either directly from MCC or from Authorized MCC Distributors who are listed by country on our web page cited below. Products customers buy either from MCC directly or from Authorized MCC Distributors are genuine parts, have full traceability, meet MCC's quality standards for handling and storage. **MCC will not provide any warranty coverage or other assistance for parts bought from Unauthorized Sources.** MCC is committed to combat this global problem and encourage our customers to do their part in stopping this practice by buying direct or from authorized distributors.

[www.mccsemi.com](http://www.mccsemi.com)