

THIS DRAWING IS UNPUBLISHED. RELEASED FOR PUBLICATION
 © COPYRIGHT - By - ALL RIGHTS RESERVED.

| LOC | DIST | REVISIONS | | | |
|-----|------|-------------|-------------------------|-----------|---------|
| P | LTR | DESCRIPTION | DATE | DWN | APVD |
| DW | | B2 | REVISED (ECR-11-017441) | 22AUG2011 | S.Y H.K |

2023519-1: AS SHOWN

- NOTE:**
- ① MATERIAL:
 - ① HOUSING: HIGH TEMP. THERMOPLASTIC(LCP), WITH G/F, UL 94V-0, COLOR: BLACK.
 - ② CONTACT: COPPER ALLOY
 - ③ CAP: HIGH TEMP. THERMOPLASTIC, UL 94V-0, COLOR: BLACK.
 - ② FINISH:
 - CONTACT: AU 0.762um [30u"] MIN. ON THE CONTACT AREA.
 - MATT TIN 2.54um [100u"] MIN. ON THE SOLDER TAIL AREA.
 - NI 1.27 um [50u"] MIN. UNDER PLATED OVERALL.
 - 3. REFLOW SOLDER CAPABLE TO 260°C PER TE TEST SPEC. 109-201, CONDITION B.
 - ④ NO ACCUMULATIVE TOLERANCES.

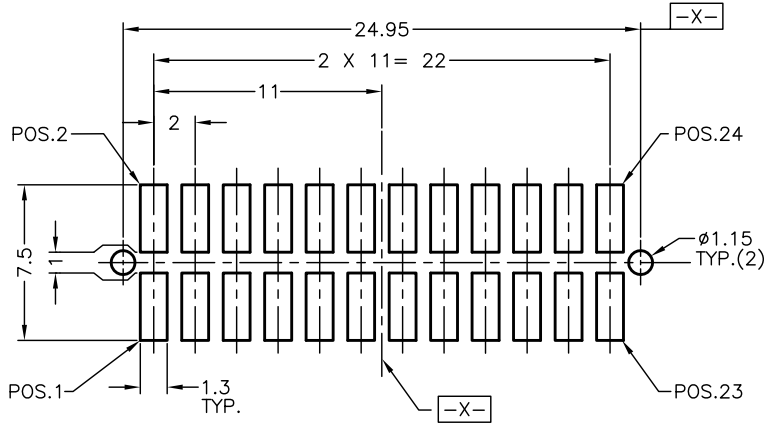
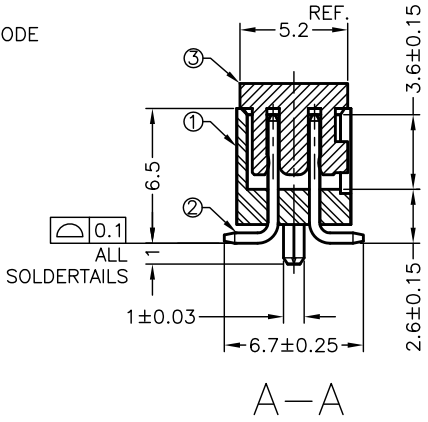
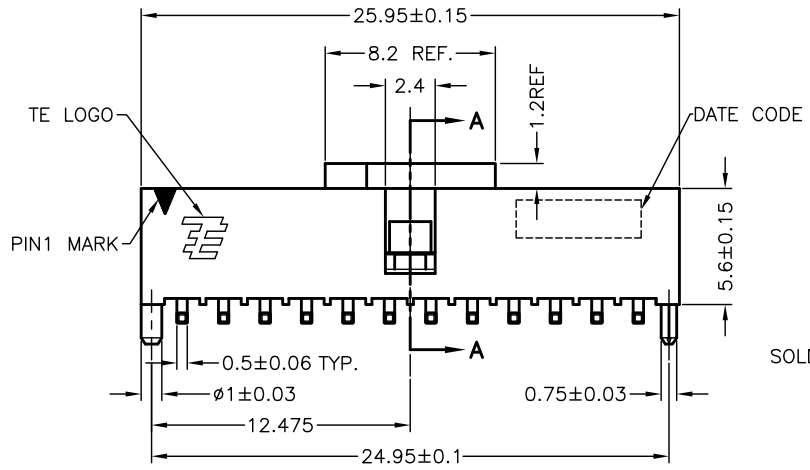
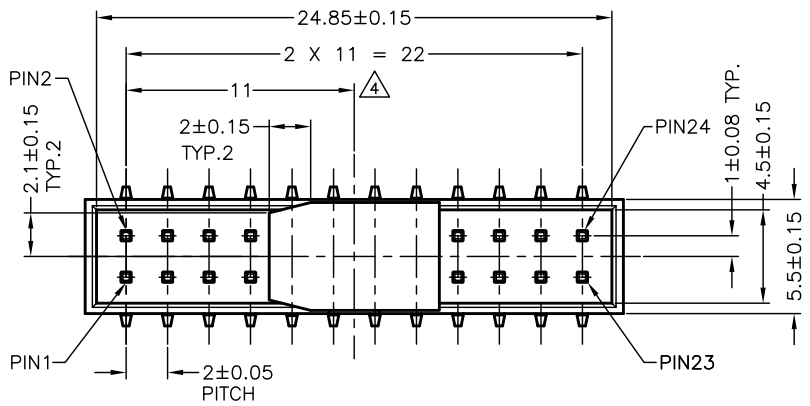

RECOMMENDED PCB LAYOUT
TOLERANCE: ±0.05

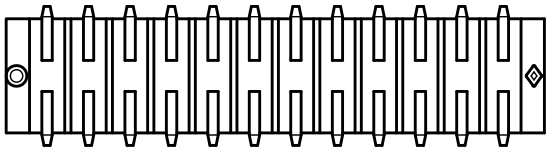

| | | | | |
|--|--|--------------------------------|--|--|
| THIS DRAWING IS A CONTROLLED DOCUMENT. | | DWN S. YANG 22JUN2009 | | |
| | | CHK M. CHAO 22JUN2009 | | |
| DIMENSIONS: mm | | APVD H. KODAMA 22JUN2009 | NAME AMPMODU 2.00MM PITCH DUAL ROW PLUG SMT-TYPE CONN. | |
| TOLERANCES UNLESS OTHERWISE SPECIFIED: 3. PLC ± 1. PLC ±0.25 2. PLC ± 5. PLC ±3' 4. PLC ± ANGLES ± | | PRODUCT SPEC 108-99023 | DRAWING NO A3 00779 | |
| MATERIAL ① | | APPLICATION SPEC | RESTRICTED TO | |
| FINISH ② | | WEIGHT 1.13 g | SCALE 4:1 | |
| | | CUSTOMER DRAWING | SHEET 1 OF 2 | |
| | | | REV B2 | |

THIS DRAWING IS UNPUBLISHED.

RELEASED FOR PUBLICATION

ALL RIGHTS RESERVED.

© COPYRIGHT -- By --

LOC DW

DIST

REVISIONS

| P | LTR | DESCRIPTION | DATE | DWN | APVD |
|---|-----|-------------|------|-----|------|
| - | - | SEE SHEET 1 | | | |

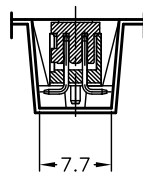
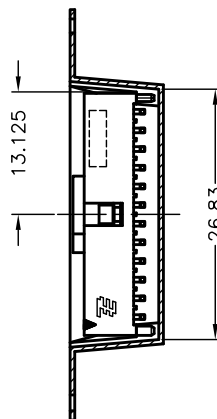
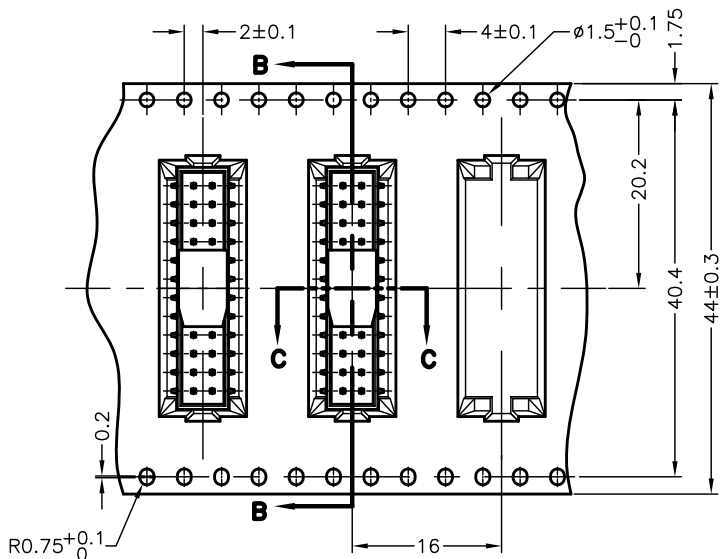

B-B

C-C

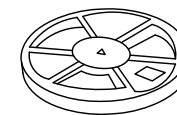

4 REELS/ BOX



AIR CAP
4 PCS

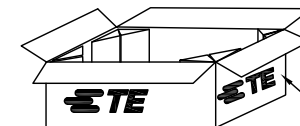

SHIPPING
BOX

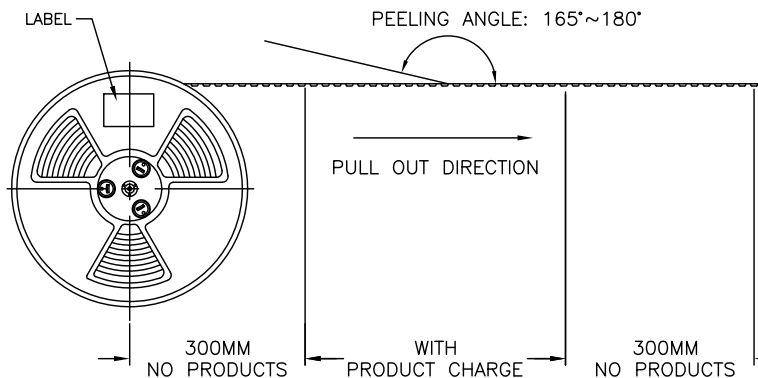
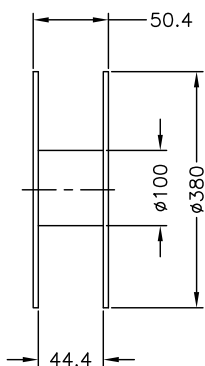
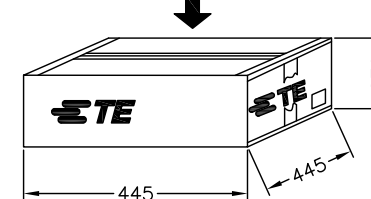
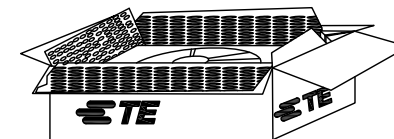

| | | | | |
|-----------------|---------------|----------|-----------|--------------------|
| 6.69 | 2.26 | 2000 | 500 | 4 |
| KG/GROSS WEIGHT | KG/NET WEIGHT | PCS/ BOX | PCS/ REEL | REEL/ SHIPPING BOX |

THIS DRAWING IS A CONTROLLED DOCUMENT.

| | | | |
|--|---|---|--------------------|
| DIMENSIONS: mm | TOLERANCES UNLESS OTHERWISE SPECIFIED: ±0.5 ±3° | TE Connectivity AMPMODU 2.00MM PITCH DUAL ROW PLUG SMT-TYPE CONN. | |
| MATERIAL PS | FINISH | SIZE A3 | CAGE CODE 00779 |
| THIS DRAWING IS A CONTROLLED DOCUMENT. DIMENSIONS: mm TOLERANCES UNLESS OTHERWISE SPECIFIED: ±0.5 ±3° MATERIAL: PS FINISH: | | DRAWING NO 2023519 SCALE: FREE SHEET: 2 OF 2 REV: B2 | RESTRICTED TO |

CUSTOMER DRAWING