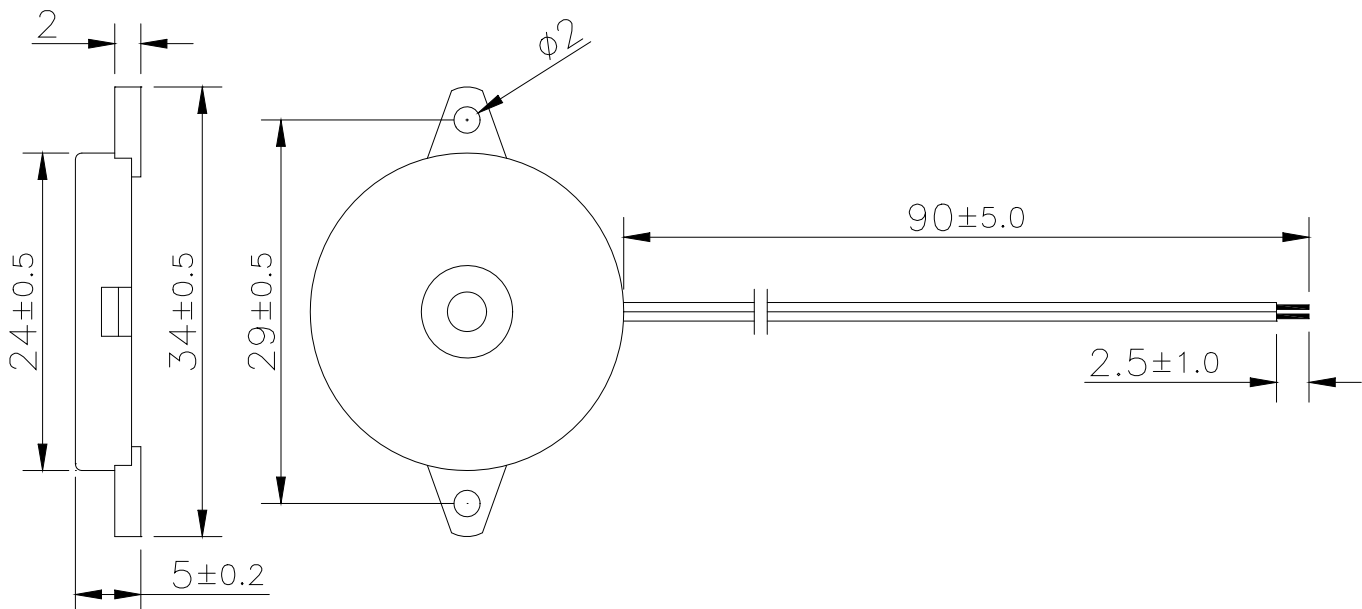

Sales Outline DrawingRevision **B****Specifications:**

Resonant Frequency (Hz)	3800 ± 500
Operating Voltage (Vp-p/max)	30
Rated Voltage (Vp-p)	5.0
Current Consumption (mA/max)	5.0 at Rated Voltage
Sound Pressure Level (dB/min)	90 at 10cm at Rated voltage
Capacitance (pF)	25,000 ± 30% at 120 Hz
Operating Temperature (°C)	-20 ~ +70
Storage Temperature (°C)	-30 ~ +80
Housing	ABS757 UL94HB plastic resin (Color: Black)
Lead Wires	32 AWG
Weight (Grams)	2.0
Condition by wave soldering (°C)	245 ± 5 / 3 ± 0.5 sec
Condition by hand soldering (°C)	350 ± 20 / within 5 sec
Options	For other options contact factory

Dimensions: (units: mm)**ROHS Compliant**

Direct Drive Transducer Operation:

Direct drive transducer devices do not have any included DC circuitry, so the user must apply a sine or square wave with the appropriate rated frequency. A square wave will typically result in more sound level than a sine wave. The higher the peak-to-peak voltage applied (up to the maximum rated voltage), the higher the resulting sound level.

Frequency Response:

