

G2-LAURA-SS-P

~11° smooth spot beam. Assembly with thinner white holder, installation tape and location pins.

TECHNICAL SPECIFICATIONS:

Dimensions	21.6 mm
Height	13.1 mm
Fastening	tape, pin
Colour	white
Box size	
Box weight	6 kg
Quantity in Box	pcs
ROHS compliant	yes ⓘ

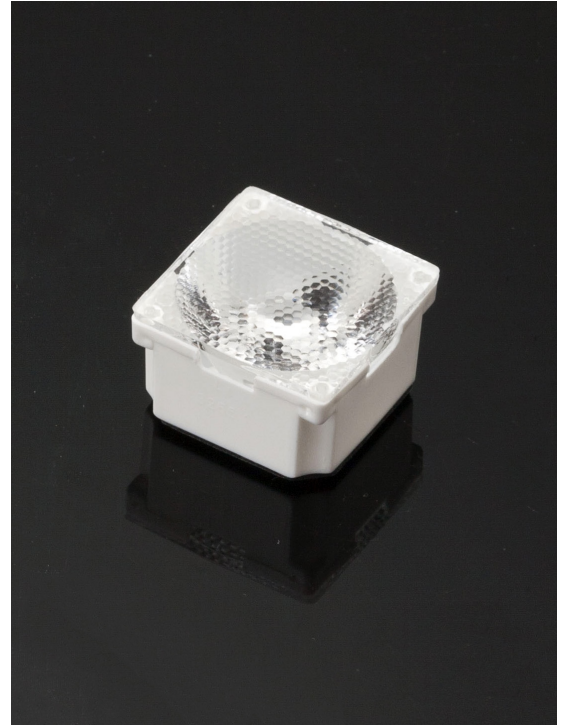

MATERIAL SPECIFICATIONS:

Component	Type	Material	Colour
LAURA-SS	Lens	PMMA	
LAURA-LT-PIN-XP-HLD-WHT	Holder	PC	white
ROSE-TAPE	Tape	PU tape	black

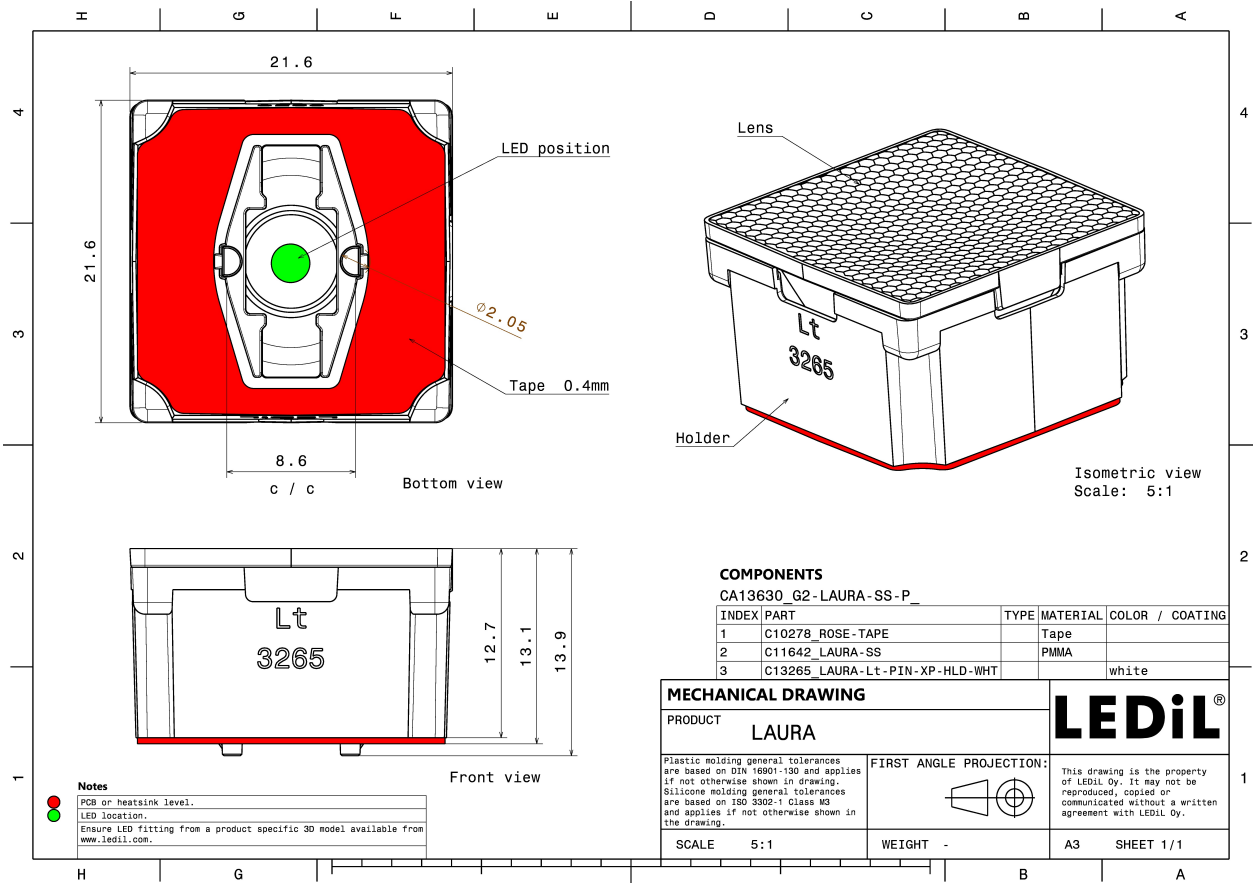

PHOTOMETRIC DATA (MEASURED):



LED XB-D
FWHM 13.0°
Efficiency 88 %
Peak intensity 13.500 cd/lm
Required components:

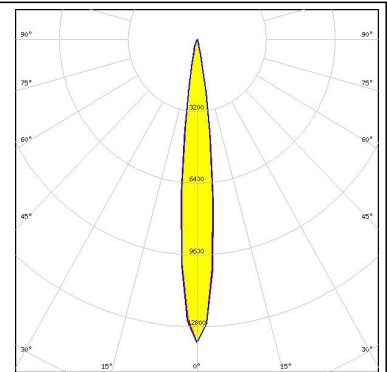
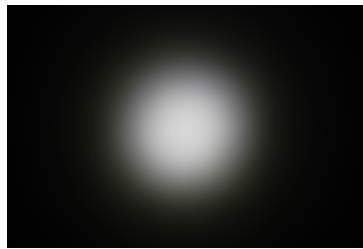

LED XB-H
FWHM 13.0°
Efficiency 90 %
Peak intensity 13.300 cd/lm
Required components:

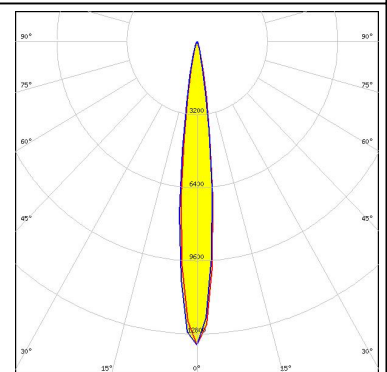

LED XP-E
FWHM 11.0°
Efficiency 93 %
Peak intensity 16.500 cd/lm
Required components:

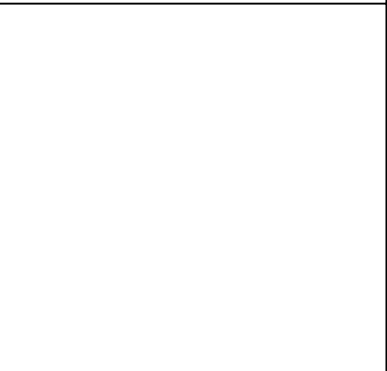

LED XP-E2
FWHM 12.0°
Efficiency 90 %
Peak intensity 17.400 cd/lm
Required components:

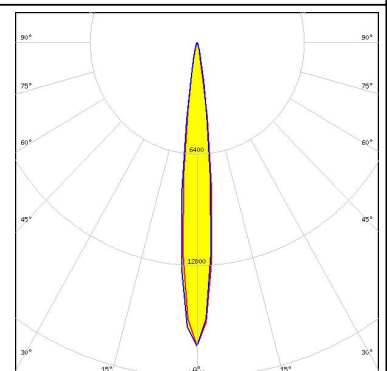

PHOTOMETRIC DATA (MEASURED):



LED XP-G2
FWHM 13.0°
Efficiency 90 %
Peak intensity 14.000 cd/lm
Required components:

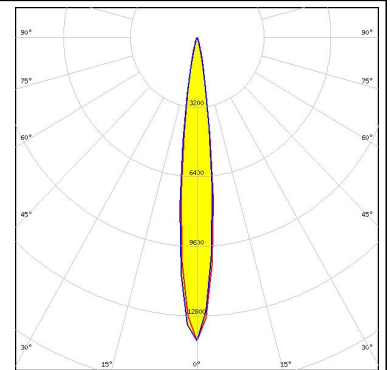

LED XP-L
FWHM 16.0°
Efficiency 89 %
Peak intensity 8.500 cd/lm
Required components:

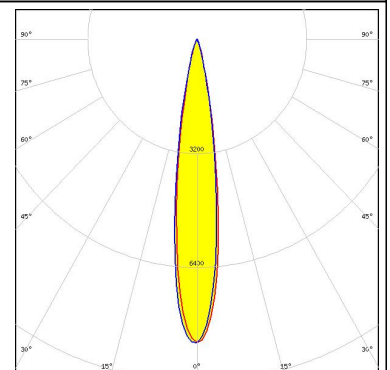
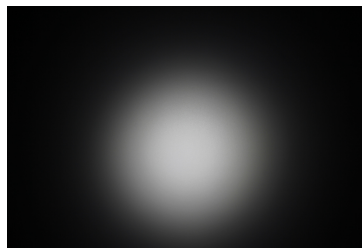



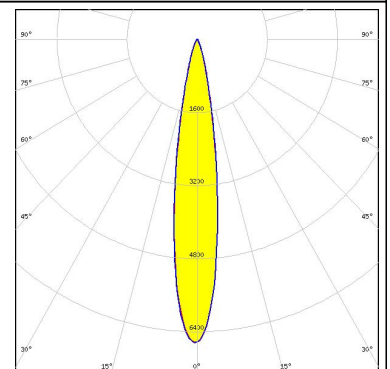
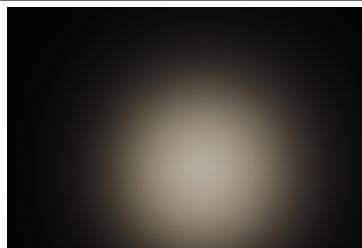

LED XP-L2
FWHM 17.0°
Efficiency 88 %
Peak intensity 6.600 cd/lm
Required components:

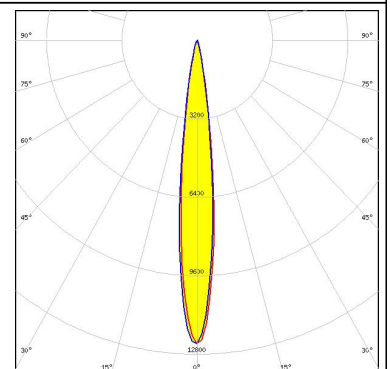

LED XT-E
FWHM 13.0°
Efficiency 90 %
Peak intensity 12.400 cd/lm
Required components:

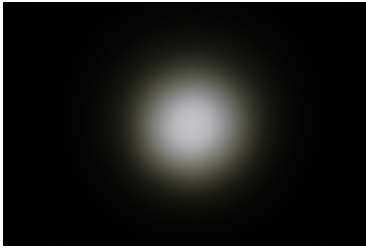
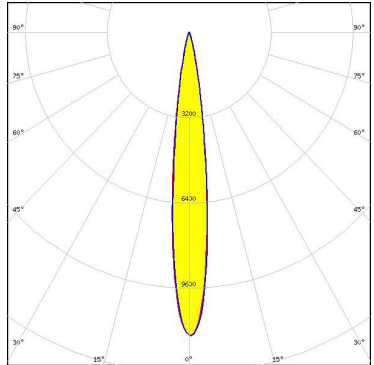
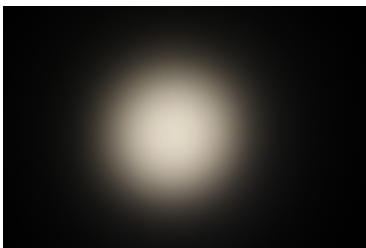
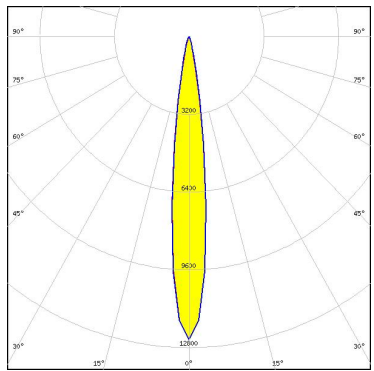

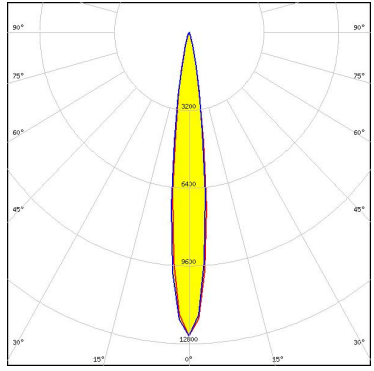
PHOTOMETRIC DATA (MEASURED):

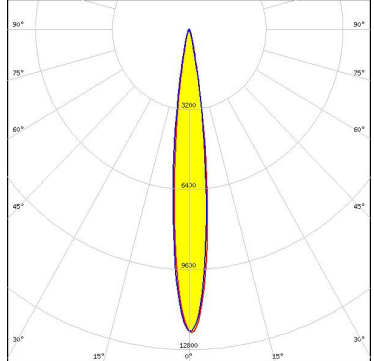
<p>LUMILEDS</p> <p>LED LUXEON 3030 2D (Round LES)</p> <p>FWHM 13.0°</p> <p>Efficiency 91 %</p> <p>Peak intensity 11.400 cd/lm</p> <p>Required components:</p>		
<p>LUMILEDS</p> <p>LED LUXEON TX</p> <p>FWHM 14.0°</p> <p>Efficiency 90 %</p> <p>Peak intensity 12.500 cd/lm</p> <p>Required components:</p>		
<p>NICHIA</p> <p>LED NCSxx19A</p> <p>FWHM 14.0°</p> <p>Efficiency 91 %</p> <p>Peak intensity 12.500 cd/lm</p> <p>Required components:</p>		
<p>NICHIA</p> <p>LED NVSW219D</p> <p>FWHM 13.0°</p> <p>Efficiency 94 %</p> <p>Peak intensity 12.200 cd/lm</p> <p>Required components:</p>		

PHOTOMETRIC DATA (MEASURED):



LED NVSxx19A
FWHM 15.0°
Efficiency 88 %
Peak intensity 10.400 cd/lm
Required components:

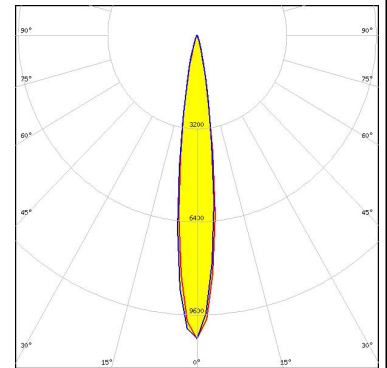

LED NVSxx19B/NVSxx19C
FWHM 14.0°
Efficiency 89 %
Peak intensity 11.400 cd/lm
Required components:

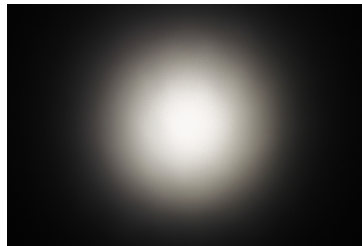

LED Oslon Square EC
FWHM 13.0°
Efficiency 90 %
Peak intensity 13.200 cd/lm
Required components:

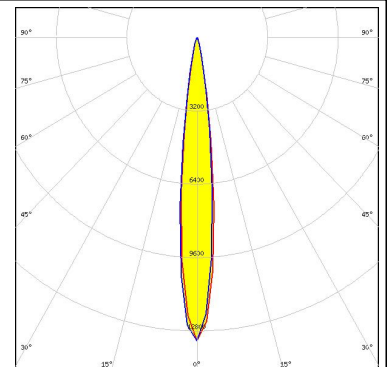
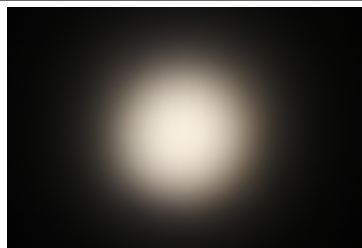

LED Z5M1/Z5M2
FWHM 12.0°
Efficiency 90 %
Peak intensity 13.140 cd/lm
Required components:

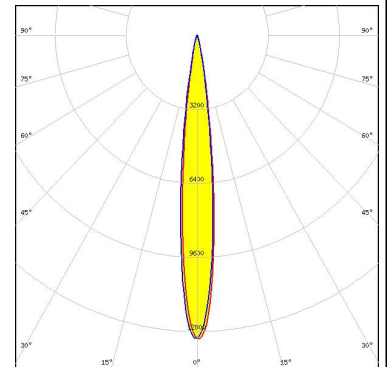

PHOTOMETRIC DATA (SIMULATED):



LED XHP35 HI
FWHM 14.0°
Efficiency 94 %
Peak intensity 12.800 cd/lm
Required components:

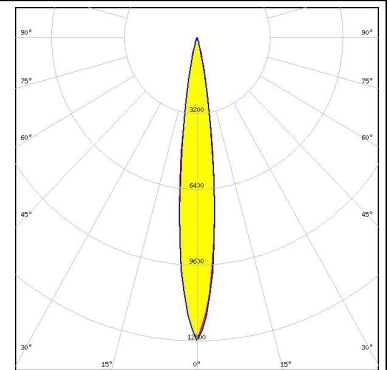

LED Oslon Black
FWHM 13.0°
Efficiency 96 %
Peak intensity 13.800 cd/lm
Required components:

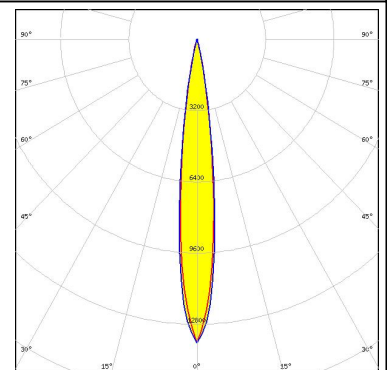

LED Oslon Black Flat
FWHM 11.0°
Efficiency 94 %
Peak intensity 21.300 cd/lm
Required components:

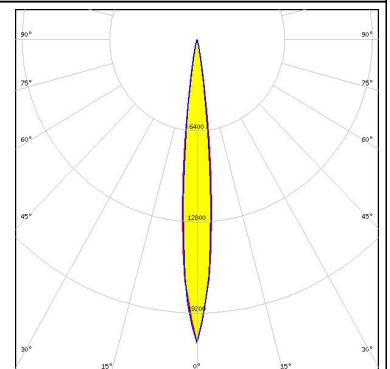

LED Oslon Square Flat
FWHM 12.0°
Efficiency 94 %
Peak intensity 17.170 cd/lm
Required components:

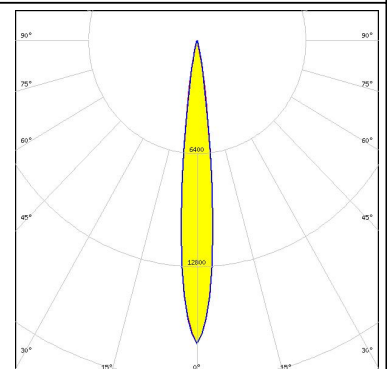
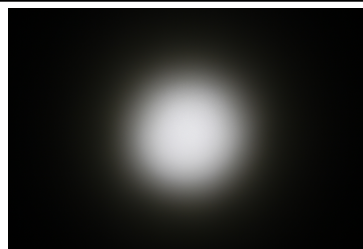

PHOTOMETRIC DATA (SIMULATED):

OSRAM
Opto Semiconductors

LED SFH 4770S
FWHM 13.0°
Efficiency 94 %
Peak intensity cd/lm
Required components:

SEKUL
SEOUL SEMICONDUCTOR

LED Z8Y22P
FWHM 13.0°
Efficiency 97 %
Peak intensity 11.850 cd/lm
Required components:

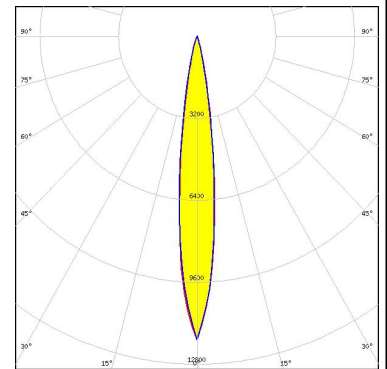

GENERAL INFORMATION:

NOTE: The typical beam angle will be changed by different color, chip size and chip position tolerance. The typical total beam angle is the full angle measured where the luminous intensity is half of the peak value.

MATERIALS:

As part of our continuous research and improvement processes, and to ensure the best possible quality and availability of our products, LEDiL reserves the right to change material grades without notice.

PRODUCT DATA USER AGREEMENT AND DISCLAIMER:

The measured data in the provided downloadable LEDiL Product Datasheets and Mechanical 2D-Drawings is rounded and provided as reference for planning. LEDiL Oy's optical specifications have been verified by conducting performance testing of the products in accordance with the company's quality system. The reported data are averaged results of multiple measurements with typical variation. LEDiL Oy reserves the right to without prior notification make changes and improvements to its products.

LEDiL Oy assumes neither warranty, nor guarantee nor any other liability of any kind for the contents and correctness of the provided data. The provided data has been generated with highest diligence but the provided data may in reality not represent the complete possible variation range of all intrinsic parameters. Therefore, in certain cases a deviation from the provided data could occur.

LEDiL Oy reserves the right to undertake technical changes of its products without further notification which could lead to changes in the provided data. LEDiL Oy assumes no liability of any kind for the possible deviation from any provided data or any other damage resulting from the usage of the provided data.

The user agrees to this disclaimer and user agreement with the download or usage of the provided files.

LEDiL Oy

Joensuunkatu 13
FI-24240 SALO
Finland

LEDiL Inc.

228 West Page Street
Suite D
Sycamore IL 60178
USA

Local sales and technical support

[www.ledil.com/
where_to_buy](http://www.ledil.com/where_to_buy)

Shipping locations

Salo, Finland
Hong Kong, China

Distribution Partners

[www.ledil.com/
where_to_buy](http://www.ledil.com/where_to_buy)