



Is Now Part of



ON Semiconductor®

To learn more about ON Semiconductor, please visit our website at
www.onsemi.com

ON Semiconductor and the ON Semiconductor logo are trademarks of Semiconductor Components Industries, LLC dba ON Semiconductor or its subsidiaries in the United States and/or other countries. ON Semiconductor owns the rights to a number of patents, trademarks, copyrights, trade secrets, and other intellectual property. A listing of ON Semiconductor's product/patent coverage may be accessed at www.onsemi.com/site/pdf/Patent-Marking.pdf. ON Semiconductor reserves the right to make changes without further notice to any products herein. ON Semiconductor makes no warranty, representation or guarantee regarding the suitability of its products for any particular purpose, nor does ON Semiconductor assume any liability arising out of the application or use of any product or circuit, and specifically disclaims any and all liability, including without limitation special, consequential or incidental damages. Buyer is responsible for its products and applications using ON Semiconductor products, including compliance with all laws, regulations and safety requirements or standards, regardless of any support or applications information provided by ON Semiconductor. "Typical" parameters which may be provided in ON Semiconductor data sheets and/or specifications can and do vary in different applications and actual performance may vary over time. All operating parameters, including "Typicals" must be validated for each customer application by customer's technical experts. ON Semiconductor does not convey any license under its patent rights nor the rights of others. ON Semiconductor products are not designed, intended, or authorized for use as a critical component in life support systems or any FDA Class 3 medical devices or medical devices with a same or similar classification in a foreign jurisdiction or any devices intended for implantation in the human body. Should Buyer purchase or use ON Semiconductor products for any such unintended or unauthorized application, Buyer shall indemnify and hold ON Semiconductor and its officers, employees, subsidiaries, affiliates, and distributors harmless against all claims, costs, damages, and expenses, and reasonable attorney fees arising out of, directly or indirectly, any claim of personal injury or death associated with such unintended or unauthorized use, even if such claim alleges that ON Semiconductor was negligent regarding the design or manufacture of the part. ON Semiconductor is an Equal Opportunity/Affirmative Action Employer. This literature is subject to all applicable copyright laws and is not for resale in any manner.



FAN4603

600mA, Fully Integrated, Buck Power Supply Module

Features

- Solder and Play DC/DC Converter; No External Components Required
- Up to 91% Efficiency
- 600mA Output Current Capability
- 2.3V to 5.5V Input Voltage Range
- Fixed Output Voltages from 1.0V to 1.8V
- 35µA PFM Quiescent Current
- Best-in-Class Load and Line Transient Response
- ±2% PWM DC Voltage Accuracy
- No External Components Required
- High-Efficiency, Low-Ripple, Light-Load PFM
- Thermal Shutdown (TSD), Under-Voltage Lockout, (UVLO), and Short-Circuit (SCP) Protection
- 4.0 x 2.5mm MLP Package
- Maximum Height: 1.1mm

Applications

- POL and Distributed DC-DC Module Applications
- Small Form Factor, Battery-Powered Applications
- POL Core Power for FPGA, DSP, CPU, and GPU with Fast-Transient, Wide Dynamic Load Requirements
- Wireless Cards, Meters, Hearing Aids, Bluetooth Headsets, POS Equipment, VOIP, PDAs, MIDs, Netbooks, and Servers

Description

The FAN4603 is a fully integrated synchronous DC/DC buck converter that provides up to 600mA of output current over an input voltage ranging from 2.3V to 5.5V. It provides a fixed output voltage level ranging from 1.0V to 1.8V. Other voltage options are available on request.

The FAN4603 converter is offered as an ultra-miniature “Solder and Play” solution that requires no external components and is able to achieve a DC accuracy of ±2% PWM and an output ripple less than 12mV.

Total footprint is 4.0 x 2.5mm with a maximum height of 1.1mm. It can be used in small battery-powered devices and applications with distributed DC POL requirements.

At moderate and light loads, pulse frequency modulation is used to operate the device in power-save mode with a typical quiescent current of 35µA. Even with such a low quiescent current, the part exhibits excellent transient response during large load swings. At higher loads, the system automatically switches to fixed-frequency control.

In shutdown mode, the supply current drops below 2µA, reducing power consumption.

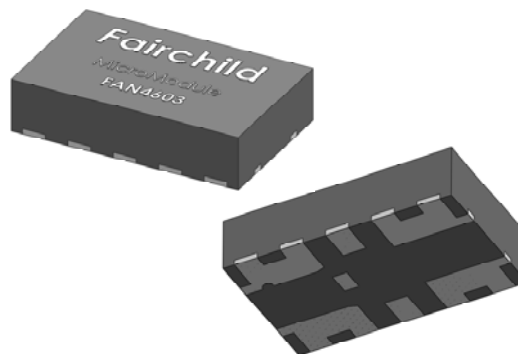

Ordering Information

Part Number	Output Voltage ⁽¹⁾	Package	Temperature Range	Packing
FAN4603MM18X	1.82V	6-Lead Molded Leadless Package (MLP), 4 x 2.5 x 1mm	-40 to 85°C	Tape and Reel
FAN4603MM15X	1.5V			
FAN4603MM13X	1.3V			
FAN4603MM12X	1.23V			
FAN4603MM10X	1.0V			

Note:

1. Other voltage options are available on request. Contact a Fairchild representative.

Typical Application

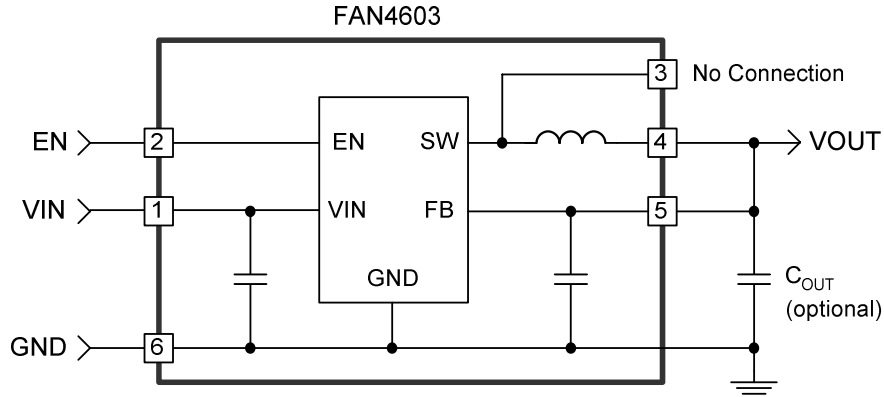

Figure 1. Typical Application

Pin Configuration

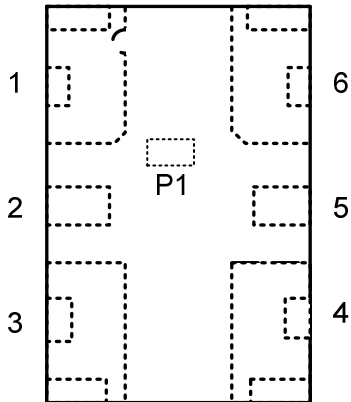

Figure 2. MLP 4.0 x 2.5 mm (Top View)

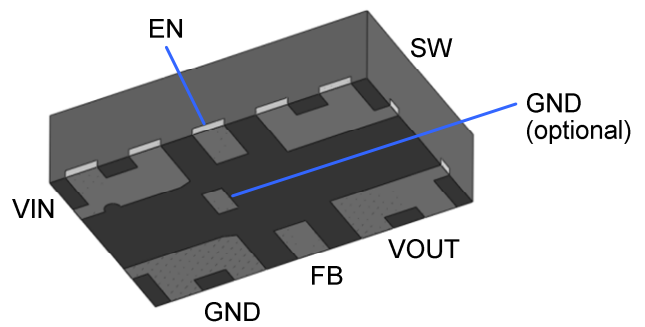

Figure 3. 3D Package View

Pin Definitions

Pin #	Name	Description
1	VIN	Input Voltage. Connect to input power source
2	EN	Enable. The device is in shutdown mode when voltage to this pin is <0.4V and enabled when >1.2V. Do not leave this pin floating.
3	SW	Switching Node. Leave this pin floating.
4	VOUT	Output Voltage. Connect to Load.
5	FB	Feedback/V_{OUT}. This pin must be shorted directly to VOUT (Pin 4).
6	GND	Ground. Power and IC ground. All signals are referenced to this pin.
P1	GND	Optional Ground Connection. Not typically used.

Absolute Maximum Ratings

Stresses exceeding the absolute maximum ratings may damage the device. The device may not function or be operable above the recommended operating conditions and stressing the parts to these levels is not recommended. In addition, extended exposure to stresses above the recommended operating conditions may affect device reliability. The absolute maximum ratings are stress ratings only.

Symbol	Parameter	Min.	Max.	Units
V_{IN}	Input Voltage with Respect to GND	-0.3	6.0	V
	Voltage on Any Other Pin with Respect to GND	-0.3	V_{IN}	V
T_J	Junction Temperature	-40	+150	°C
T_{STG}	Storage Temperature	-65	+150	°C
T_L	Lead Temperature (Soldering, 10 Seconds)		+260	°C
ESD	Electrostatic Discharge Capability	Human Body Model JESD22-A114	6	kV
		Charged Device Model, JESD22-C101	2	

Recommended Operating Conditions

The Recommended Operating Conditions table defines the conditions for actual device operation. Recommended operating conditions are specified to ensure optimal performance to the datasheet specifications. Fairchild does not recommend exceeding them or designing to Absolute Maximum Ratings.

Symbol	Parameter	Min.	Max.	Units
V_{CC}	Supply Voltage Range	2.3	5.5	V
I_{OUT}	Output Current	0	600	mA
T_A	Operating Ambient Temperature	-40	+85	°C
T_J	Operating Junction Temperature	-40	+125	°C

Thermal Properties

Symbol	Parameter	Typical	Units
Θ_{JA}	Junction-to-Ambient Thermal Resistance ⁽²⁾	120	°C/W

Note:

- Junction-to-ambient thermal resistance is a function of application and board layout. This data is measured with a two-layer 2s0p board in accordance to the JESD51- JEDEC standard. Special attention must be paid not to exceed junction temperature $T_{J(max)}$ at a given ambient temperature T_A .

Electrical Specifications

Unless otherwise noted, $V_{IN} = 2.5$ to $5.5V$, $EN = V_{IN}$. $T_A = -40^{\circ}C$ to $+85^{\circ}C$, using circuit of Figure 1. Typical values are at $3.6V_{IN}$, $T_A = 25^{\circ}C$.

Symbol	Parameter	Conditions	Min.	Typ.	Max.	Units			
Power Supplies									
I_Q	Quiescent Current			35	55	μA			
I_{SD}	Shutdown Supply Current	$V_{IN} = 3.6V$, $EN = GND$		0.1	2.0	μA			
V_{UVLO}	Under-Voltage Lockout Threshold	Rising V_{IN}		2.15	2.25	V			
V_{UVHYS}	Under-Voltage Lockout Hysteresis			150		mV			
V_{ENH}	Enable HIGH-Level Input Voltage		1.05			V			
V_{ENL}	Enable LOW-Level Input Voltage				0.4	V			
V_{EN_HYS}	Enable Logic Input Hysteresis			100		mV			
I_{EN}	Enable Input Leakage Current	$EN = V_{IN}$ or GND		0.01	1.00	μA			
Oscillator									
f_{OSC}	Oscillator Frequency ⁽³⁾	PWM Mode	5.4	6.0	6.6	MHz			
Regulation									
V_O	Output Voltage Accuracy	1.82V	$I_{LOAD} = 0$ to 600mA	1.784	1.820	1.890	V		
			PWM Mode	1.784	1.820	1.856			
		1.50V	$I_{LOAD} = 0$ to 600mA	1.470	1.500	1.560			
			PWM Mode	1.470	1.500	1.530			
		1.30V	$I_{LOAD} = 0$ to 600mA	1.274	1.300	1.352			
			PWM Mode	1.274	1.300	1.326			
		1.23V	$I_{LOAD} = 0$ to 600mA	1.207	1.233	1.283			
			PWM Mode	1.207	1.233	1.260			
		1.00V	$I_{LOAD} = 0$ to 600mA	0.975	1.000	1.050			
			PWM Mode	0.975	1.000	1.025			
		t_{SS}	Soft-Start Time	Rising EN to V_{OUT} Regulation		180		300	μs
		Protection							
I_{LIM}	Peak Input Current Limit		850	1050	1250	mA			
T_{TSD}	Thermal Shutdown			+150		$^{\circ}C$			
T_{HYS}	Thermal Shutdown Hysteresis			+15		$^{\circ}C$			

Note:

- PWM frequency may be lower than specified when limited by t_{ON_min} (minimum on-time) or t_{OFF_min} (minimum off-time), at duty cycle extremes, but output regulation is maintained.

Typical Performance

Unless otherwise specified, $V_{IN} = 3.7V$, $T_A = 25^\circ C$, $V_{IN} = V_{EN}$

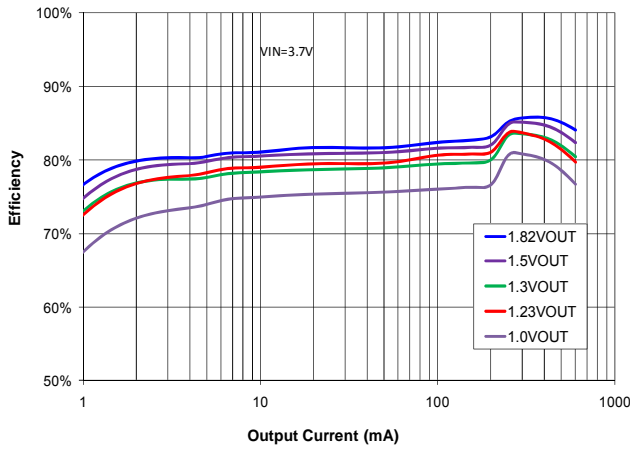

Figure 4. Efficiency, $V_{IN} = 3.7V$

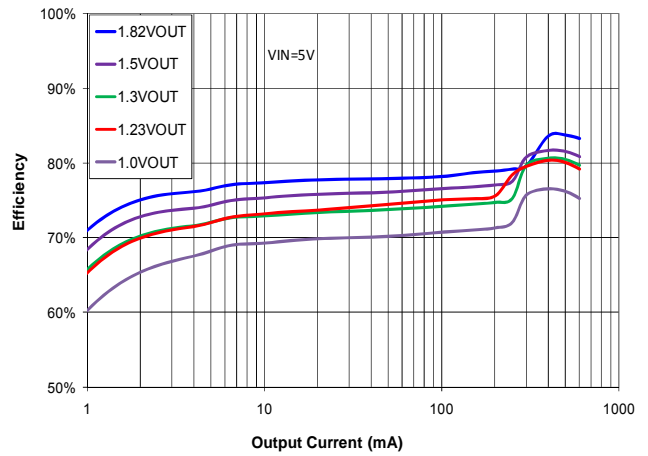

Figure 5. Efficiency, $V_{IN} = 5V$

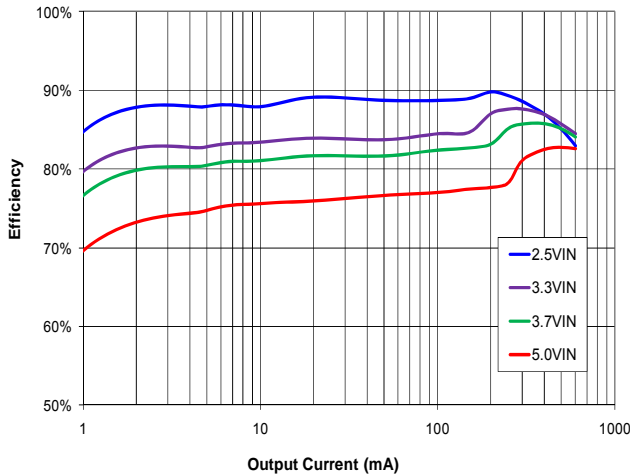

Figure 6. 1.82V_{OUT} Efficiency

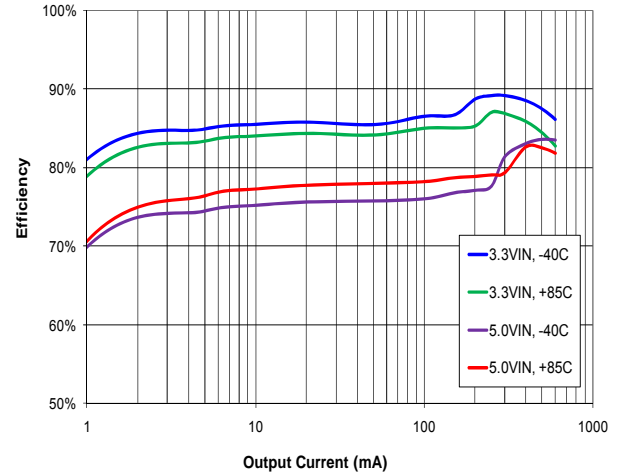

Figure 7. 1.82 V_{OUT} Efficiency Over Temperature

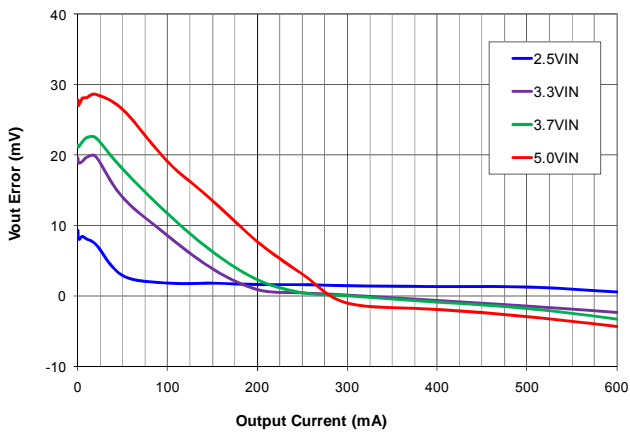

Figure 8. 1.82V_{OUT} Regulation (Normalized)

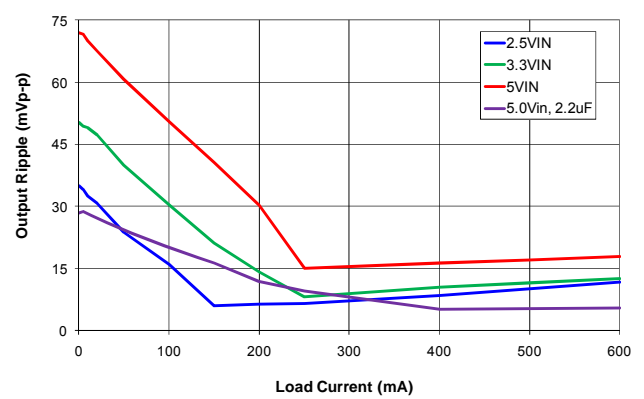

Figure 9. 1.82V_{OUT} Output Ripple with Optional 2.2 μF C_{OUT} (1.5 μF Actual)

Typical Performance

Unless otherwise specified, $V_{IN} = 3.7V$, $T_A = 25^\circ C$, $V_{IN} = V_{EN}$

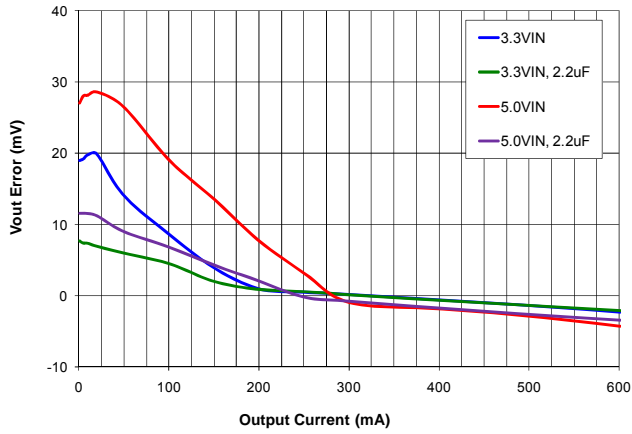

Figure 10. 1.82V_{OUT} Regulation (Normalized) with Optional 2.2µF C_{OUT} (1.5µF Actual)

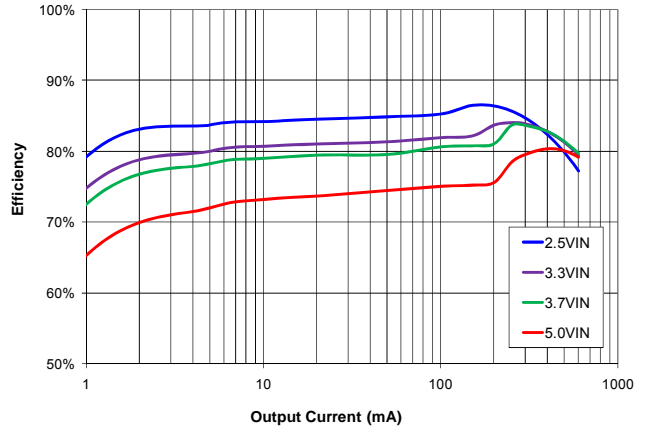

Figure 11. 1.23 V_{OUT} Efficiency

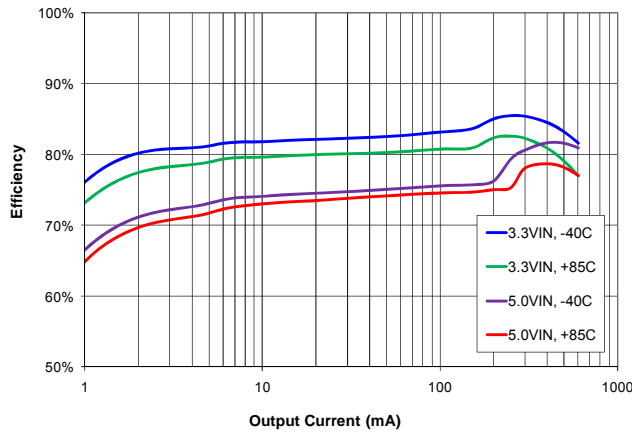

Figure 12. 1.23V_{OUT} Efficiency Over Temperature

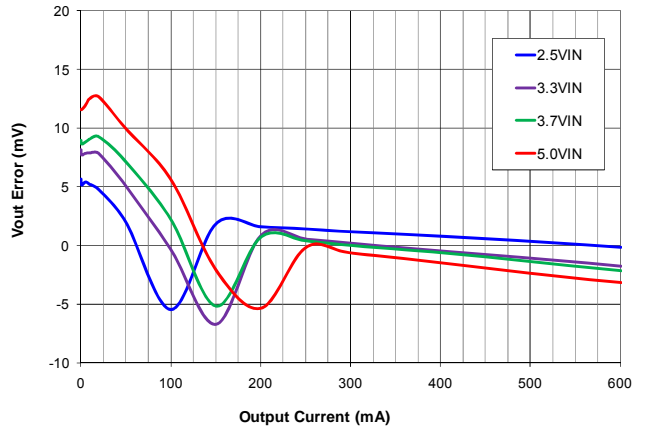

Figure 13. 1.23V_{OUT} Regulation (Normalized)

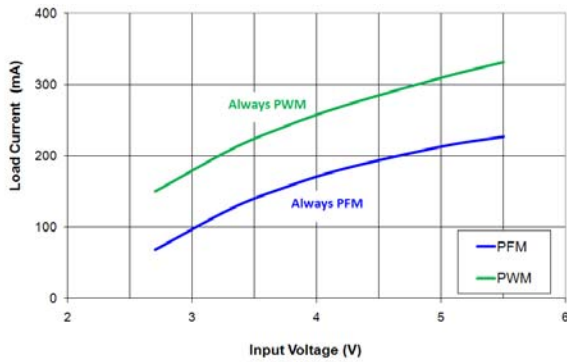

Figure 14. 1.82V_{OUT} PFM / PWM Boundary

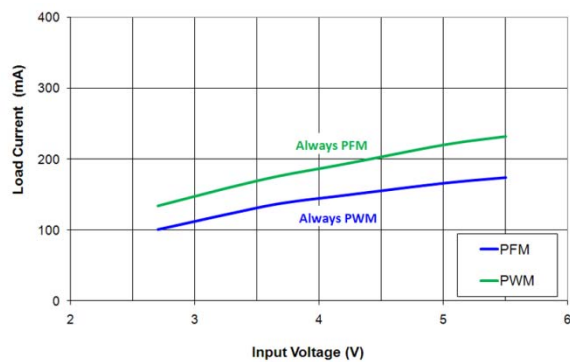

Figure 15. 1.23V_{OUT} PFM / PWM Boundary

Typical Performance

Unless otherwise specified, $V_{IN} = 3.7V$, $T_A = 25^\circ C$, $V_{IN} = V_{EN}$

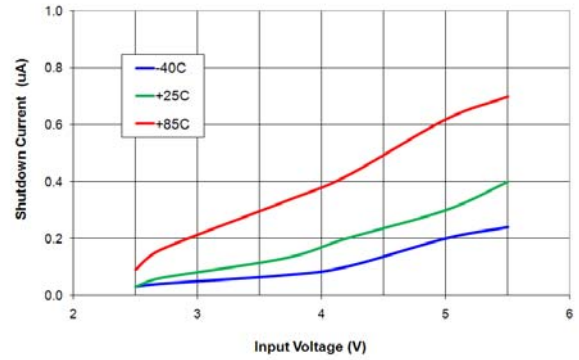
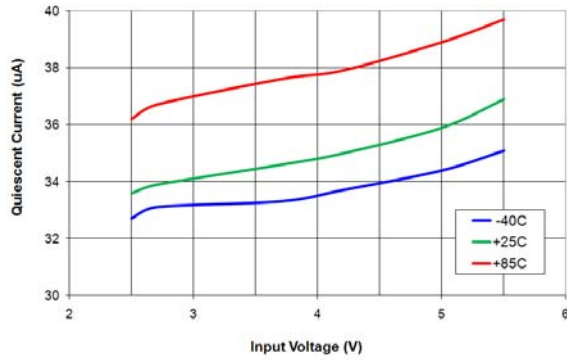

Figure 16. Quiescent Current Over Temperature ($EN=V_{IN}$) Figure 17. Shutdown Current Over Temperature ($EN=0V$)

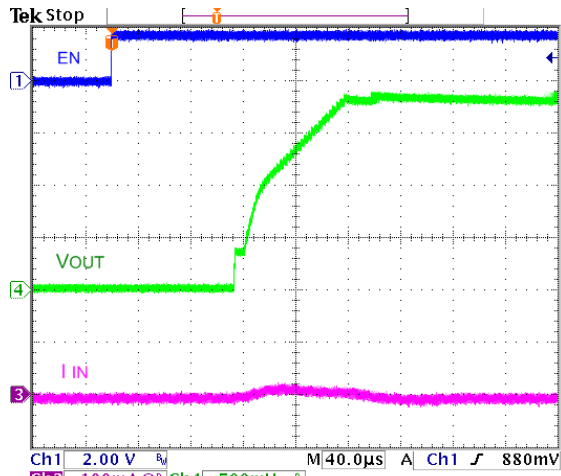

Figure 18. 1.82V_{OUT} Startup, 3.7V_{IN}, No Load

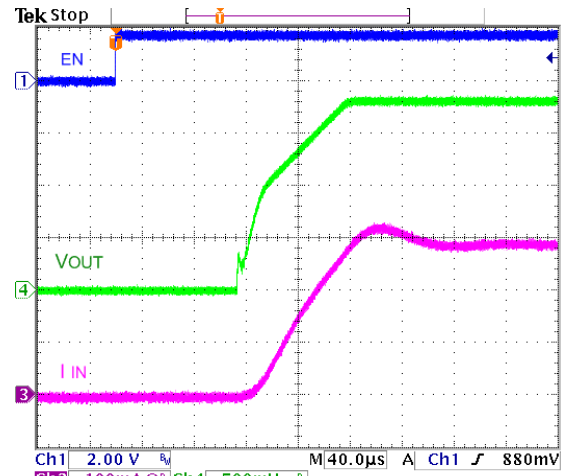

Figure 19. 1.82V_{OUT} Startup, 3.7V_{IN}, 3.6Ω Load

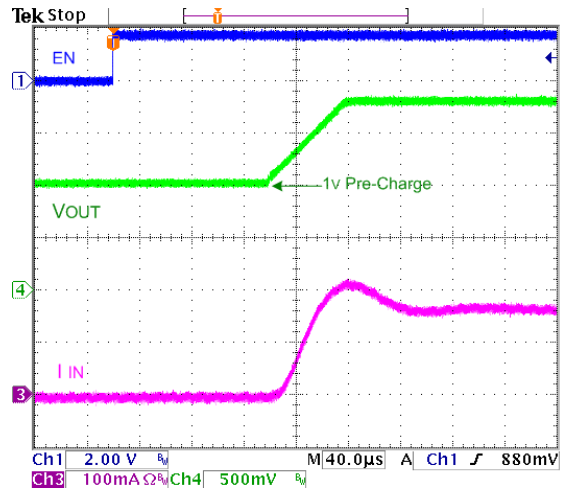

Figure 20. 1.82V_{OUT} Startup into Pre-Charged Output, 3.7V_{IN}, 300mA Load

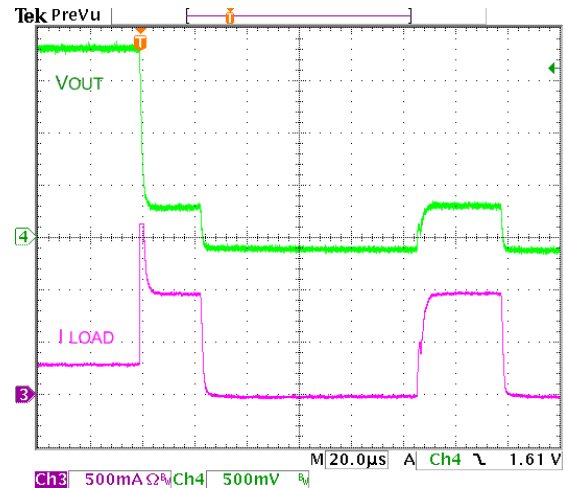

Figure 21. Over-Current Protection, 300mA Load Transition to 300mΩ Fault

Typical Performance

Unless otherwise specified, $V_{IN} = 3.7V$, $T_A = 25^\circ C$, $V_{IN} = V_{EN}$

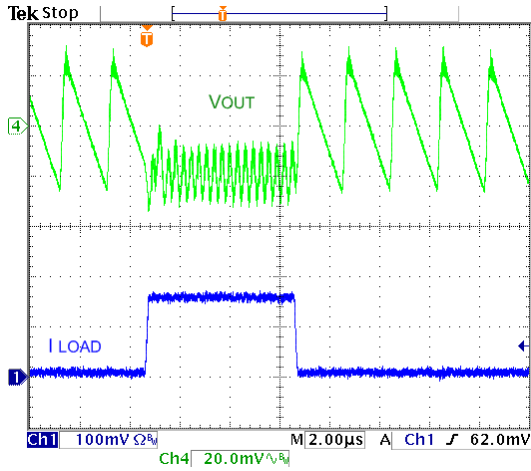

Figure 22. 1.82V_{OUT} Load Transient, 10-160mA, $t_R/t_F=100ns$

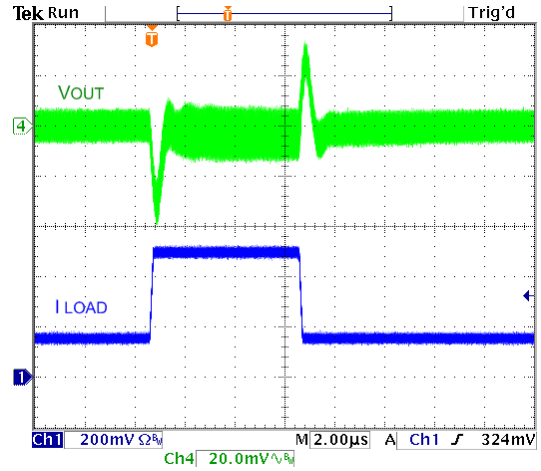

Figure 23. 1.82V_{OUT} Load Transient, 150-500mA, $t_R/t_F=100ns$

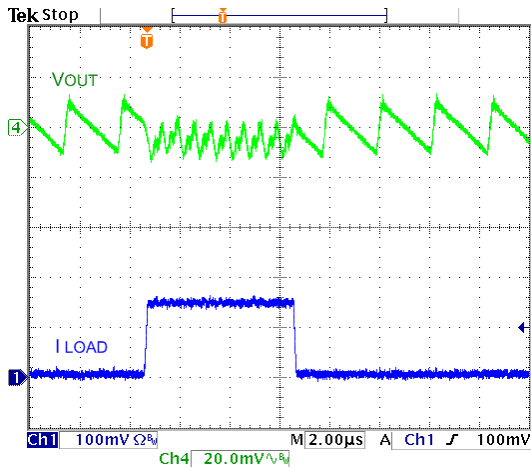

Figure 24. 1.82V_{OUT} Load Transient, 10-160mA, $t_R/t_F=100ns$ with Optional 2.2µF C_{OUT}

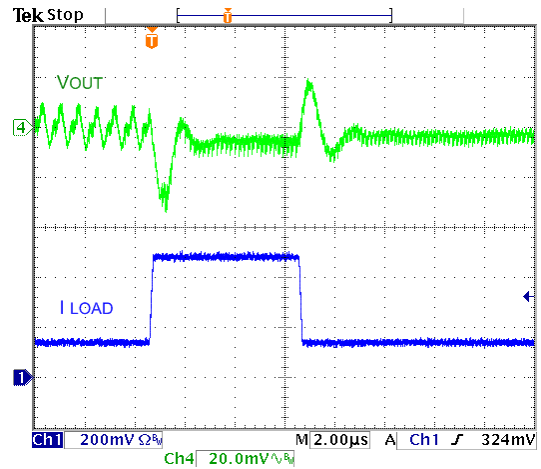

Figure 25. 1.82V_{OUT} Load Transient, 150-500mA, $t_R/t_F=100ns$ with Optional 2.2µF C_{OUT}

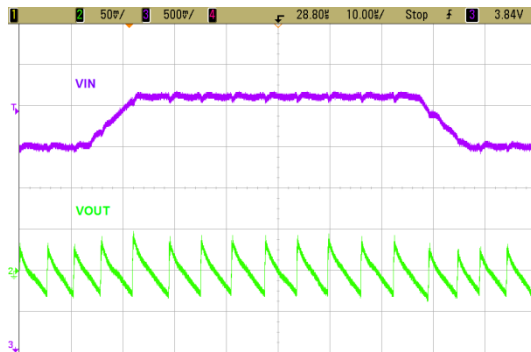

Figure 26. 1.82V_{OUT} Line Transient, 3.6-4.2V_{IN}, $t_R/t_F=10µs$, with 10mA Load

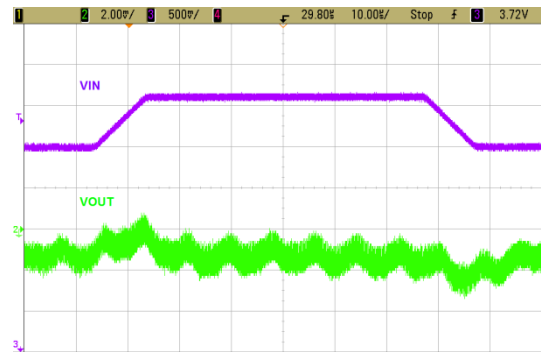

Figure 27. 1.82V_{OUT} Line Transient, 3.6-4.2V_{IN}, $t_R/t_F=10µs$, with 300mA Load

Operation Description

The FAN4603 is a 600mA, step-down, switching-voltage regulator that delivers a fixed output from an input voltage supply of 2.3V to 5.5V. Using a proprietary architecture with synchronous rectification, the FAN4603 is capable of delivering a peak efficiency of >90%, while maintaining efficiency over 80% at load currents as low as 1mA. The regulator operates at a nominal PWM frequency of 6MHz.

Control Scheme

The FAN4603 uses a proprietary, non-linear, fixed-frequency PWM modulator to deliver a fast load transient response, while maintaining a constant switching frequency over a wide range of operating conditions. Regulator stability is not dependent on output capacitor ESR, which allows the use of ceramic capacitors. Although this type of operation normally results in a switching frequency that varies with input voltage and load current, an internal frequency loop holds the switching frequency constant over a large range of input voltages and load currents.

For very light loads, FAN4603 incorporates a discontinuous current (DCM) single-pulse PFM mode, which produces lower output ripple when compared with other PFM architectures. Transition between PWM and PFM is seamless, with a glitch of less than 20mV at V_{OUT} during the transition between DCM and CCM modes.

Combined with exceptional transient response characteristics, the very low quiescent current of the controller (35 μ A) maintains high efficiency; even at very light loads, while preserving fast transient response for applications requiring tight output regulation.

Enable and Soft-Start

When EN is LOW, all circuits in FAN4603 are off and the IC draws ~100nA of current. When EN is HIGH and V_{IN} is above its UVLO threshold, the regulator begins a soft-start cycle. The output ramp during soft-start is a fixed slew rate of 50mV/ μ s from 0 to 1 V_{OUT} , then 12.5mV/ μ s until the output reaches its setpoint.

PWM mode operation is prohibited during the soft-start cycle to prevent C_{OUT} from being discharged. This allows glitchless starting into a pre-charged output.

Startup into Large C_{OUT}

The IC may fail to start if heavy load is applied during startup and a large external C_{OUT} is present. This is due to the current-limit fault response, which protects the IC in an over-current condition during soft-start.

The current required to charge C_{OUT} during soft-start, referred to as “displacement current,” is given as:

$$I_{DISP} = C_{OUT} \cdot \frac{dV}{dt} \quad (1)$$

where $\frac{dV}{dt}$ refers to the soft-start slew rate.

To prevent shutdown during soft-start, the following condition must be met:

$$I_{DISP} + I_{LOAD} < I_{MAX(DC)} \quad (2)$$

where $I_{MAX(DC)}$ is the maximum load current the IC is guaranteed to support (600mA).

Table 1 shows combinations of external C_{OUT} that allow the IC to start successfully with the minimum R_{LOAD} that can be supported at each.

Table 1. Minimum R_{LOAD} Values for Soft-Start with Various External C_{OUT} Values

C_{OUT}	Minimum R_{LOAD}
2.2 μ F, 0402	$V_{OUT} / 0.55$
4.7 μ F, 0402	$V_{OUT} / 0.50$
10 μ F, 0603	$V_{OUT} / 0.45$

Multiple soft-start cycles may be required for $C_{OUT} > 10\mu$ f (15 μ f with no load). The IC shuts down for 85 μ s when $I_{DISP} + I_{LOAD}$ exceeds I_{LIMIT} for more than 21 μ s of current limit. The IC then begins a new soft-start cycle. Subsequent soft-start cycles begin with any charge retained by C_{OUT} while the IC is off, allowing V_{OUT} to incrementally reach regulation over multiple soft-start attempts.

Current Limit, Fault Shutdown, and Restart

A heavy load or short circuit on the output causes the current to increase until a maximum current threshold is reached. Upon reaching this point, the high-side switch turns off, preventing high currents from causing damage. The regulator continues to limit the current cycle-by-cycle. After 21 μ s of current limit, the regulator triggers an over-current fault, causing the regulator to shut down for about 85 μ s before attempting an automatic restart.

If the fault is caused by short circuit, the soft-start circuit attempts to restart and produces an over-current fault after about 32 μ s, which results in a duty cycle of less than 30%, limiting power dissipation.

Under-Voltage Lockout (UVLO)

When EN is HIGH, the under-voltage lockout keeps the part from operating until the input supply voltage rises high enough to properly operate. This ensures no misbehavior of the regulator during startup or shutdown.

Thermal Shutdown

When the die temperature increases, due to a high load condition and/or a high ambient temperature, the output switching is disabled until the temperature on the die has fallen sufficiently. The junction temperature at which the thermal shutdown activates is nominally 150°C with 15°C hysteresis. After cooling, the IC automatically restarts, with a soft-start cycle.

Reducing PFM Output Ripple

PFM output ripple amplitude can be reduced by adding external C_{OUT} , with negligible impact on efficiency.

Reduced output ripple also results in less DC voltage excursion at very light loads. Maximum PFM ripple occurs at no load and is V_{IN} and V_{OUT} proportional.

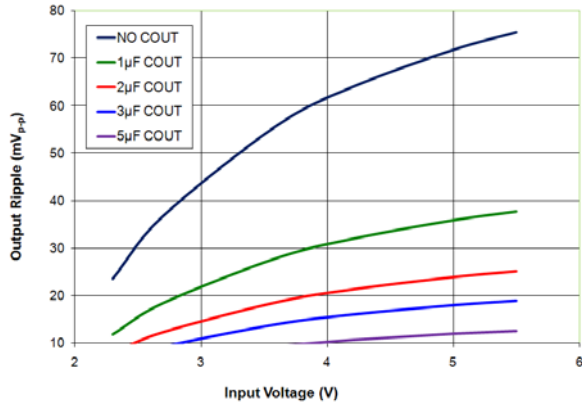

Figure 28. Typical 1.82V_{OUT} No Load PFM Ripple vs. V_{IN}

Note:

- Ripple is less for lower V_{OUT} levels.

The effective value of external C_{OUT} for a desired ripple amplitude can be determined using:

$$C_{OUT}(\mu F) = \left(\frac{(V_{IN} - V_{OUT}) \cdot V_{OUT} \cdot 62}{V_{IN} \cdot V_R} \right) - 1 \quad (3)$$

where V_R is the desired output ripple amplitude in mV and V_{IN} and V_{OUT} are in Volts.

The simplified equation above is representative of nominal component values and does not account for device tolerances. The bias level effects associated with case size, voltage rating, and dielectric type of ceramic capacitors should be considered when selecting C_{OUT} .

Minimum Off-Time Effect on Switching Frequency

$t_{OFF(MIN)}$ is 50ns, while $t_{ON(MIN)}$ is 35nS This imposes constraints on the maximum/minimum $\frac{V_{OUT}}{V_{IN}}$ that the

FAN4603 can provide while maintaining a fixed switching frequency in PWM mode.

When V_{IN} is LOW, fixed switching is maintained as long as

$$\frac{V_{OUT}}{V_{IN}} \leq 1 - t_{OFF(MIN)} \cdot f_{SW} \approx 0.7 .$$

When V_{IN} is HIGH, fixed switching is maintained as long as

$$\frac{V_{OUT}}{V_{IN}} \geq t_{ON(MIN)} \cdot f_{SW} \approx 0.2$$

The switching frequency drops when the regulator cannot provide sufficient duty cycle at 6MHz to maintain regulation. Lowering the switching frequency allows V_{OUT} to remain in regulation, even at very low or very high duty cycle.

PCB Layout Guideline

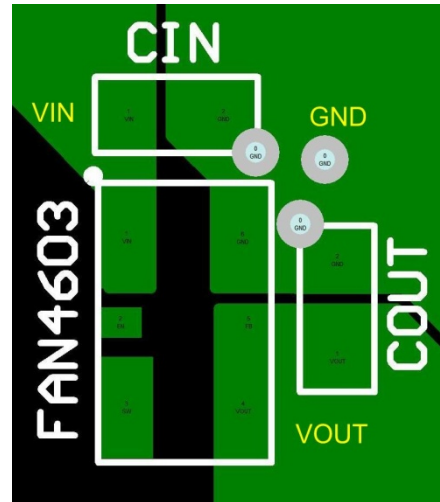

Figure 29. Recommended PCB Layout

FB (pin 5) must be directly connected to VOUT (pin 4).

Figure 29 shows the recommended locations of optional C_{IN} and C_{OUT} , shown as 0603 size devices.

Pad P1, shown in Figure 30 “Land Pattern,” is an optional GND pin. Connection is not required on the PCB.

Physical Dimensions

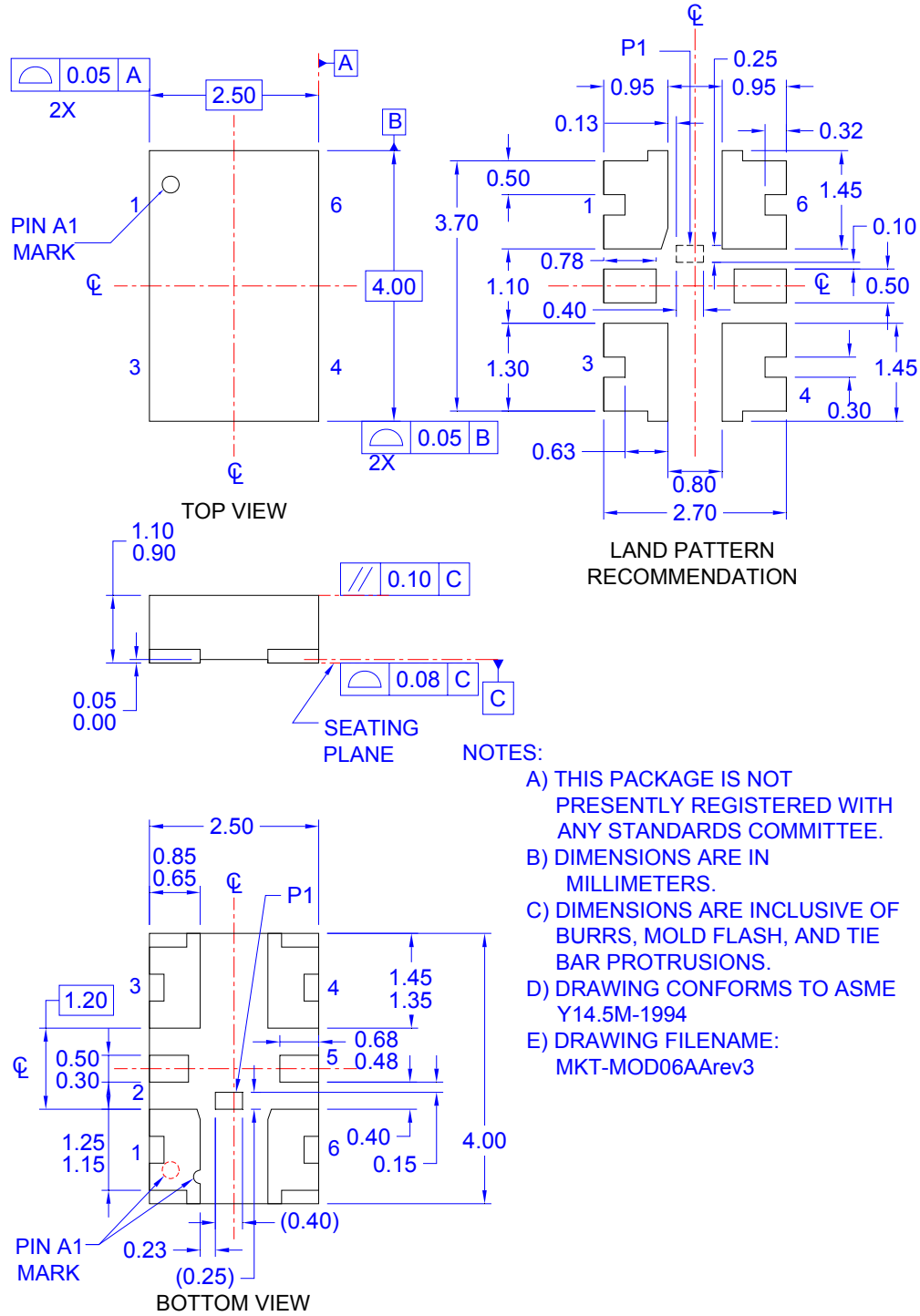

Figure 30.6-Lead, MicroModule QFN 2.5 x 4 x 1mm

Package drawings are provided as a service to customers considering Fairchild components. Drawings may change in any manner without notice. Please note the revision and/or date on the drawing and contact a Fairchild Semiconductor representative to verify or obtain the most recent revision. Package specifications do not expand the terms of Fairchild's worldwide terms and conditions, specifically the warranty therein, which covers Fairchild products.

Always visit Fairchild Semiconductor's online packaging area for the most recent package drawings:
<http://www.fairchildsemi.com/packaging/>.



TRADEMARKS

The following includes registered and unregistered trademarks and service marks, owned by Fairchild Semiconductor and/or its global subsidiaries, and is not intended to be an exhaustive list of all such trademarks.

AccuPower™
 Auto-SPM™
 Build it Now™
 CorePLUS™
 CorePOWER™
 CROSSVOLT™
 CTL™
 Current Transfer Logic™
 DEUXPEED®
 Dual Cool™
 EcoSPARK®
 EfficientMax™
 ESBC™

 Fairchild®
 Fairchild Semiconductor®
 FACT Quiet Series™
 FACT®
 FAST®
 FastvCore™
 FETBench™
 FlashWriter®
 FPS™
 F-PFST™
 FRFET®
 Global Power Resource™
 Green FPS™
 Green FPS™ e-Series™
 Gmax™
 GTO™
 IntelliMAX™
 ISOPLANAR™
 MegaBuck™
 MICROCOUPLER™
 MicroFET™
 MicroPak™
 MicroPak2™
 MillerDrive™
 MotionMax™
 Motion-SPM™
 OptoHIT™
 OPTOLOGIC®
 OPTOPLANAR®

 PDP SPM™

Power-SPM™
 PowerTrench®
 PowerXS™
 Programmable Active Droop™
 QFET®
 QST™
 Quiet Series™
 RapidConfigure™

 Saving our world, 1mW/W/kW at a time™
 SignalVise™
 SmartMax™
 SMART START™
 SPM®
 STEALTH™
 SuperFET™
 SuperSOT™-3
 SuperSOT™-6
 SuperSOT™-8
 SupreMOS®
 SyncFET™
 Sync-Lock™

 SYSTEM GENERAL®
 The Power Franchise®

 TinyBoost™
 TinyBuck™
 TinyCalc™
 TinyLogic®
 TINYOPTO™
 TinyPower™
 TinyPWM™
 TinyWire™
 TriFault Detect™
 TRUECURRENT™
 μSerDes™
 SerDes®
 UHC®
 Ultra FRFET™
 UniFET™
 VCX™
 VisualMax™
 XS™

* Trademarks of System General Corporation, used under license by Fairchild Semiconductor.

DISCLAIMER

FAIRCHILD SEMICONDUCTOR RESERVES THE RIGHT TO MAKE CHANGES WITHOUT FURTHER NOTICE TO ANY PRODUCTS HEREIN TO IMPROVE RELIABILITY, FUNCTION, OR DESIGN. FAIRCHILD DOES NOT ASSUME ANY LIABILITY ARISING OUT OF THE APPLICATION OR USE OF ANY PRODUCT OR CIRCUIT DESCRIBED HEREIN; NEITHER DOES IT CONVEY ANY LICENSE UNDER ITS PATENT RIGHTS, NOR THE RIGHTS OF OTHERS. THESE SPECIFICATIONS DO NOT EXPAND THE TERMS OF FAIRCHILD'S WORLDWIDE TERMS AND CONDITIONS, SPECIFICALLY THE WARRANTY THEREIN, WHICH COVERS THESE PRODUCTS.

LIFE SUPPORT POLICY

FAIRCHILD'S PRODUCTS ARE NOT AUTHORIZED FOR USE AS CRITICAL COMPONENTS IN LIFE SUPPORT DEVICES OR SYSTEMS WITHOUT THE EXPRESS WRITTEN APPROVAL OF FAIRCHILD SEMICONDUCTOR CORPORATION.

As used herein:

1. Life support devices or systems are devices or systems which, (a) are intended for surgical implant into the body or (b) support or sustain life, and (c) whose failure to perform when properly used in accordance with instructions for use provided in the labeling, can be reasonably expected to result in a significant injury of the user.
2. A critical component in any component of a life support, device, or system whose failure to perform can be reasonably expected to cause the failure of the life support device or system, or to affect its safety or effectiveness.

ANTI-COUNTERFEITING POLICY

Fairchild Semiconductor Corporation's Anti-Counterfeiting Policy. Fairchild's Anti-Counterfeiting Policy is also stated on our external website, www.fairchildsemi.com, under Sales Support.

Counterfeiting of semiconductor parts is a growing problem in the industry. All manufacturers of semiconductor products are experiencing counterfeiting of their parts. Customers who inadvertently purchase counterfeit parts experience many problems such as loss of brand reputation, substandard performance, failed applications, and increased cost of production and manufacturing delays. Fairchild is taking strong measures to protect ourselves and our customers from the proliferation of counterfeit parts. Fairchild strongly encourages customers to purchase Fairchild parts either directly from Fairchild or from Authorized Fairchild Distributors who are listed by country on our web page cited above. Products customers buy either from Fairchild directly or from Authorized Fairchild Distributors are genuine parts, have full traceability, meet Fairchild's quality standards for handling and storage and provide access to Fairchild's full range of up-to-date technical and product information. Fairchild and our Authorized Distributors will stand behind all warranties and will appropriately address any warranty issues that may arise. Fairchild will not provide any warranty coverage or other assistance for parts bought from Unauthorized Sources. Fairchild is committed to combat this global problem and encourage our customers to do their part in stopping this practice by buying direct or from authorized distributors.

PRODUCT STATUS DEFINITIONS

Definition of Terms

Datasheet Identification	Product Status	Definition
Advance Information	Formative / In Design	Datasheet contains the design specifications for product development. Specifications may change in any manner without notice.
Preliminary	First Production	Datasheet contains preliminary data; supplementary data will be published at a later date. Fairchild Semiconductor reserves the right to make changes at any time without notice to improve design.
No Identification Needed	Full Production	Datasheet contains final specifications. Fairchild Semiconductor reserves the right to make changes at any time without notice to improve the design.
Obsolete	Not In Production	Datasheet contains specifications on a product that is discontinued by Fairchild Semiconductor. The datasheet is for reference information only.

Rev. 149

ON Semiconductor and  are trademarks of Semiconductor Components Industries, LLC dba ON Semiconductor or its subsidiaries in the United States and/or other countries. ON Semiconductor owns the rights to a number of patents, trademarks, copyrights, trade secrets, and other intellectual property. A listing of ON Semiconductor's product/patent coverage may be accessed at www.onsemi.com/site/pdf/Patent-Marking.pdf. ON Semiconductor reserves the right to make changes without further notice to any products herein. ON Semiconductor makes no warranty, representation or guarantee regarding the suitability of its products for any particular purpose, nor does ON Semiconductor assume any liability arising out of the application or use of any product or circuit, and specifically disclaims any and all liability, including without limitation special, consequential or incidental damages. Buyer is responsible for its products and applications using ON Semiconductor products, including compliance with all laws, regulations and safety requirements or standards, regardless of any support or applications information provided by ON Semiconductor. "Typical" parameters which may be provided in ON Semiconductor data sheets and/or specifications can and do vary in different applications and actual performance may vary over time. All operating parameters, including "Typicals" must be validated for each customer application by customer's technical experts. ON Semiconductor does not convey any license under its patent rights nor the rights of others. ON Semiconductor products are not designed, intended, or authorized for use as a critical component in life support systems or any FDA Class 3 medical devices or medical devices with a same or similar classification in a foreign jurisdiction or any devices intended for implantation in the human body. Should Buyer purchase or use ON Semiconductor products for any such unintended or unauthorized application, Buyer shall indemnify and hold ON Semiconductor and its officers, employees, subsidiaries, affiliates, and distributors harmless against all claims, costs, damages, and expenses, and reasonable attorney fees arising out of, directly or indirectly, any claim of personal injury or death associated with such unintended or unauthorized use, even if such claim alleges that ON Semiconductor was negligent regarding the design or manufacture of the part. ON Semiconductor is an Equal Opportunity/Affirmative Action Employer. This literature is subject to all applicable copyright laws and is not for resale in any manner.

PUBLICATION ORDERING INFORMATION

LITERATURE FULFILLMENT:

Literature Distribution Center for ON Semiconductor
19521 E. 32nd Pkwy, Aurora, Colorado 80011 USA
Phone: 303-675-2175 or 800-344-3860 Toll Free USA/Canada
Fax: 303-675-2176 or 800-344-3867 Toll Free USA/Canada
Email: orderlit@onsemi.com

N. American Technical Support: 800-282-9855 Toll Free
USA/Canada
Europe, Middle East and Africa Technical Support:
Phone: 421 33 790 2910
Japan Customer Focus Center
Phone: 81-3-5817-1050

ON Semiconductor Website: www.onsemi.com
Order Literature: <http://www.onsemi.com/orderlit>
For additional information, please contact your local
Sales Representative