



**TV-4 rated.  
2 Form A 3A/5A  
power relays**

LA RELAYS (ALA)



RoHS compliant

Protective construction: Flux-resistant type

### FEATURES

- 1. 2 Form A slim type**  
24(L) × 12(W) × 25(H) mm  
.945(L)×.472(W)×.984(H) inch
- 2. 3A type and 5A TV type**  
3A type: Contact reliability and break performance best suited for protecting and switching speakers.  
5A TV type: Tough against inrush current and optimal for turning on and off the power supply. Rated TV-4 (UL, CSA).
- 3. Long insulation distance**
  - Creepage distance and clearances between contact and coil: Min. 6 mm .236 inch (In compliance with IEC65)
  - Surge withstand voltage between contact and coil: 10,000 V

- 4. High noise immunity realized by the card separation structure between contact and coil**
- 5. Conforms to the various safety standards**
  - UL, CSA, VDE, TÜV, SEMKO approved

### TYPICAL APPLICATIONS

- Audio devices
- Monitor
- Automatic vending machine

### ORDERING INFORMATION

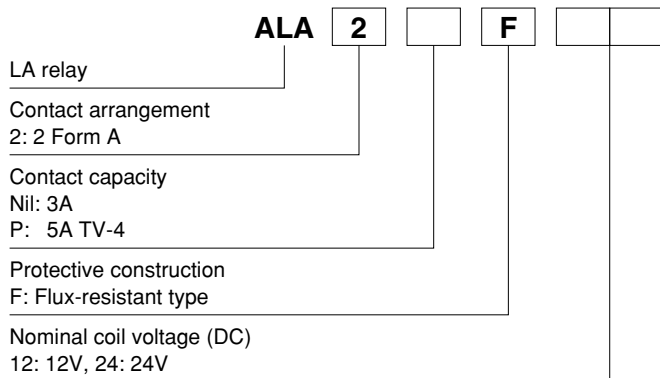

Note: Certified by UL, CSA, VDE, TÜV, SEMKO and TV-4

### TYPES

Contact arrangement	Coil voltage	Part No.	
		3A type	5A TV type (TV-4)
2 Form A	12V DC	ALA2F12	ALA2PF12
	24V DC	ALA2F24	ALA2PF24

Standard packing Carton: 100 pcs. Case: 500 pcs.  
Note: 4.5V, 5V, 6V, 9V and 18V DC types are also available. Please consult us for details.

# RATING

## 1. Coil data

Nominal coil voltage	Pick-up voltage (at 20°C 68°F)	Drop-out voltage (at 20°C 68°F)	Nominal operating current [±10%] (at 20°C 68°F)	Coil resistance [±10%] (at 20°C 68°F)	Nominal operating power	Max. applied voltage (at 20°C 68°F)
12V DC	75%V or less of nominal voltage (Initial)	5%V or more of nominal voltage (Initial)	44.2mA	272Ω	530mW	15.6V DC
24V DC			22.1mA	1,087Ω		31.2V DC

## 2. Specifications

Characteristics	Item	Specifications	
		3A type	5A TV type (TV-4)
Contact	Arrangement	2 Form A	
	Contact resistance (Initial)	Max. 50 mΩ (By voltage drop 6V DC 1A)	Max. 100 mΩ (By voltage drop 6V DC 1A)
	Contact material	Gold-clad, AgNi type	AgSnO <sub>2</sub> type
Rating	Nominal switching capacity (resistive load)	3A 125V AC	5A 277V AC
	Max. switching power (resistive load)	625VA	1,385VA
	Max. switching voltage	125V AC	277V AC
	Max. switching current	5A (AC)	
	Min. switching capacity (reference value)*1	100mA 5V DC	
Electrical characteristics	Insulation resistance (Initial)	Min. 1,000MΩ (at 500V DC) Measurement at same location as "Breakdown voltage" section.	
	Breakdown voltage (Initial)	Between contact sets	1,000 Vrms for 1 min. (Detection current: 10 mA)
		Between open contacts	1,000 Vrms for 1 min. (Detection current: 10 mA)
		Between contact and coil	4,000 Vrms for 1 min. (Detection current: 10 mA)
	Surge breakdown voltage*2 (Between contact and coil) (Initial)	10,000 V	
	Operate time (at nominal voltage) (at 20°C 68°F) (Initial)	Max. 15 ms (excluding contact bounce time.)	
Release time (at nominal voltage) (at 20°C 68°F) (Initial)	Max. 15 ms (excluding contact bounce time) (With diode)		
Mechanical characteristics	Shock resistance	Functional	200 m/s <sup>2</sup> (Half-wave pulse of sine wave: 11 ms; detection time: 10μs.)
		Destructive	1,000 m/s <sup>2</sup> (Half-wave pulse of sine wave: 6 ms.)
	Vibration resistance	Functional	10 to 55 Hz at double amplitude of 1.5 mm (Detection time: 10μs.)
		Destructive	10 to 55 Hz at double amplitude of 1.5 mm
Expected life	Mechanical	Min. 10 <sup>6</sup> (at 180 times/min.)	
	Electrical (at 20 times/min.)	Min. 5×10 <sup>4</sup> (ON: OFF=1.5s: 1.5s) (at nominal switching capacity)	
Conditions	Conditions for operation, transport and storage*3	Ambient temperature: -40°C to +70°C -40°F to +158°F, Humidity: 5 to 85% R.H. (Not freezing and condensing at low temperature), Air pressure: 86 to 106kPa	
	Max. operating speed	20 times/min. (at nominal switching capacity)	
Unit weight		Approx. 13 g .46 oz	

Notes: \*1. This value can change due to the switching frequency, environmental conditions, and desired reliability level, therefore it is recommended to check this with the actual load.

\*2. Wave is standard shock voltage of ±1.2×50μs according to JEC-212-1981

\*3. The upper limit of the ambient temperature is the maximum temperature that can satisfy the coil temperature rise value. Refer to Usage, transport and storage conditions in NOTES.

## REFERENCE DATA

1. Max. switching power (AC resistive load)

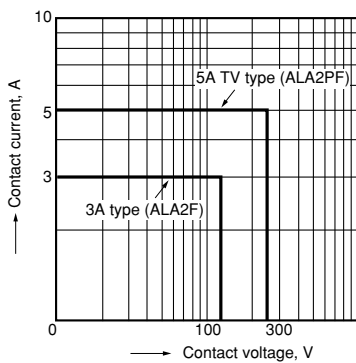

2-(1). Life curve (250 V AC resistive load) 3A type (ALA2F)

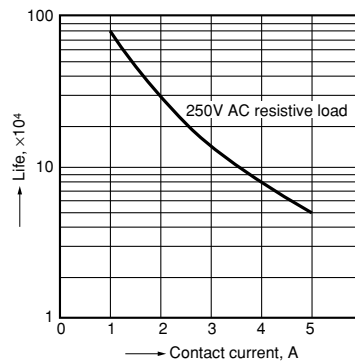

2-(2). Life curve (125 V AC resistive load) 5A TV type (ALA2PF)

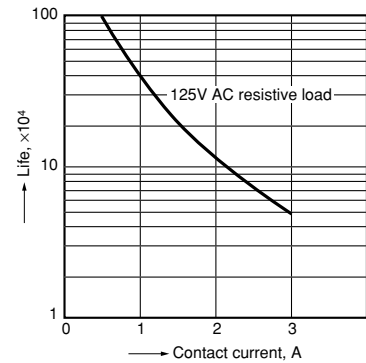

3-(1). Coil temperature rise

Sample: ALA2F12, 6 pcs.  
Measured portion: coil inside  
Contact current: 0 A, 3A

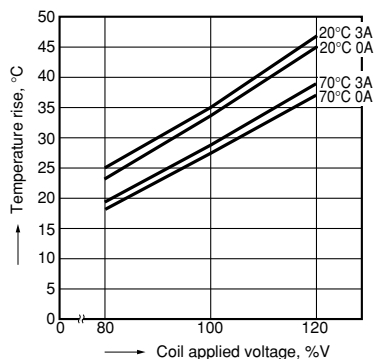

3-(2). Coil temperature rise

Sample: ALA2PF12, 6 pcs.  
Measured portion: coil inside  
Contact current: 0 A, 5A

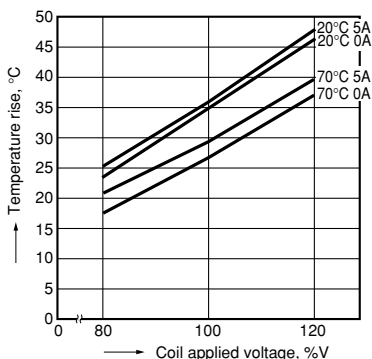

4. Ambient temperature characteristics and coil applied voltage

Contact current: ALA2F=3A  
ALA2PF=5A

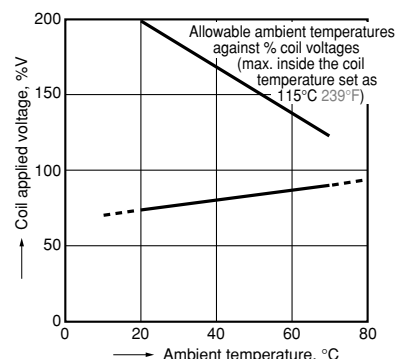

5-(1). Electrical life test

(3 A 125 V AC, resistive load)

Sample: ALA2F12, 6 pcs.  
Operation frequency: 20 times/min.  
(ON/OFF = 1.5s: 1.5s)  
Ambient temperature: 20°C 68°F

Circuit:

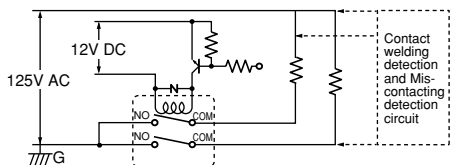

Change of pick-up and drop-out voltage

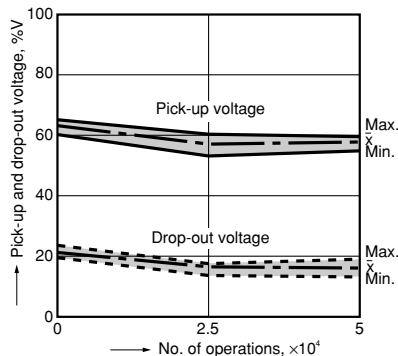

Change of contact resistance

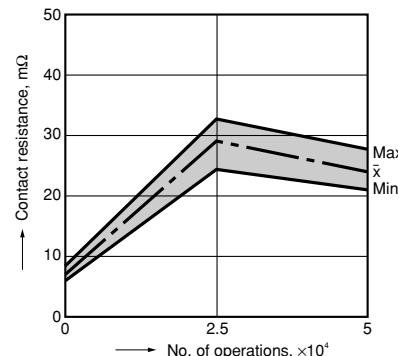

5-(2). Electrical life test

(5 A 250 V AC, resistive load)

Sample: ALA2PF12, 6 pcs.  
Operation frequency: 20 times/min.  
(ON/OFF = 1.5s: 1.5s)  
Ambient temperature: 20°C 68°F

Circuit:

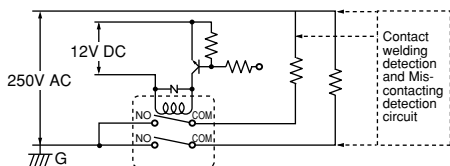

Change of pick-up and drop-out voltage

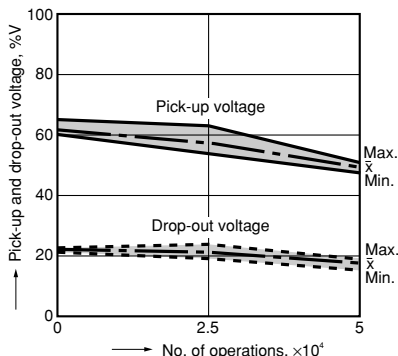

Change of contact resistance

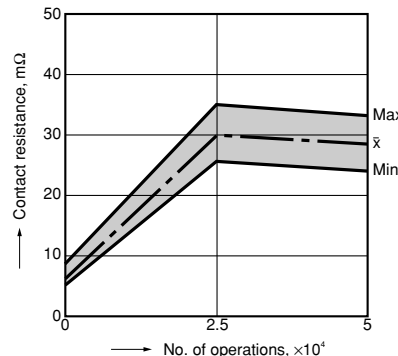

5-(3). Electrical life test

(UL lamp load test TV-4)

Tested sample: ALA2PF12, 6 pcs.

- Overload test  
Load: 6.0 A 120 V AC (60 Hz),  
Inrush: 91 A  
Operation frequency: 10 times/min  
(ON: OFF = 1 s: 5 s)  
No. of operations: 50 ope.
- Endurance test  
Load: 4A 120 V AC (60 Hz),  
Inrush: 65 A  
Operation frequency: 10 times/min  
(ON: OFF = 1 s: 5 s)  
No. of operations: 25,000 ope.

Change of pick-up and drop-out voltage

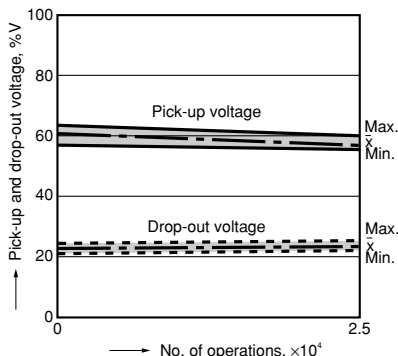

Change of contact resistance

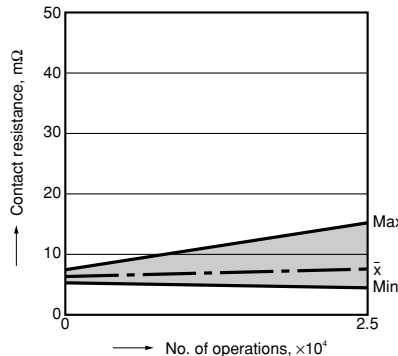

**DIMENSIONS** (mm inch)

The CAD data of the products with a **CAD Data** mark can be downloaded from: <http://industrial.panasonic.com/ac/e/>

**CAD Data**



**External dimensions**

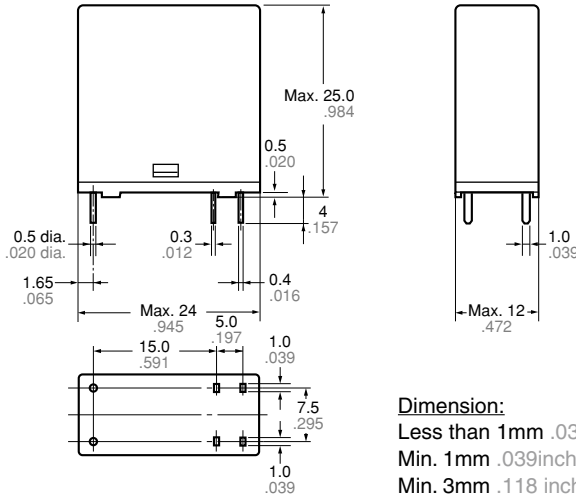

**PC board pattern (Bottom view)**

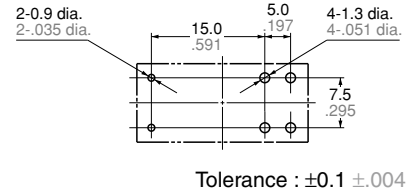

**Schematic (Bottom view)**



**Dimension:**

Less than 1mm .039inch:  
Min. 1mm .039inch less than 3mm .118 inch:  
Min. 3mm .118 inch:

**General tolerance**

±0.1 ±.004  
±0.2 ±.008  
±0.3 ±.012

**SAFETY STANDARDS**

Item	UL (Recognized)			CSA (Certified)		VDE (Certified)				TÜV (Certified)			TV rating (UL/CSA)	
	File No.	Contact rating	Cycles	File No.	Contact rating	File No.	Contact rating	Temp.	Cycles	File No.	Contact rating	Cycles	File No.	Contact rating
3A type	E43149	3A 125V AC	10 <sup>5</sup>	LR26550	3A 125V AC	40012000	3A 125V AC (cosφ=1.0)	70°C 158°F	10 <sup>4</sup>	B 12 06 13461 324	3A 125V AC (cosφ=1.0)	10 <sup>4</sup>	—	—
		3A 30V DC	6 × 10 <sup>3</sup>		3A 30V DC		3A 30V DC (0ms)	70°C 158°F	10 <sup>4</sup>		3A 30V DC (0ms)	10 <sup>4</sup>		
		5A 50V DC	6 × 10 <sup>3</sup>		5A 50V DC		—	—	—		—	—		
5A TV type	E43149	5A 277V AC	6 × 10 <sup>3</sup>	LR26550	5A 277V AC	40012000	5A 250V AC (cosφ=1.0)	70°C 158°F	10 <sup>4</sup>	B 12 06 13461 324	5A 250V AC (cosφ=1.0)	10 <sup>4</sup>	UL: E43149	TV-4
		5A 30V DC	6 × 10 <sup>3</sup>		5A 30V DC		5A 30V DC (0ms)	70°C 158°F	10 <sup>4</sup>		5A 30V DC (0ms)	10 <sup>4</sup>	CSA: LR26550	TV-4

**EN/IEC VDE Certified  
INSULATION CHARACTERISTIC (IEC61810-1)**

Item	Characteristic
Clearance/Creepage distance (IEC61810-1)	Min. 5.5mm/5.5mm
Category of protection (IEC61810-1)	RT II
Tracking resistance (IEC60112)	PTI 175
Insulation material group	III a
Over voltage category	III
Rated voltage	250V
Pollution degree	2
Type of insulation (Between contact and coil)	Reinforced insulation
Type of insulation (Between open contacts)	Micro disconnection

**NOTES**

1. For cautions for use, please read "GENERAL APPLICATION GUIDELINES".

---

Please contact .....

**Panasonic Corporation**

Electromechanical Control Business Division

■ 1006, Oaza Kadoma, Kadoma-shi, Osaka 571-8506, Japan  
[industrial.panasonic.com/ac/e/](http://industrial.panasonic.com/ac/e/)

**Panasonic**<sup>®</sup>

©Panasonic Corporation 2016