

**Applications**

- High Frequency Isolated DC-DC Converters with Synchronous Rectification for Telecom and Industrial Use
- High Frequency Buck Converters for Computer Processor Power
- Lead-Free

**Benefits**

- Ultra-Low Gate Impedance
- Very Low  $R_{DS(on)}$  at 4.5V  $V_{GS}$
- Fully Characterized Avalanche Voltage and Current

HEXFET® Power MOSFET

$V_{DSS}$	$R_{DS(on)}$ max(mΩ)	$I_D$
<b>40V</b>	<b>15.5@<math>V_{GS} = 10V</math></b>	<b>9.4A</b>

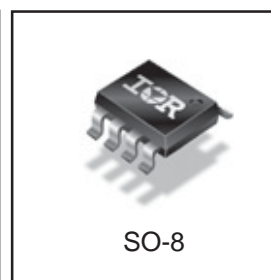
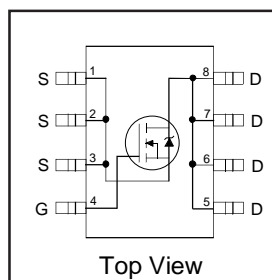

**Absolute Maximum Ratings**

Symbol	Parameter	Max.	Units
$V_{DS}$	Drain-Source Voltage	40	V
$V_{GS}$	Gate-to-Source Voltage	± 12	V
$I_D @ T_A = 25^\circ C$	Continuous Drain Current, $V_{GS} @ 10V$	9.4	A
$I_D @ T_A = 70^\circ C$	Continuous Drain Current, $V_{GS} @ 10V$	7.5	
$I_{DM}$	Pulsed Drain Current <sup>①</sup>	75	
$P_D @ T_A = 25^\circ C$	Maximum Power Dissipation	2.5	W
$P_D @ T_A = 70^\circ C$	Maximum Power Dissipation	1.6	W
	Linear Derating Factor	0.02	mW/°C
$T_J, T_{STG}$	Junction and Storage Temperature Range	-55 to + 150	°C

**Thermal Resistance**

Symbol	Parameter	Typ.	Max.	Units
$R_{\theta JL}$	Junction-to-Drain Lead	—	20	°C/W
$R_{\theta JA}$	Junction-to-Ambient <sup>④</sup>	—	50	

Notes ① through ⑤ are on page 8  
www.irf.com

# IRF7468PbF

International  
IR Rectifier

## Static @ T<sub>J</sub> = 25°C (unless otherwise specified)

	Parameter	Min.	Typ.	Max.	Units	Conditions
V <sub>(BR)DSS</sub>	Drain-to-Source Breakdown Voltage	40	—	—	V	V <sub>GS</sub> = 0V, I <sub>D</sub> = 250μA
ΔV <sub>(BR)DSS</sub> /ΔT <sub>J</sub>	Breakdown Voltage Temp. Coefficient	—	0.025	—	V/°C	Reference to 25°C, I <sub>D</sub> = 1mA
R <sub>DS(on)</sub>	Static Drain-to-Source On-Resistance	—	11.7	15.5	mΩ	V <sub>GS</sub> = 10V, I <sub>D</sub> = 9.4A ④
		—	13.0	17.0		V <sub>GS</sub> = 4.5V, I <sub>D</sub> = 7.5A ④
		—	18.0	35.0		V <sub>GS</sub> = 4.5V, I <sub>D</sub> = 4.7A ④
V <sub>GS(th)</sub>	Gate Threshold Voltage	0.8	—	2.0	V	V <sub>DS</sub> = V <sub>GS</sub> , I <sub>D</sub> = 250μA
I <sub>DSS</sub>	Drain-to-Source Leakage Current	—	—	20	μA	V <sub>DS</sub> = 32V, V <sub>GS</sub> = 0V
		—	—	100		V <sub>DS</sub> = 32V, V <sub>GS</sub> = 0V, T <sub>J</sub> = 125°C
I <sub>GSS</sub>	Gate-to-Source Forward Leakage	—	—	200	nA	V <sub>GS</sub> = 12V
	Gate-to-Source Reverse Leakage	—	—	-200		V <sub>GS</sub> = -12V

## Dynamic @ T<sub>J</sub> = 25°C (unless otherwise specified)

Symbol	Parameter	Min.	Typ.	Max.	Units	Conditions
g <sub>fs</sub>	Forward Transconductance	27	—	—	S	V <sub>DS</sub> = 20V, I <sub>D</sub> = 8.0A
Q <sub>g</sub>	Total Gate Charge	—	23	34	nC	I <sub>D</sub> = 8.0A
Q <sub>gs</sub>	Gate-to-Source Charge	—	6.4	9.6		V <sub>DS</sub> = 20V
Q <sub>gd</sub>	Gate-to-Drain ("Miller") Charge	—	6.7	10		V <sub>GS</sub> = 4.5V, ③
Q <sub>oss</sub>	Output Gate Charge	—	17	26		V <sub>GS</sub> = 0V, V <sub>DS</sub> = 16V
t <sub>d(on)</sub>	Turn-On Delay Time	—	7.6	—		ns
t <sub>r</sub>	Rise Time	—	2.3	—	I <sub>D</sub> = 8.0A	
t <sub>d(off)</sub>	Turn-Off Delay Time	—	20	—	R <sub>G</sub> = 1.8Ω	
t <sub>f</sub>	Fall Time	—	3.8	—	V <sub>GS</sub> = 4.5V ③	
C <sub>iss</sub>	Input Capacitance	—	2460	—	pF	V <sub>GS</sub> = 0V
C <sub>oss</sub>	Output Capacitance	—	490	—		V <sub>DS</sub> = 20V
C <sub>rss</sub>	Reverse Transfer Capacitance	—	38	—		f = 1.0MHz

## Avalanche Characteristics

Symbol	Parameter	Typ.	Max.	Units
E <sub>AS</sub>	Single Pulse Avalanche Energy②	—	160	mJ
I <sub>AR</sub>	Avalanche Current①	—	8.0	A

## Diode Characteristics

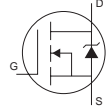
Symbol	Parameter	Min.	Typ.	Max.	Units	Conditions
I <sub>S</sub>	Continuous Source Current (Body Diode)	—	—	2.3	A	MOSFET symbol showing the integral reverse p-n junction diode. 
I <sub>SM</sub>	Pulsed Source Current (Body Diode) ①	—	—	74		
V <sub>SD</sub>	Diode Forward Voltage	—	0.81	1.3	V	T <sub>J</sub> = 25°C, I <sub>S</sub> = 8.0A, V <sub>GS</sub> = 0V ③
		—	0.65	—		T <sub>J</sub> = 125°C, I <sub>S</sub> = 8.0A, V <sub>GS</sub> = 0V ③
t <sub>rr</sub>	Reverse Recovery Time	—	45	68	ns	T <sub>J</sub> = 25°C, I <sub>F</sub> = 8.0A, V <sub>R</sub> = 20V
Q <sub>rr</sub>	Reverse Recovery Charge	—	76	110		di/dt = 100A/μs ③
t <sub>rr</sub>	Reverse Recovery Time	—	58	87	ns	T <sub>J</sub> = 125°C, I <sub>F</sub> = 8.0A, V <sub>R</sub> = 20V
Q <sub>rr</sub>	Reverse Recovery Charge	—	110	160		di/dt = 100A/μs ③

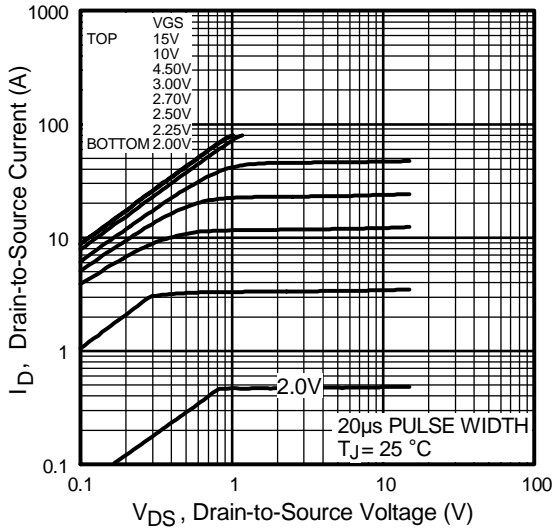

**Fig 1.** Typical Output Characteristics

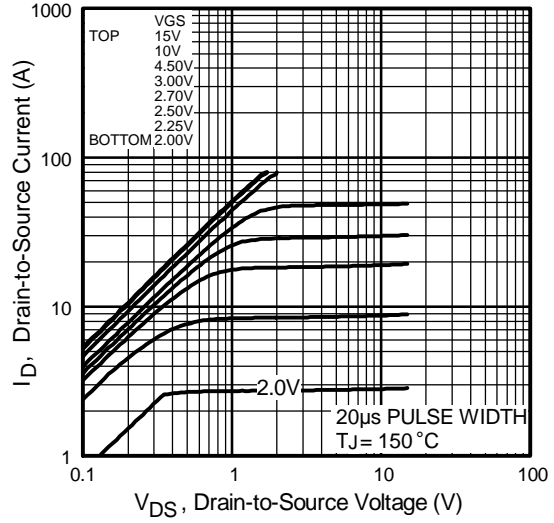

**Fig 2.** Typical Output Characteristics

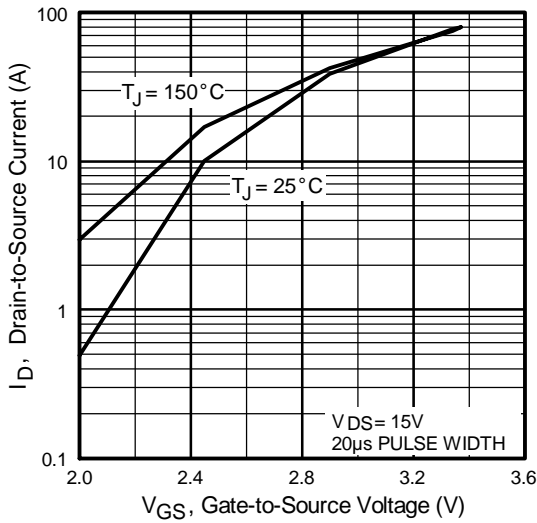

**Fig 3.** Typical Transfer Characteristics

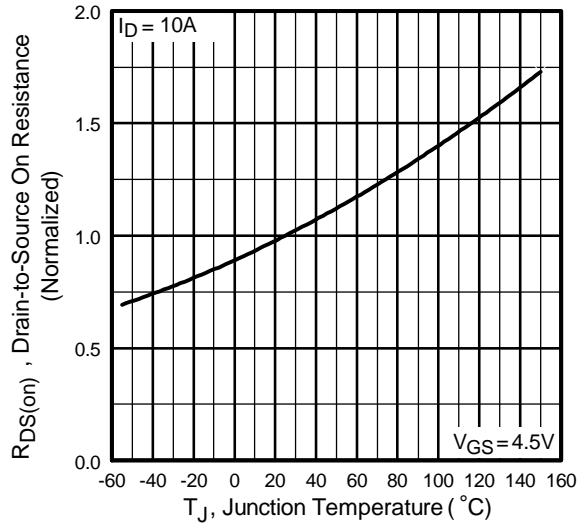

**Fig 4.** Normalized On-Resistance Vs. Temperature

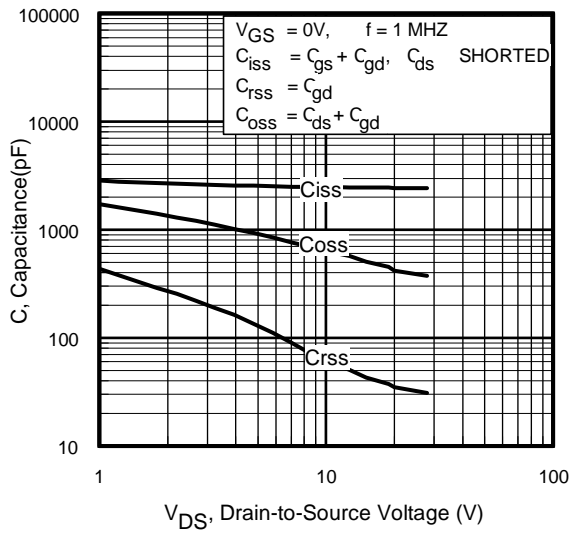

**Fig 5.** Typical Capacitance Vs. Drain-to-Source Voltage

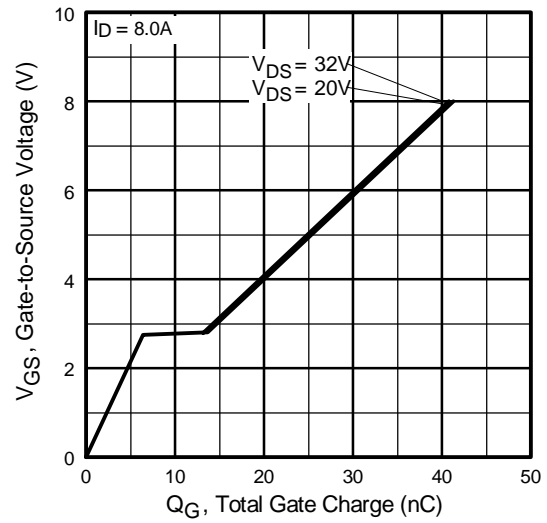

**Fig 6.** Typical Gate Charge Vs. Gate-to-Source Voltage

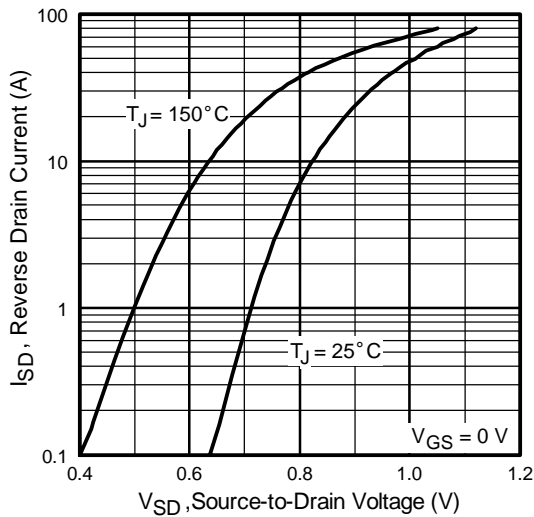

**Fig 7.** Typical Source-Drain Diode Forward Voltage

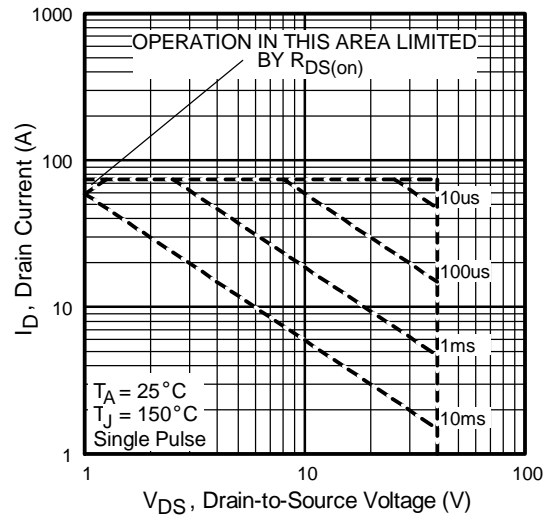
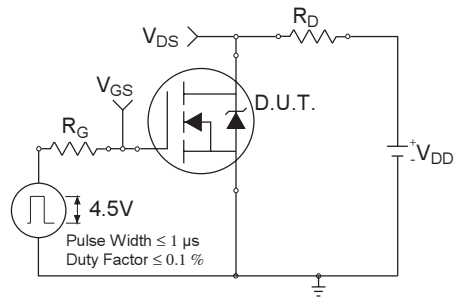
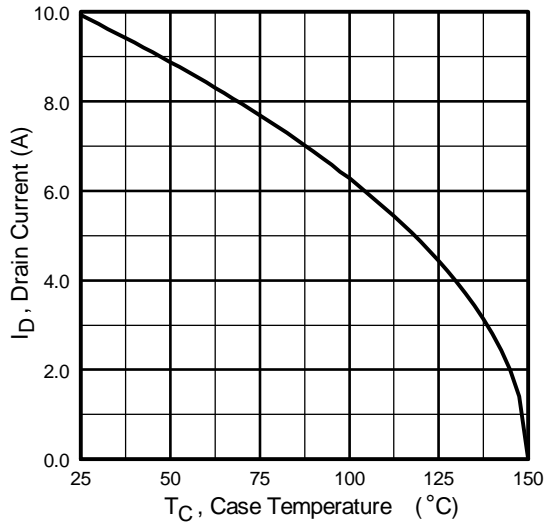

**Fig 8.** Maximum Safe Operating Area

**Fig 6. On-Resistance Vs. Drain Current**

International  
IR Rectifier

IRF7468PbF



**Fig 10a. Switching Time Test Circuit**

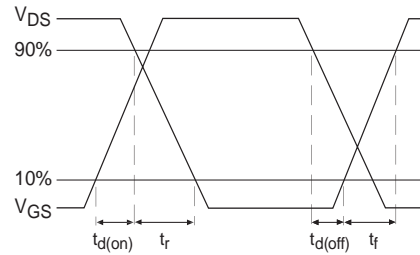

**Fig 10b. Switching Time Waveforms**

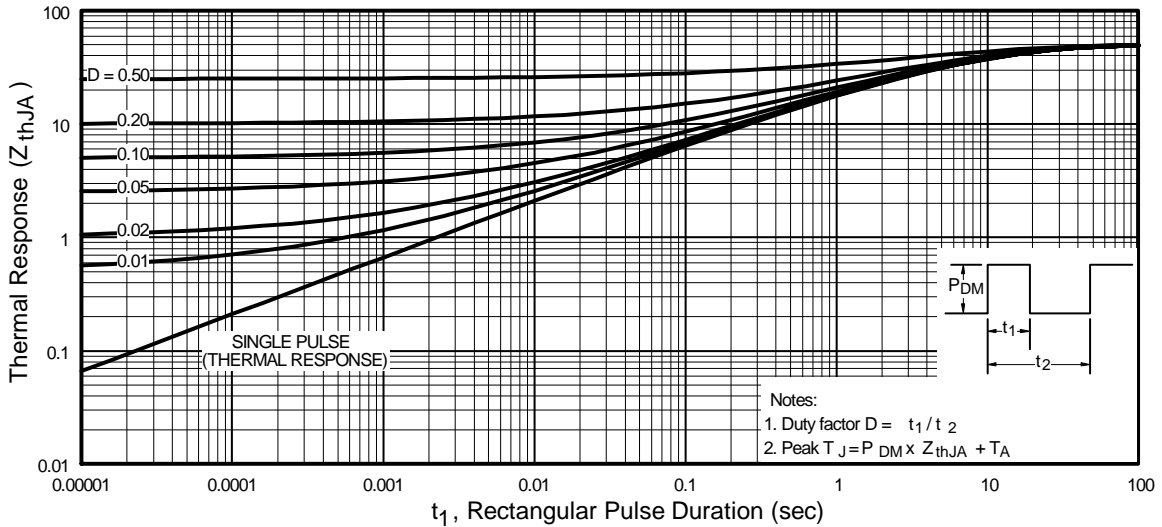

**Fig 10. Maximum Effective Transient Thermal Impedance, Junction-to-Case**

# IRF7468PbF

International  
**IR** Rectifier

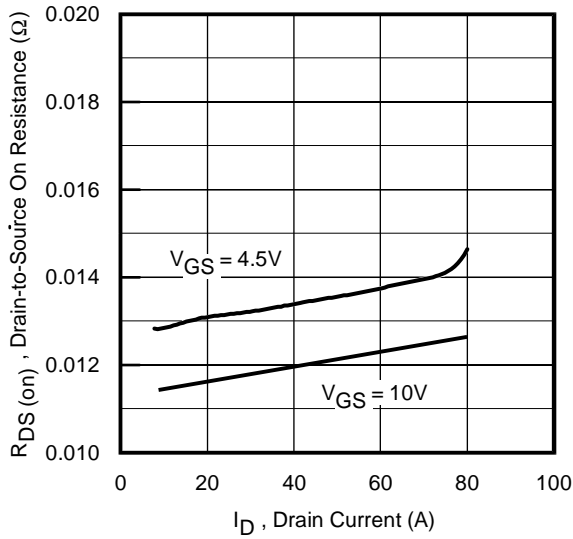

**Fig 12.** On-Resistance Vs. Drain Current

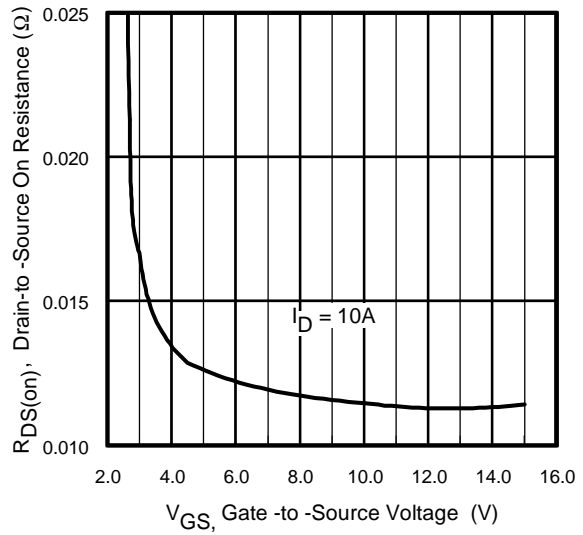

**Fig 13.** On-Resistance Vs. Gate Voltage

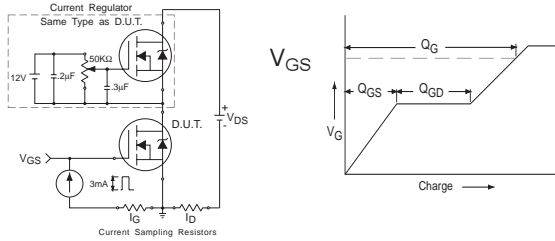

**Fig 13a&b.** Basic Gate Charge Test Circuit and Waveform

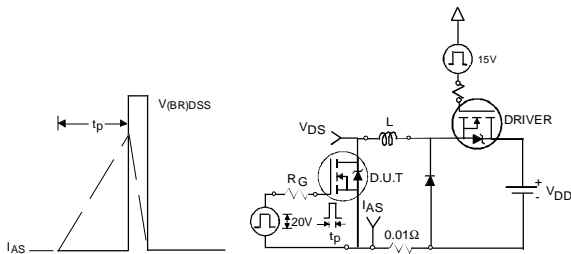

**Fig 14a&b.** Unclamped Inductive Test circuit and Waveforms

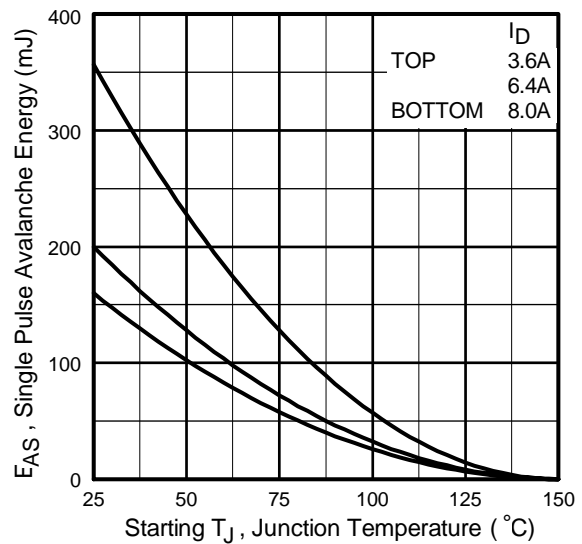

**Fig 14c.** Maximum Avalanche Energy Vs. Drain Current

## SO-8 Package Outline

Dimensions are shown in millimeters (inches)

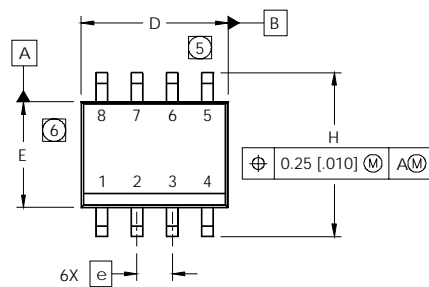

DIM	INCHES		MILLIMETERS	
	MIN	MAX	MIN	MAX
A	.0532	.0688	1.35	1.75
A1	.0040	.0098	0.10	0.25
b	.013	.020	0.33	0.51
c	.0075	.0098	0.19	0.25
D	.189	.1968	4.80	5.00
E	.1497	.1574	3.80	4.00
e	.050 BASIC		1.27 BASIC	
e1	.025 BASIC		0.635 BASIC	
H	.2284	.2440	5.80	6.20
K	.0099	.0196	0.25	0.50
L	.016	.050	0.40	1.27
y	0°	8°	0°	8°

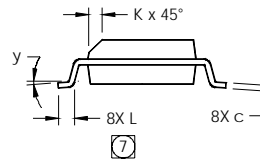
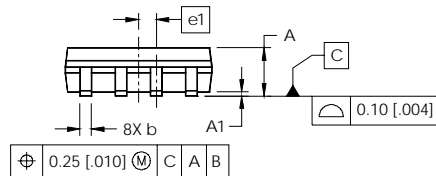

**NOTES:**

1. DIMENSIONING & TOLERANCING PER ASME Y14.5M-1994.
2. CONTROLLING DIMENSION: MILLIMETER
3. DIMENSIONS ARE SHOWN IN MILLIMETERS [INCHES].
4. OUTLINE CONFORMS TO JEDEC OUTLINE MS-012AA.
- 5 DIMENSION DOES NOT INCLUDE MOLD PROTRUSIONS. MOLD PROTRUSIONS NOT TO EXCEED 0.15 [0.006].
- 6 DIMENSION DOES NOT INCLUDE MOLD PROTRUSIONS. MOLD PROTRUSIONS NOT TO EXCEED 0.25 [0.010].
- 7 DIMENSION IS THE LENGTH OF LEAD FOR SOLDERING TO A SUBSTRATE.

**FOOTPRINT**

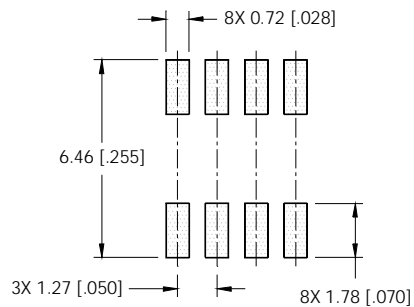

## SO-8 Part Marking

EXAMPLE: THIS IS AN IRF7101 (MOSFET)

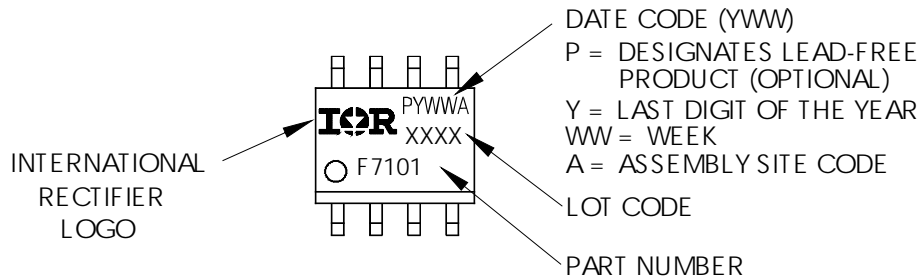

# IRF7468PbF

## SO-8 Tape and Reel

International  
**IR** Rectifier

Dimensions are shown in millimeters (inches)

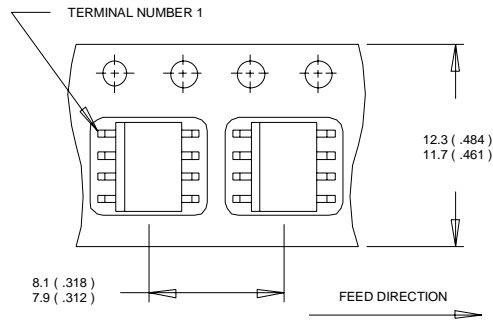

- NOTES:
1. CONTROLLING DIMENSION : MILLIMETER.
  2. ALL DIMENSIONS ARE SHOWN IN MILLIMETERS(INCHES).
  3. OUTLINE CONFORMS TO EIA-481 & EIA-541.

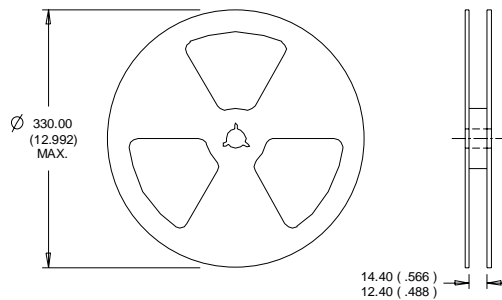

- NOTES :
1. CONTROLLING DIMENSION : MILLIMETER.
  2. OUTLINE CONFORMS TO EIA-481 & EIA-541.

### Notes:

- ① Repetitive rating; pulse width limited by max. junction temperature.
- ② Starting  $T_J = 25^\circ\text{C}$ ,  $L = 5.0\text{mH}$   
 $R_G = 25\Omega$ ,  $I_{AS} = 8.0\text{A}$ .
- ③ Pulse width  $\leq 400\mu\text{s}$ ; duty cycle  $\leq 2\%$ .
- ④ When mounted on 1 inch square copper board,  $t < 10$  sec

Data and specifications subject to change without notice.  
This product has been designed and qualified for the Consumer market.  
Qualifications Standards can be found on IR's Web site.

International  
**IR** Rectifier

IR WORLD HEADQUARTERS: 233 Kansas St., El Segundo, California 90245, USA Tel: (310) 252-7105  
TAC Fax: (310) 252-7903

Visit us at [www.irf.com](http://www.irf.com) for sales contact information.08/04  
[www.irf.com](http://www.irf.com)