

GRM42A5C3F390JW01#

indicates a package specification code.



< List of part numbers with package codes >
GRM42A5C3F390JW01L

Shape

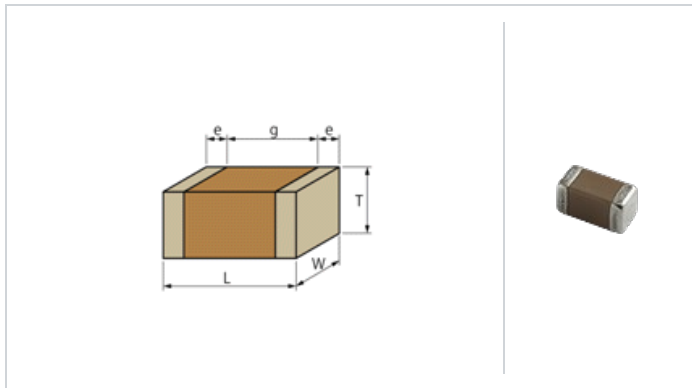

L size	4.5 ±0.3mm
W size	2.0 ±0.2mm
T size	1.0 +0.0/-0.3mm
External terminal width e	0.3mm min.
Distance between external terminals g	2.9mm min.
Size code in inch(mm)	1808 (4520M)

Notes

For LCD Backlight Inverters only

References

Packaging	Specifications	Minimum quantity
L	φ180mm Embossed taping	3000

Mass (typ.)	
1 piece	54mg

Specifications

Capacitance	39pF ±5%
Rated voltage	3150Vdc
Temperature characteristics (complied standard)	C0G(EIA)
Temperature coefficient	0±30ppm/°C
Temperature range of temperature characteristics	25 to 125°C
Operating temperature range	-55 to 125°C

Attention

- 1.This datasheet is downloaded from the website of Murata Manufacturing Co., Ltd. Therefore, it's specifications are subject to change or our products in it may be discontinued without advance notice. Please check with our sales representatives or product engineers before ordering.
- 2.This datasheet has only typical specifications because there is no space for detailed specifications. Therefore, please review our product specifications or consult the approval sheet for product specifications before ordering.