

MOC8101X, MOC8102X, MOC8103X,  
MOC8104X, MOC8105X MOC8101,  
MOC8102, MOC8103, MOC8104, MOC8105



**ISOCOM**  
COMPONENTS

**NON-BASE LEAD  
OPTICALLY COUPLED ISOLATOR  
PHOTOTRANSISTOR OUTPUT**



**APPROVALS**

- UL recognised, File No. E91231  
Package Code " GG "
- **'X' SPECIFICATION APPROVALS**
- VDE 0884 in 3 available lead form : -  
- STD  
G form  
- SMD approved to CECC 00802
- Certified to EN60950 by :-  
Nemko - Certificate No. P01102464

**DESCRIPTION**

The MOC8101, MOC8102, MOC8103, MOC8104, MOC8105 series of optically coupled isolators consist of infrared light emitting diode and NPN silicon photo transistor in a standard 6 pin dual in line plastic package with the base pin unconnected.

**FEATURES**

- Options :-  
10mm lead spread - add G after part no.  
Surface mount - add SM after part no.  
Tape & reel - add SMT & R after part no.
- High Isolation Voltage ( $5.3kV_{RMS}$ ,  $7.5kV_{PK}$ )
- Base pin unconnected for improved noise immunity in high EMI environment

**APPLICATIONS**

- DC motor controllers
- Industrial systems controllers
- Signal transmission between systems of different potentials and impedances

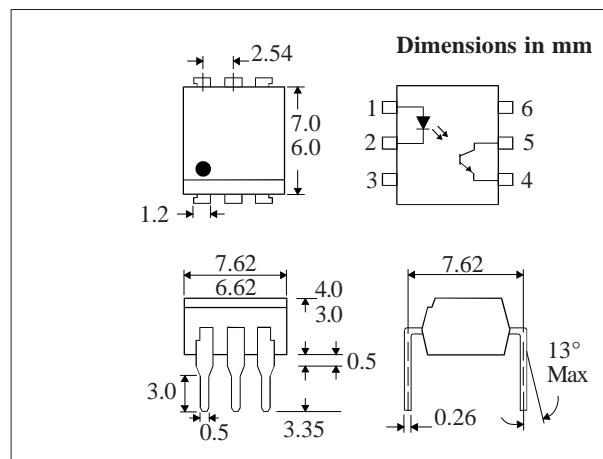
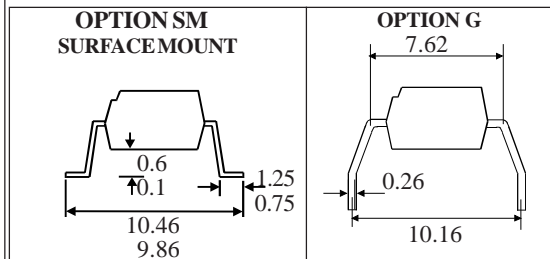

**ABSOLUTE MAXIMUM RATINGS  
(25°C unless otherwise specified)**

Storage Temperature	-55°C to +150°C
Operating Temperature	-55°C to +100°C
Lead Soldering Temperature (1/16 inch (1.6mm) from case for 10 secs)	260°C

**INPUT DIODE**

Forward Current	60mA
Reverse Voltage	6V
Power Dissipation	105mW

**OUTPUT TRANSISTOR**

Collector-emitter Voltage $BV_{CEO}$	30V
Emitter-collector Voltage $BV_{ECO}$	6V
Collector Current	50mA
Power Dissipation	160mW

**POWER DISSIPATION**

Total Power Dissipation	200mW
(derate linearly 2.67mW/°C above 25°C)	

**ISOCOM COMPONENTS 2004 LTD**  
Unit 25B, Park View Road West,  
Park View Industrial Estate, Brenda Road  
Hartlepool, Cleveland, TS25 1UD  
Tel: (01429) 863609 Fax: (01429) 863581

**ELECTRICAL CHARACTERISTICS (  $T_A = 25^\circ\text{C}$  Unless otherwise noted )**

PARAMETER		MIN	TYP	MAX	UNITS	TEST CONDITION
Input	Forward Voltage ( $V_F$ )	1.0	1.15	1.5	V	$I_F = 10\text{mA}$
	Reverse Current ( $I_R$ )			10	$\mu\text{A}$	$V_R = 6\text{V}$
Output	Collector-emitter Breakdown ( $BV_{CEO}$ ) ( Note 2 )	30			V	$I_C = 1\text{mA}$
	Emitter-collector Breakdown ( $BV_{ECO}$ )	6			V	$I_E = 100\mu\text{A}$
	Collector-emitter Dark Current ( $I_{CEO}$ )			50	nA	$V_{CE} = 10\text{V}$
Coupled	Output Collector Current ( $I_C$ ) ( Note 3 )					
	MOC8101	5.0		8.0	mA	$10\text{mA } I_F, 10\text{V } V_{CE}$
	MOC8102	7.3		11.7	mA	$10\text{mA } I_F, 10\text{V } V_{CE}$
	MOC8103	10.8		17.3	mA	$10\text{mA } I_F, 10\text{V } V_{CE}$
	MOC8104	16		25.6	mA	$10\text{mA } I_F, 10\text{V } V_{CE}$
	MOC8105	6.5		13.3	mA	$10\text{mA } I_F, 10\text{V } V_{CE}$
	Collector-emitter Saturation Voltage $V_{CE(SAT)}$		0.15	0.4	V	$5\text{mA } I_F, 0.5\text{mA } I_C$
	Input to Output Isolation Voltage $V_{ISO}$	5300 7500			$V_{RMS}$ $V_{PK}$	See note 1 See note 1
	Input-output Isolation Resistance $R_{ISO}$	$5 \times 10^{10}$			$\Omega$	$V_{IO} = 500\text{V}$ (note 1)
Response Time (Rise), tr		2		$\mu\text{s}$	$V_{CC} = 5\text{V}, I_F = 10\text{mA}$	
Response Time (Fall), tf		2		$\mu\text{s}$	$R_L = 75\Omega$ , (FIG 1)	

- Note 1 Measured with input leads shorted together and output leads shorted together.  
 Note 2 Special Selections are available on request. Please consult the factory.  
 Note 3 Production testing - limits verified with pulse test

**FIGURE 1**

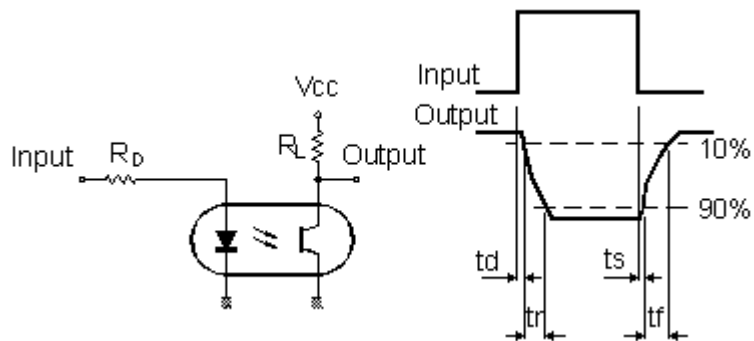

**Collector Power Dissipation vs. Ambient Temperature**

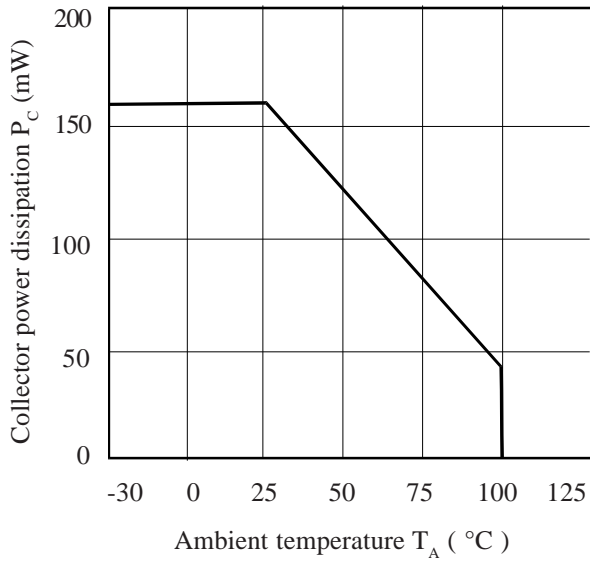

**Collector Current vs. Collector-emitter Voltage**

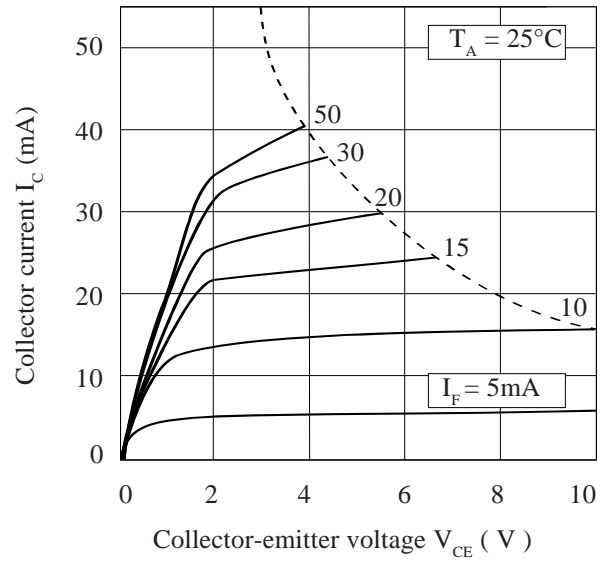

**Forward Current vs. Ambient Temperature**

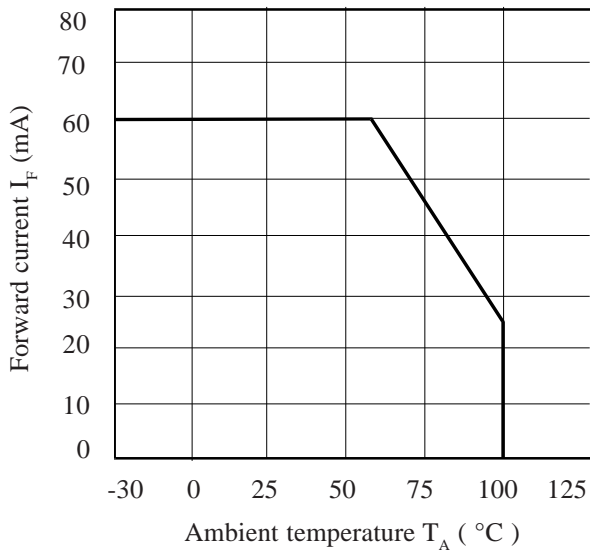

**Current Transfer Ratio vs. Forward Current**

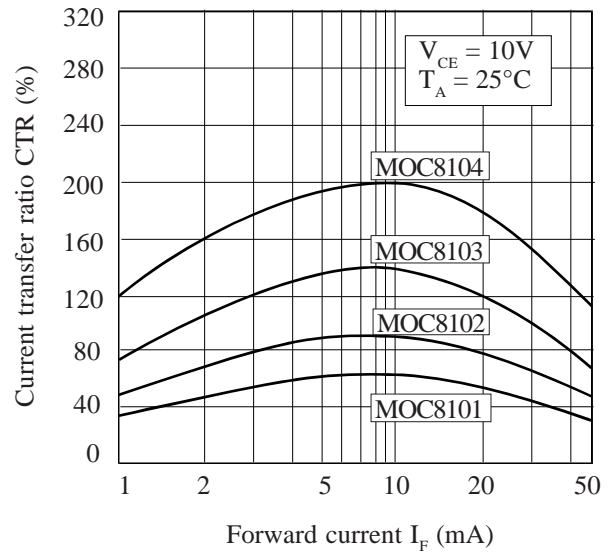

**Relative Current Transfer Ratio vs. Ambient Temperature**

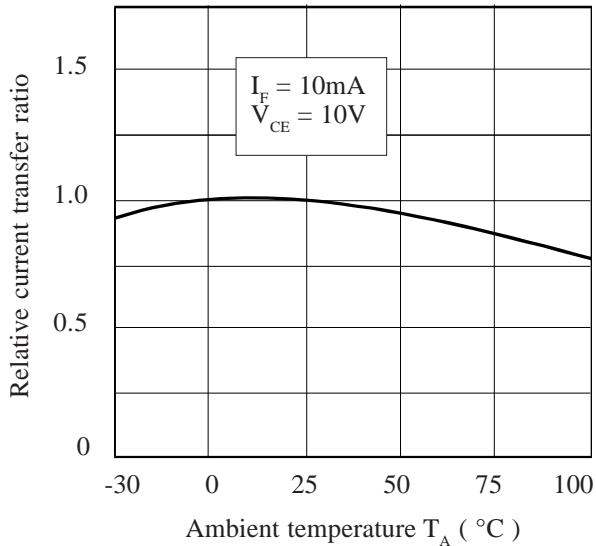

**Collector-emitter Saturation Voltage vs. Ambient Temperature**

