

ALM-GN002

GNSS LNA-Filter Front-End Module

with optional Differential Outputs



Data Sheet

Description

Avago Technologies' ALM-GN002 is an ultra low-noise GNSS (Global Navigation Satellite System) front-end module that combines a low-noise amplifier (LNA) with a GNSS FBAR post-LNA filter, supporting both GPS and GLONASS operating in 1565 ~ 1606 MHz frequency range. The module can be used both as a single-ended and pre-matched differential outputs. The LNA uses Avago Technologies' proprietary GaAs Enhancement-mode pHEMT process to achieve high gain with very low noise figure and high linearity. Noise figure distribution is very tightly controlled. A CMOS-compatible shutdown pin is included either for turning the LNA on/off, or for current adjustment. The integrated filter utilizes an Avago Technologies' leading-edge FBAR filter for exceptional rejection at Cellular, DCS, PCS and WLAN band frequencies. Bypass functionality with an external RF switch is possible with separate RF switching.

The ALM-GN002 is usable down to 1.8 V operation. It achieves low noise figures and high gain even at 1.8 V, making it suitable for use in critical low power GNSS band applications.

Component Image

Surface Mount (2.5 x 2.0 x 0.90) mm³ 8-lead MCOB

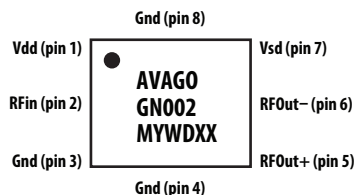

TOP VIEW

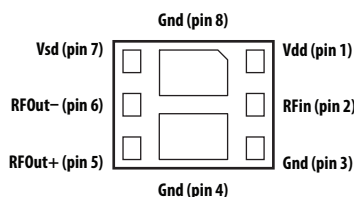

BOTTOM VIEW

Note:
 Package marking provides orientation and identification
 "GN002" = Product Code
 "M" = Manufacturing location
 "Y" = Year of manufacture
 "D" = Date Code
 "W" = Work week
 "XX" = Last four digits of lot number

Features

- Operating temperature range -40 to +85 °C
- Very Low Noise Figure: 0.97 dB typ.
- Exceptional Cell/DCS/PCS/WLAN-Band rejection
- Advanced GaAs E-pHEMT & FBAR Technology
- Shutdown current : < 1 μA
- CMOS compatible shutdown pin (SD)
- ESD : > 3 kV at RFin pin
- 0.90 mm typ. package thickness
- Adjustable bias current via single control voltage pin
- Small package dimension: 2.5(L) x 2.0(W) x 0.9(H) mm³
- Meets MSL3, Lead-free and halogen free

Specifications (Typical performance at 25° C)

At 1.575 GHz, Vdd = 2.7 V, Idd = 6.2 mA

- Gain = 17.2 dB
- NF = 0.97 dB
- IIP3 = 0 dBm, IP1dB = -8 dBm
- S11 = -8 dB, S22 = -13 dB
- Rejection at 824 – 915 MHz: 73 dBc
- Rejection at 1710 – 1785 MHz: 64 dBc
- Rejection at 1850 – 1910 MHz: 72 dBc
- Rejection at 2400 – 2570 MHz: 74 dBc

Application

- GNSS Front-end Module



Attention: Observe precautions for handling electrostatic sensitive devices.
 ESD Machine Model = 50 V
 ESD Human Body Model = 250 V
 Refer to Avago Application Note A004R: Electrostatic Discharge, Damage and Control.

Application Circuit (Differential output)

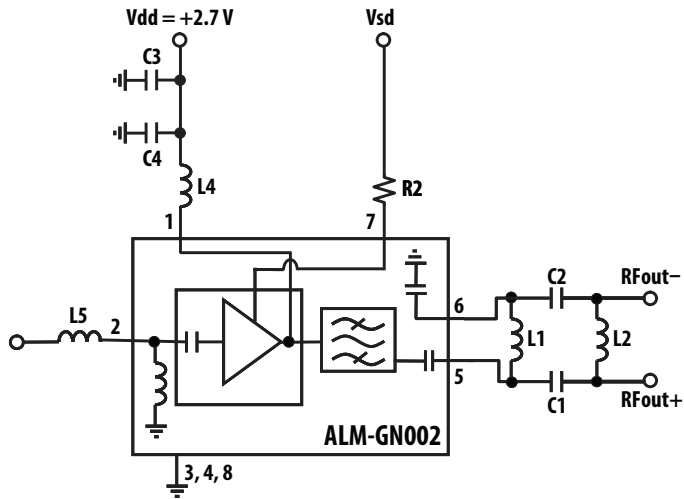

Absolute Maximum Rating^[1] $T_A=25^\circ\text{C}$

Symbol	Parameter	Units	Absolute Maximum
Vdd	Device Drain to Source Voltage ^[2]	V	4.0
Idd	Drain Current ^[2]	mA	15
$P_{in,max}$	CW RF Input Power (Vdd = 2.7 V, Idd = 6.2 mA)	dBm	15
P_{diss}	Total Power Dissipation ^[4]	mW	60
T_j	Junction Temperature	$^\circ\text{C}$	150
T_{STG}	Storage Temperature	$^\circ\text{C}$	-65 to 150

Thermal Resistance

Thermal Resistance^[3]
(Vdd = 2.7 V, Idd = 6.2 mA)
 $\theta_{jc} = 92^\circ\text{C/W}$

Notes:

1. Operation of this device in excess of any of these limits may cause permanent damage.
2. Assuming DC quiescent conditions.
3. Thermal resistance measured using Infra-Red measurement technique.
4. Board (module belly) temperature T_B is 25°C . Derate at $10.4\text{ mW}/^\circ\text{C}$ for $T_B > 144^\circ\text{C}$.

Electrical Specifications

T_A = 25° C, Freq = 1.575 GHz and 1.6017 GHz, measured on differential output board as in Figure 1.

Table 1. Performance at V_{dd} = V_{sd} = 2.7 V, I_{dd} = 6.2 mA (R₂ = 3.3 kohm) nominal operating conditions

Symbol	Parameter and Test Condition	Unit	At 1.575 GHz			At 1.6017 GHz		
			Min.	Typ.	Max.	Min.	Typ.	Max.
Passband Performance								
G ^[1]	Gain	dB	15	17.2	19	13	15.8	18
NF ^[2]	Noise Figure	dB	-	0.97	1.4	-	1.08	1.5
IP1dB	Input 1dB Compressed Power	dBm	-	-8	-	-	-8	-
IIP3 ^[3]	Input 3 rd Order Intercept Point (2-tone at Fc +/- 2.5MHz)	dBm	-	0	-	-	0	-
S11	Input Return Loss	dB	-	-8	-	-	-8	-
S22 / S33	Output Return Loss (RFOut+/RFOut-)	dB	-	-13	-	-	-8	-
S12	Reverse Isolation	dB	-	-30	-	-	-31	-
CMRR	Common mode rejection ratio	dB	25	32	-	25	33	-
I _{dd}	Supply DC current at Shutdown (SD) voltage V _{sd} = 2.7 V	mA	-	6.2	10	-	-	-
I _{sh}	Shutdown Current at V _{sd} = 0 V	μA	-	0.5	-	-	-	-
Out of Band Performance								
B5/CDMA/GSM850/B8/GSM900 Rejection	Worst-case relative to 1.575GHz within (824-915) MHz band, tested at 915 MHz	dBc	67	73.1	-	-	-	-
B3/GSM1700 Rejection	Worst-case relative to 1.575GHz within (1710-1785) MHz band, tested at 1710 MHz	dBc	50	63.5	-	-	-	-
B2/CDMA1900/GSM1900 Rejection	Worst-case relative to 1.575GHz within (1850-1910) MHz band, tested at 1850 MHz	dBc	58	71.6	-	-	-	-
ISM/WiMax Rejection	Worst-case relative to 1.575GHz within (2400-2570) MHz band, tested at 2400 MHz	dBc	63	73.6	-	-	-	-
IP1dB _{915MHz}	Input 1dB gain compression interferer signal level at 915 MHz	dBm	-	-5	-	-	-	-
IP1dB _{1710MHz}	Input 1dB gain compression interferer signal level at 1710 MHz	dBm	-	-12	-	-	-	-
IP1dB _{1850MHz}	Input 1dB gain compression interferer signal level at 1850 MHz	dBm	-	-8	-	-	-	-
IP1dB _{2400MHz}	Input 1dB gain compression interferer signal level at 2400 MHz	dBm	-	3	-	-	-	-
OOB IIP2 ^[4]	Out of Band Input 2 nd Order Intercept Point (2-tone at 824.6 MHz and 2400 MHz)	dBm	-	12	-	-	-	-
OOB IIP3 ^[5]	Out of Band Input 3 rd Order Intercept Point (2-tone at 1712.7 MHz and 1850 MHz)	dBm	-	23	-	-	-	-
H2 _{788MHz} ^[6]	2 nd Harmonics of signal at 788 MHz	dBm	-	-34	-	-	-	-

Table 2. Performance at Vdd = Vsd = 1.8 V, Idd = 4 mA (R2 = 2.2 kohm) nominal operating conditions

Symbol	Parameter and Test Condition	Units	At 1.575GHz (Typ.)
Passband Performance			
G	Gain	dB	15.2
NF ^[2]	Noise Figure	dB	1.22
IP1dB	Input 1dB Compressed Power	dBm	-11.5
IIP3 ^[3]	Input 3 rd Order Intercept Point (2-tone at Fc +/- 2.5 MHz)	dBm	-5
S11	Input Return Loss	dB	-7
S22	Output Return Loss	dB	-8
S12	Reverse Isolation	dB	-31
CMRR	Common mode rejection ratio	dB	31
Idd	Supply DC current at Shutdown (SD) voltage Vsd = 2.7 V	mA	4
Ish	Shutdown Current at Vsd = 0 V	uA	0.5
Out of Band Performance			
B5/CDMA/GSM850/B8/ GSM900 Rejection	Worst-case relative to 1.575 GHz within (824-915) MHz band, tested at 915 MHz	dBc	74
B3/GSM1700 Rejection	Worst-case relative to 1.575 GHz within (1710-1785) MHz band, tested at 1710 MHz	dBc	59
B2/CDMA1900/ GSM1900 Rejection	Worst-case relative to 1.575 GHz within (1850-1910) MHz band, tested at 1850 MHz	dBc	80
ISM / WiMax Rejection	Worst-case relative to 1.575 GHz within (2400-2570) MHz band, tested at 2400 MHz	dBc	82
IP1dB _{915MHz}	Input 1dB gain compression interferer signal level at 915 MHz	dBm	-5
IP1dB _{1710MHz}	Input 1dB gain compression interferer signal level at 1710 MHz	dBm	-12
IP1dB _{1850MHz}	Input 1dB gain compression interferer signal level at 1850 MHz	dBm	-9
IP1dB _{2400MHz}	Input 1dB gain compression interferer signal level at 2400 MHz	dBm	2
OOB IIP2 ^[4]	Out of Band Input 2 nd Order Intercept Point (2-tone at 824.6 MHz and 2400 MHz)	dBm	7
OOB IIP3 ^[5]	Out of Band Input 3 rd Order Intercept Point (2-tone at 1712.7 MHz and 1850 MHz)	dBm	23
H2 _{788MHz} ^[6]	2 nd Harmonics of signal at 788 MHz	dBm	-31

Notes:

1. Measured with differential outputs
2. Losses from demoboard deembedded
3. 1.575 GHz IIP3 test condition: F_{RF1} = 1572.5 MHz, F_{RF2} = 1577.5 MHz with input power of -20 dBm per tone measured at the worst case side band
4. OOB Input IP2 test condition: Input jammer tones: 824.6 MHz at -17 dBm and 2400 MHz at -40 dBm. Output IM2 tone at 1575.4 MHz
5. 1.575 GHz IIP3 test condition: F_{RF1} = 1712.7 MHz, F_{RF2} = 1850 MHz with input power of 10 dBm per tone measured at the worst case side band
6. H2 test condition: Input tone: 788 MHz at -17 dBm

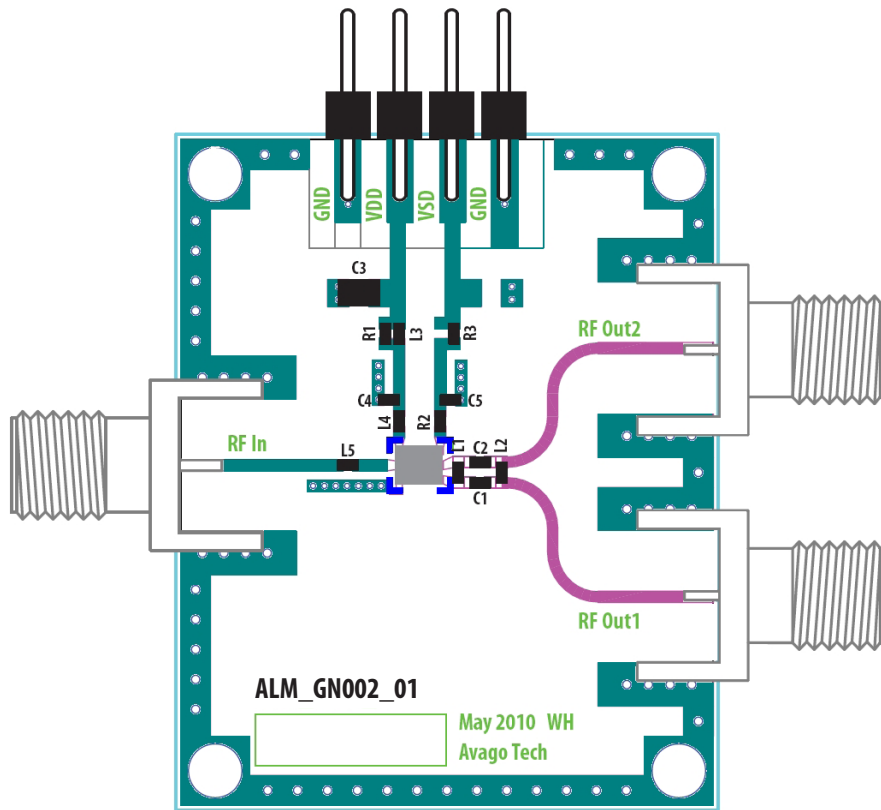

Circuit Symbol	Size	Description
L1	0402	5.6 nH Inductor (Taiyo Yuden HK10055N6S-T)
L2	0402	10 nH Inductor (Taiyo Yuden HK100510NJ-T)
L3	0402	22 nH Inductor (Taiyo Yuden HK100522NJ-T)
L4	0402	2.2 nH Inductor (Taiyo Yuden HK10052N2S-T)
L5	0402	10 nH Inductor (Taiyo Yuden HK100510NJ-T)
C1	0402	1.6 pF Capacitor (Murata GJM1555C1H1R6CB01D)
C2	0402	100 pF Capacitor (Murata GRM1555C1H101JD01E)
C3	0805	0.1 μ F Capacitor (Murata GRM21BR71H104KA01L)
C4	0402	33 pF Capacitor (Murata GRM1555C1H330JZ01D)
C5	0402	6.8 pF Capacitor (Murata GJM1555C1H6R8DB01D)
R1	0402	12 Ohm Resistor (Rohm MCR01MZSJ120)
R2	0402	3.3 kohm (KOA RK73B1ETTP332J)
R3	0402	0 Ohm (Kamaya RMC1/16S-JPTH)

Figure 1. Demoboard and application circuit components table for differential output

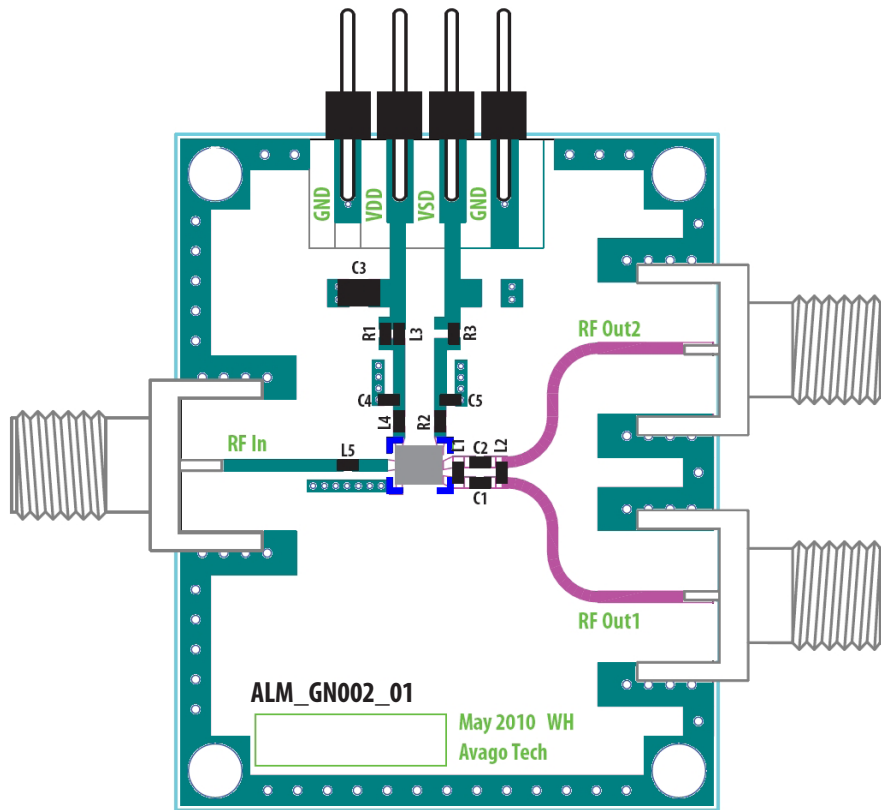

Circuit Symbol	Size	Description
L1	0402	Not applicable
L2	0402	Not applicable
L3	0402	22 nH Inductor (Taiyo Yuden HK100522NJ-T)
L4	0402	2.2 nH Inductor (Taiyo Yuden HK10052N2S-T)
L5	0402	10 nH Inductor (Taiyo Yuden HK100510NJ-T)
C1	0402	0 Ohm Resistor (Kamaya RMC1/16S-JPTH)
C2	0402	Not applicable
C3	0805	0.1 μ F Capacitor (Murata GRM21BR71H104KA01L)
C4	0402	33 pF Capacitor (Murata GRM1555C1H330JZ01D)
C5	0402	6.8 pF Capacitor (Murata GJM1555C1H6R8DB01D)
R1	0402	12 Ohm Resistor (Rohm MCR01MZS1120)
R2	0402	3.3 kohm Resistor (KOA RK73B1ETTP332J)
R3	0402	0 Ohm Resistor (Kamaya RMC1/16S-JPTH)

Figure 2. Demoboard and application circuit components table for single-ended output (for illustration purposes, refer to application notes for data)

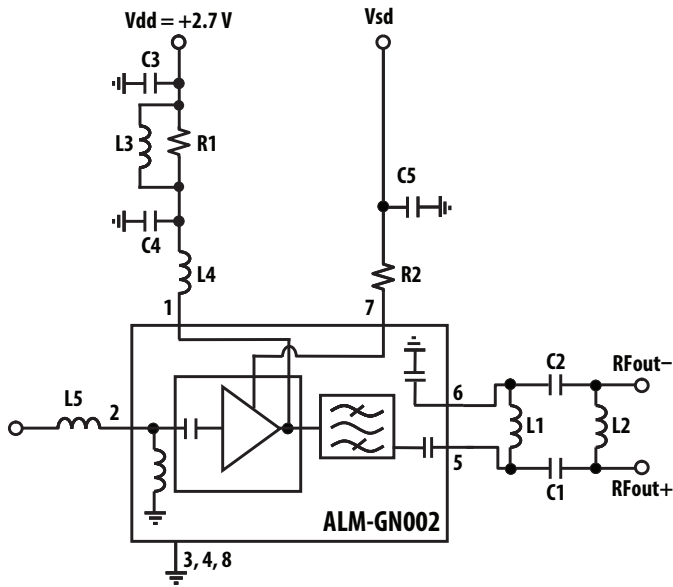

Figure 3a. Application Circuit – Differential outputs

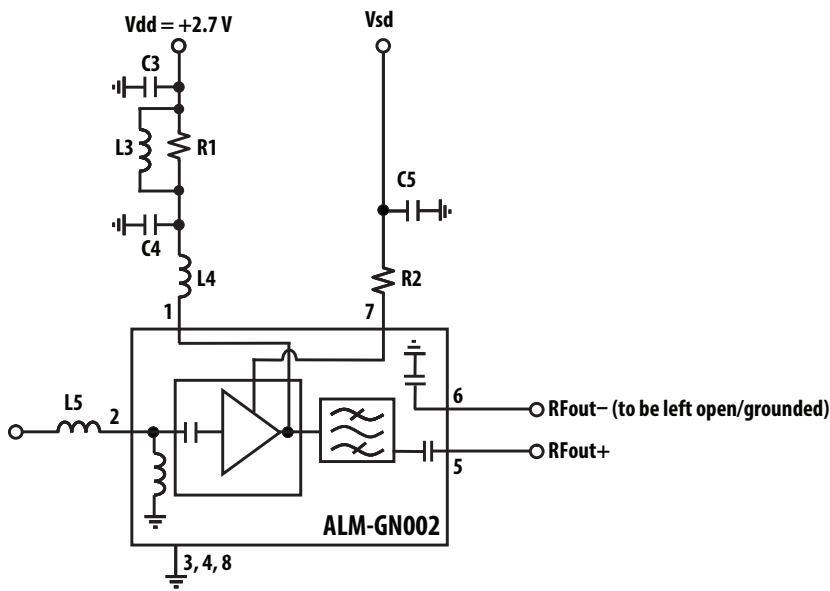

Figure 3b. Application Circuit – Single-ended output

Notes:

- The ALM-GN002 can be operated with supply voltage (Vdd) from 1.8 V to 3.6 V. Vsd can operate from 1 V to Vdd.
- RF input match is achieved by a single series inductor, L5. It is used to match the module for best NF and S11.
- The differential outputs of the module are already pre-matched. Suggested matching components are shown as L1, L2, C1 and C2 for 100 ohm differential load impedance. In practice, they may be tuned to match the RF GPS System on Chip (SoC) with a different input impedance, or an SoC that is located a significant distance away from the module such that the phase shift of the transmission lines connecting the module and SoC are not negligible.
- Best noise performance is obtained using high-Q wirewound inductors. This circuit demonstrates that low noise figures are obtainable with standard 0402 chip inductors.
- C3 and C4 are bypass capacitors for RF and low frequency stability and linearity .
- Bias control is achieved by either varying the Vsd voltage with/ without R2, or fixing the Vsd voltage to Vdd and adjusting R2 for the desired current.
- L3 and R1 isolates the demoboard from external disturbances during measurement. They are not needed in actual application. Likewise, C5 mitigate the effect of external noise pickup on the Vsd line. This component is not required in actual operation.

ALM-GN002 Typical Performance Curves

Unless otherwise stated, all measurements are made with circuit of Figure 13a using demoboard of Figure 1 with $V_{dd} = 2.7\text{ V}$, $I_{dd} = 6.2\text{ mA}$ ($R_2 = 3.3\text{ kohm}$, $V_{sd} = 2.7\text{ V}$) at $25\text{ }^\circ\text{C}$.

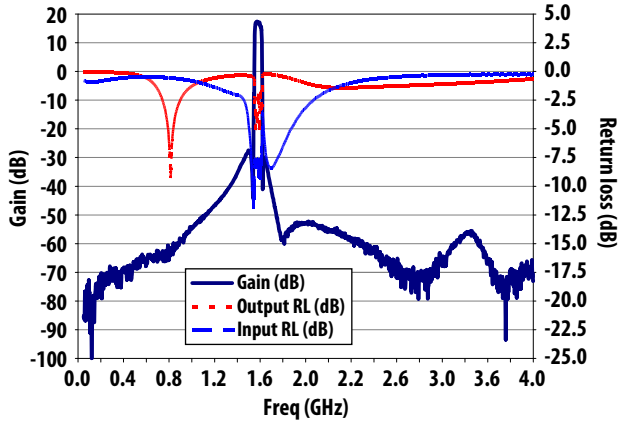

Figure 4a. Typical S-Parameter Plot

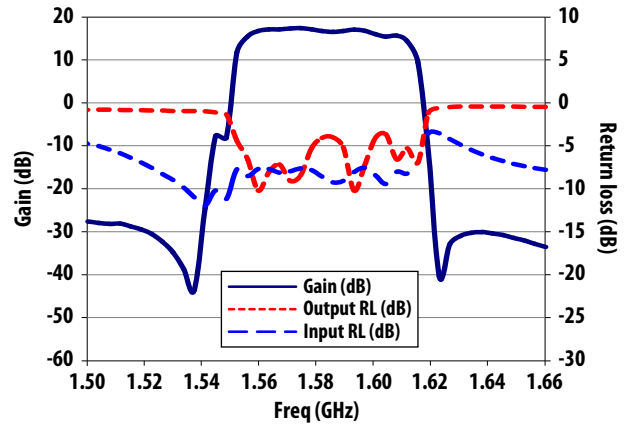

Figure 4b. Passband response of typical S-Parameter Plot

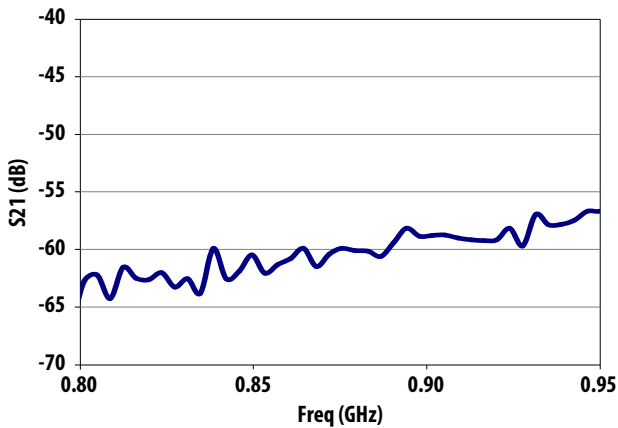

Figure 4c. Rejection plot for (800 – 950) MHz

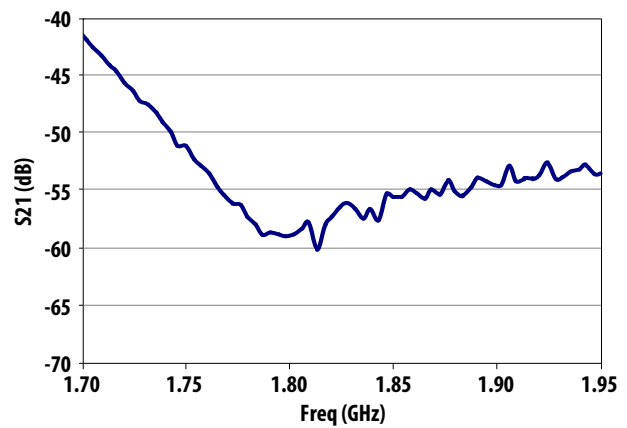

Figure 4d. Rejection plot for (1700 – 1950) MHz

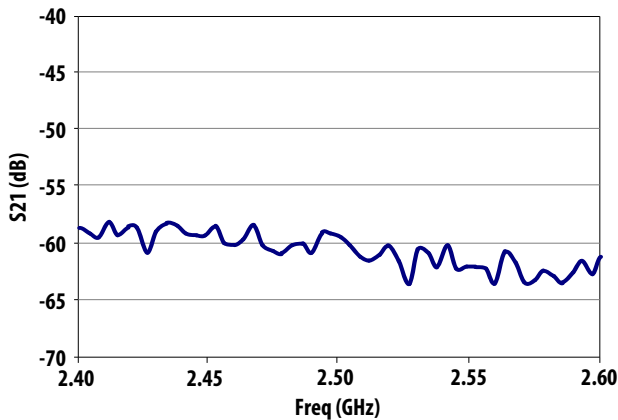

Figure 4e. Rejection plot for (2400 – 2600) MHz

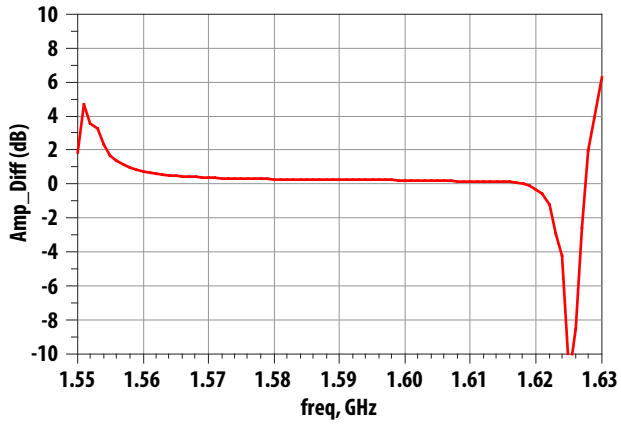

Figure 5. Amplitude imbalance for RFout+ and RFout- ports

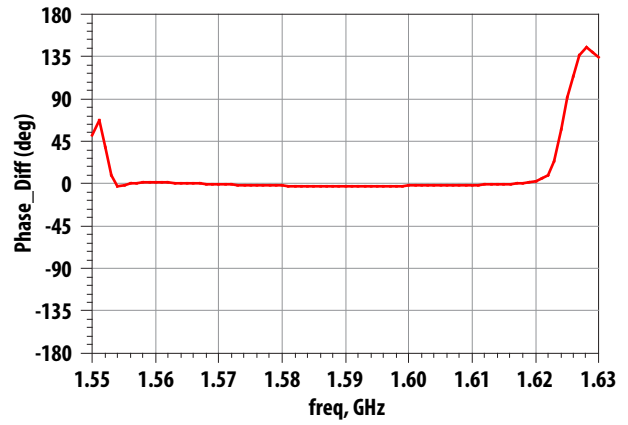

Figure 6. Phase imbalance for RFout+ and RFout- ports

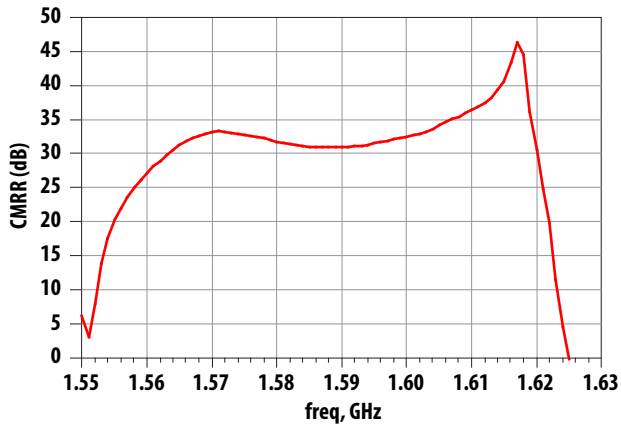

Figure 7. Common-mode rejection ratio

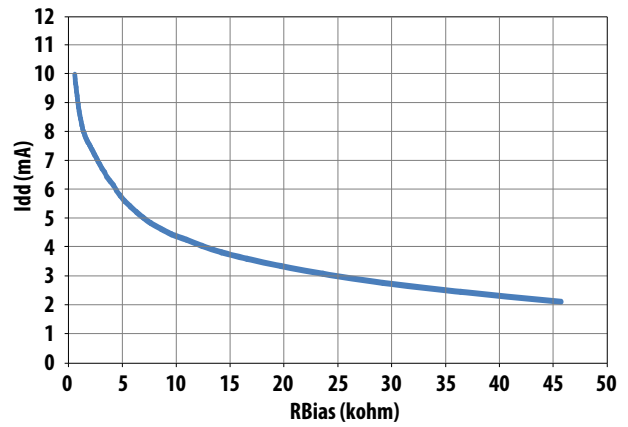

Figure 8. Idd vs. R2

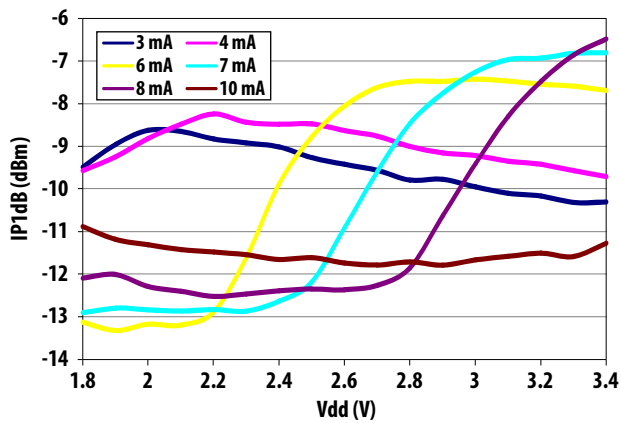

Figure 9. IP1dB vs. Vdd. Measurements made with RFout- port terminated with 50 ohm load to ground

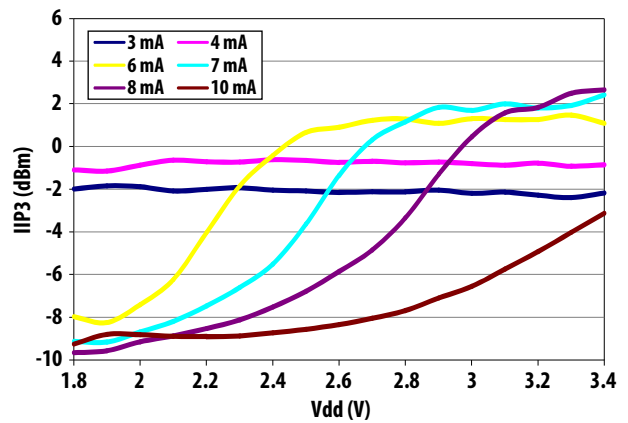

Figure 10. IIP3 vs. Vdd. Measurements made with RFout- port terminated with 50 ohm load to ground

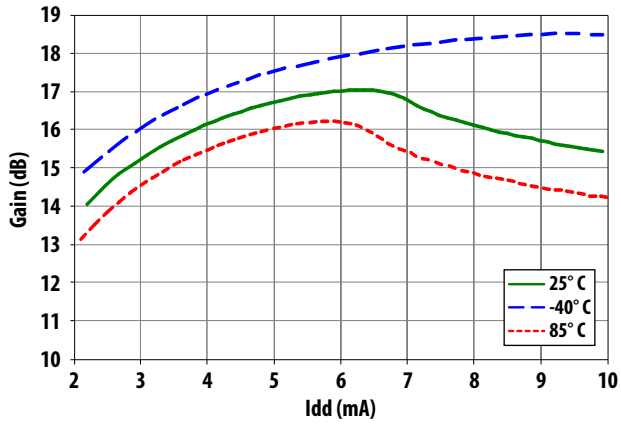

Figure 11. Gain vs. Idd at 1.575 GHz

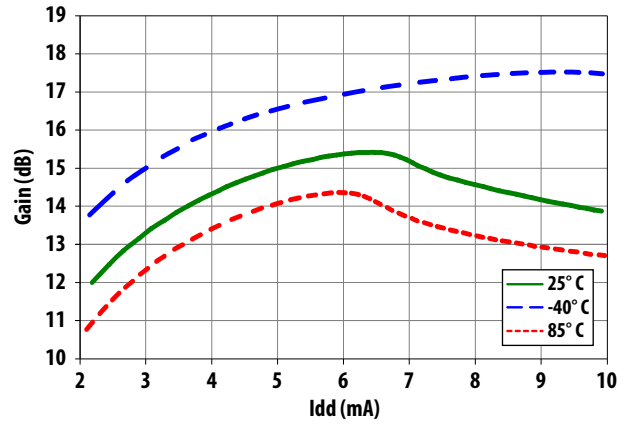

Figure 12. Gain vs. Idd at 1.6017 GHz

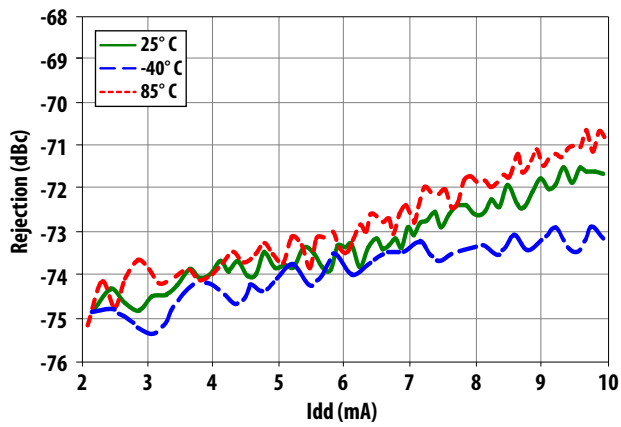

Figure 13. Rejection at 915 MHz relative to 1.575 GHz vs. Idd

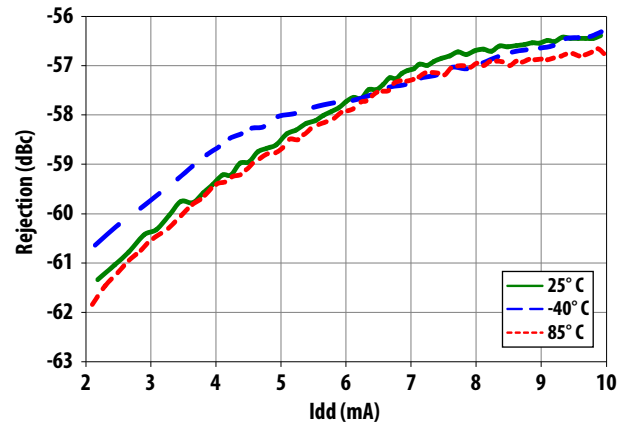

Figure 14. Rejection at 1710 MHz relative to 1.575 GHz vs. Idd

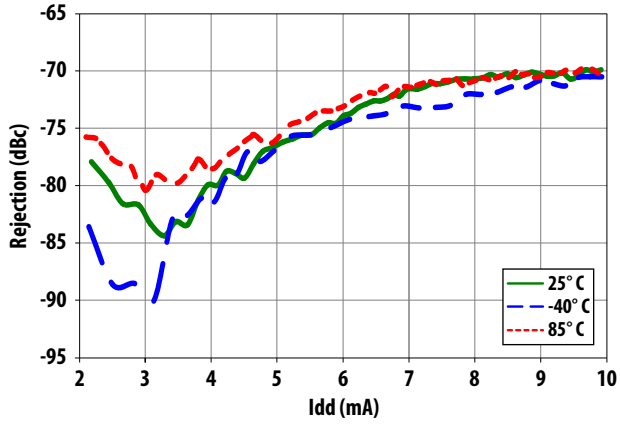

Figure 15. Rejection at 1850 MHz relative to 1.575 GHz vs. Idd

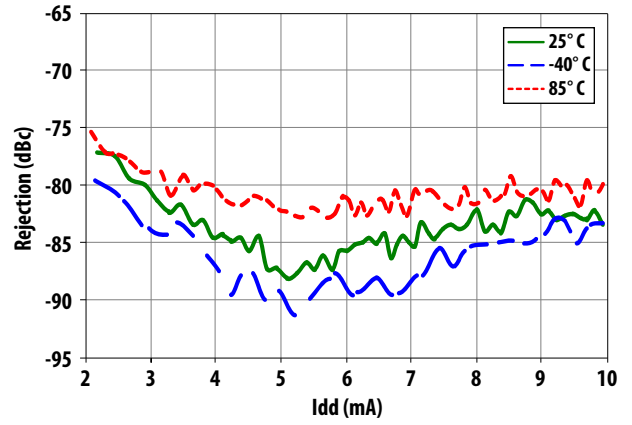

Figure 16. Rejection at 2400 MHz relative to 1.575 GHz vs. Idd

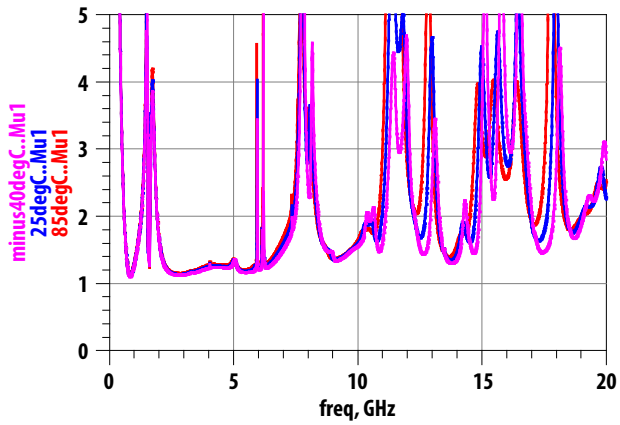

Figure 17. Edwards-Sinsky Output Stability Factor (Mu)

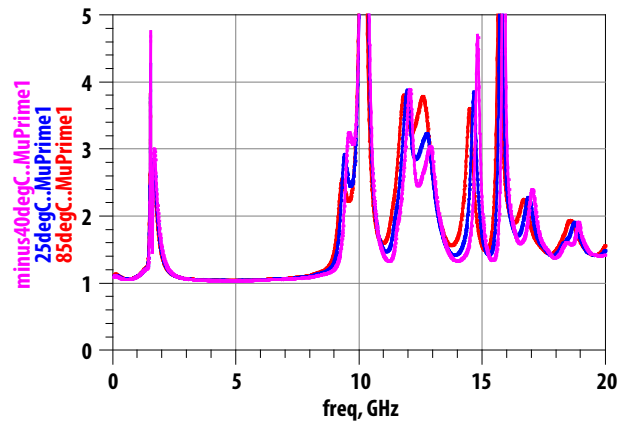

Figure 18. Edwards-Sinsky Input Stability Factor (Mu')

ALM-GN002 Typical Performance Curves

Unless otherwise stated, all measurements are made with circuit of Figure 13a using demoboard of Figure 1 with $V_{dd} = 1.8\text{ V}$, $I_{dd} = 4\text{ mA}$ ($R2 = 2.2\text{ kohm}$, $V_{sd} = 1.8\text{ V}$) at 25° C .

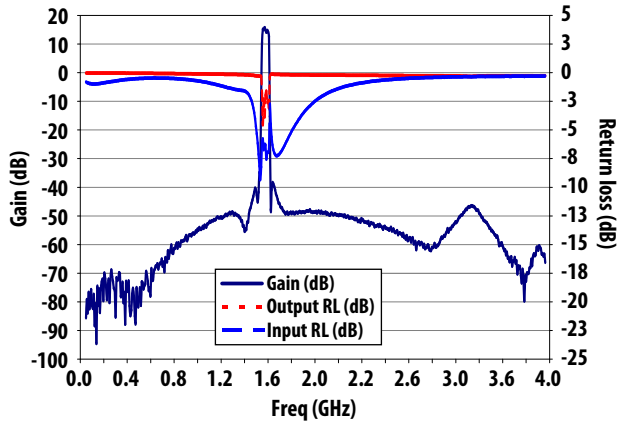

Figure 19a. Typical S-Parameter Plot

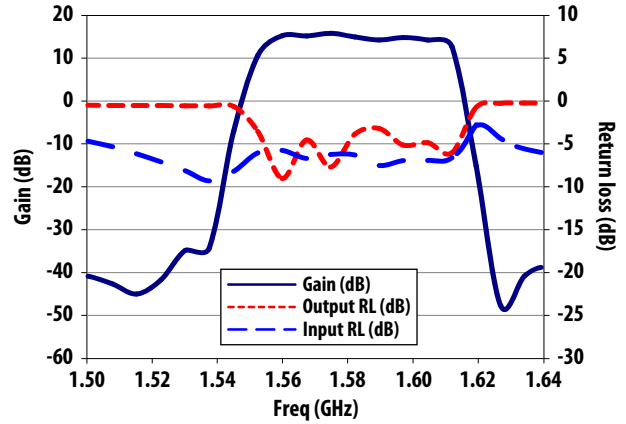

Figure 19b. Passband response of typical S-Parameter Plot

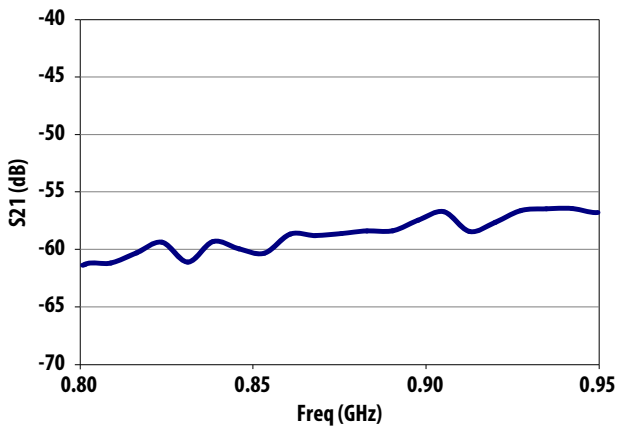

Figure 19c. Rejection plot for (800 – 950) MHz

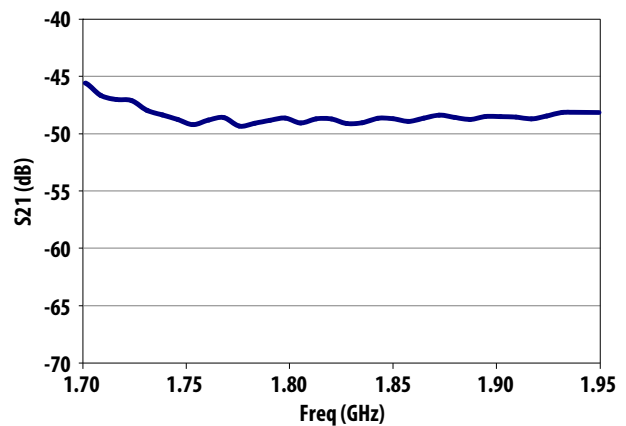

Figure 19d. Rejection plot for (1700 – 1950) MHz

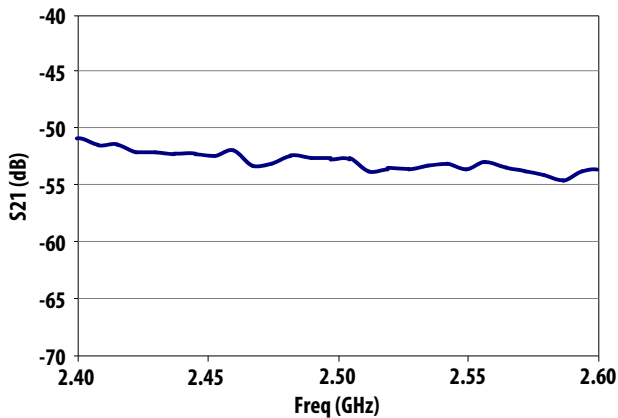

Figure 19e. Rejection plot for (2400 – 2600) MHz

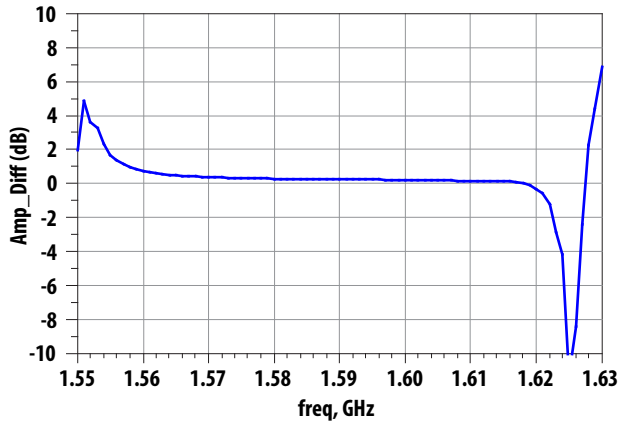

Figure 20. Amplitude difference between RFout+ and RFout- ports

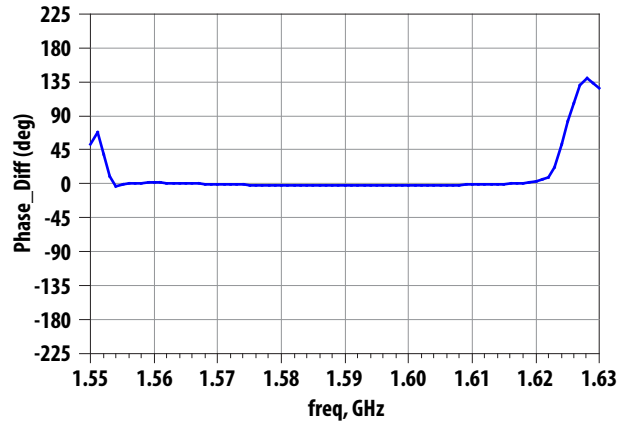

Figure 21. Phase difference between RFout+ and RFout- ports

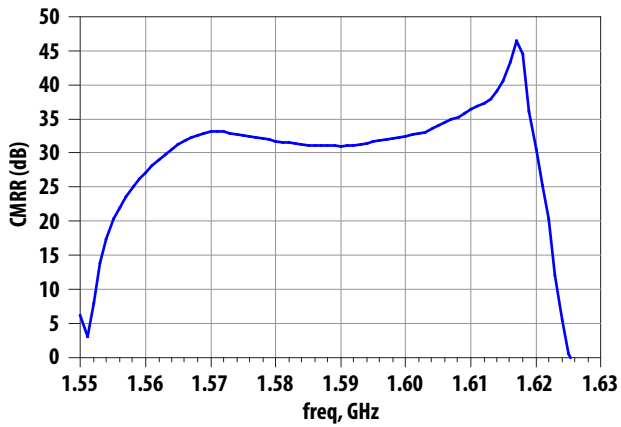

Figure 22. Common-mode rejection ratio

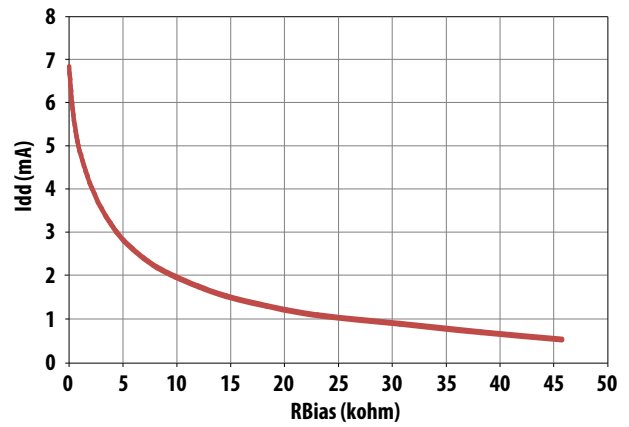

Figure 23. Idd vs. R2

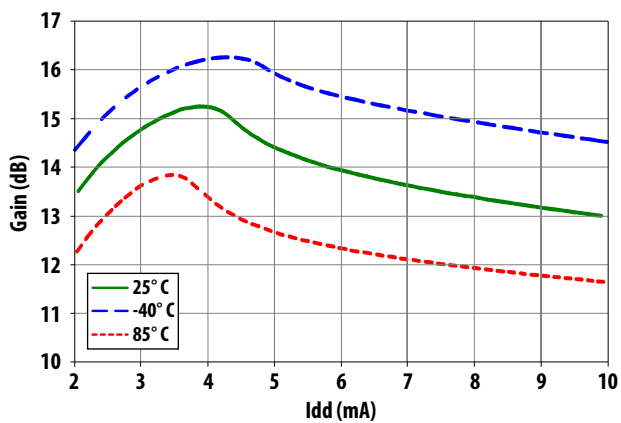

Figure 24. Gain vs. Idd at Vdd = 1.8 V at 1.575 GHz

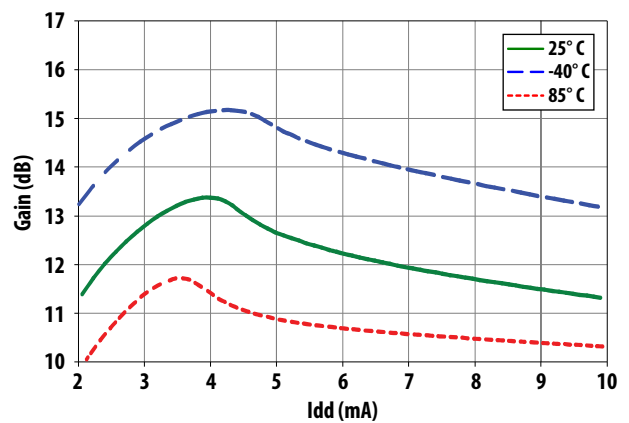

Figure 25. Gain vs. Idd at Vdd = 1.8 V at 1.6017 GHz

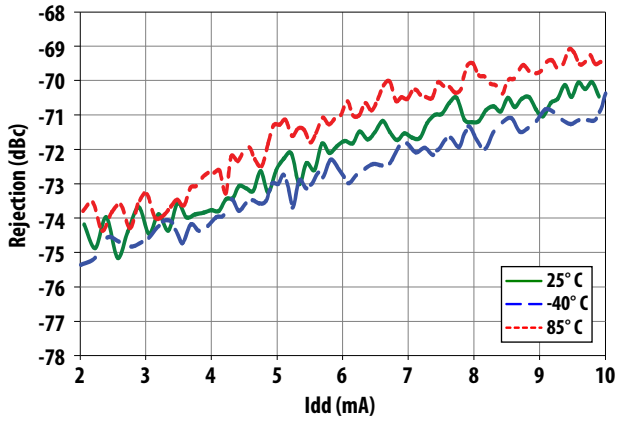

Figure 26. Rejection at 915 MHz relative to 1.575 GHz vs. Idd

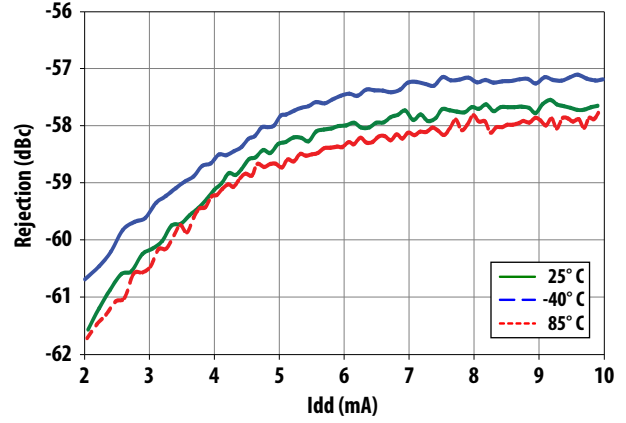

Figure 27. Rejection at 1710 MHz relative to 1.575 GHz vs. Idd

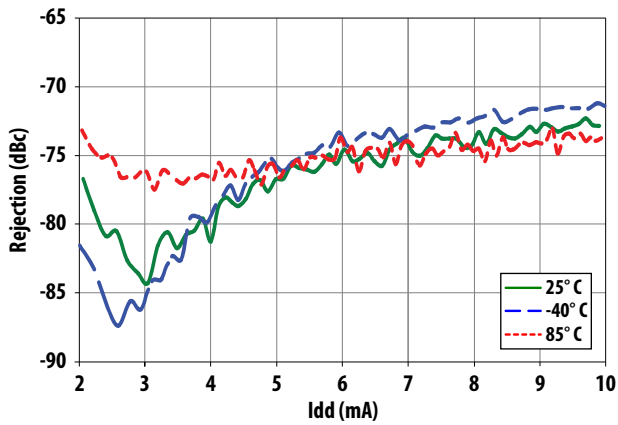

Figure 28. Rejection at 1850 MHz relative to 1.575 GHz vs. Idd

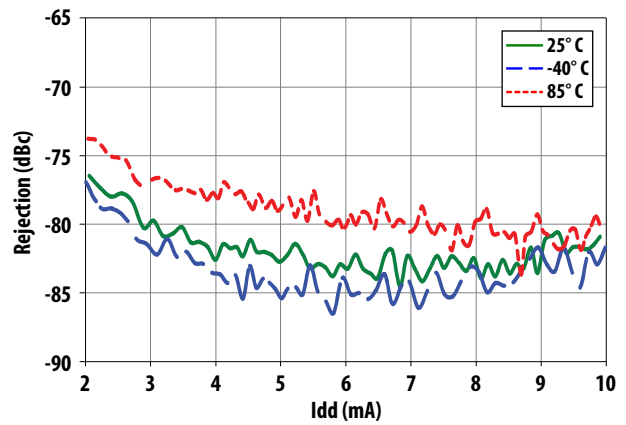

Figure 29. Rejection at 2400 MHz relative to 1.575 GHz vs. Idd

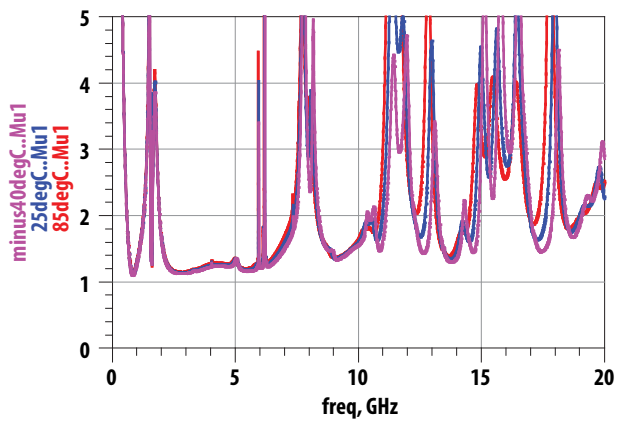

Figure 30. Edwards-Sinsky Output Stability Factor (μ)

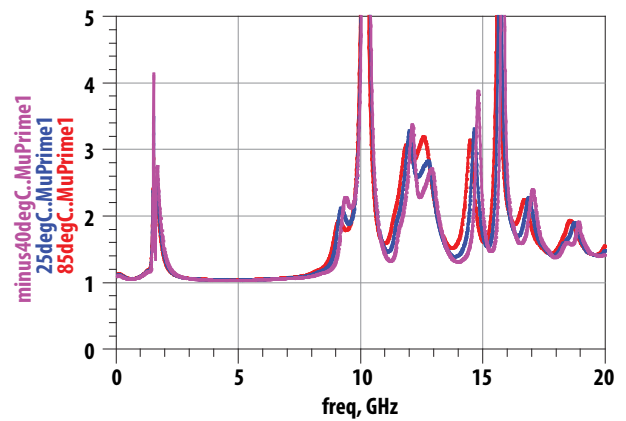

Figure 31. Edwards-Sinsky Input Stability Factor (μ')

ALM-GN002 Scattering Parameter and Measurement Reference Planes

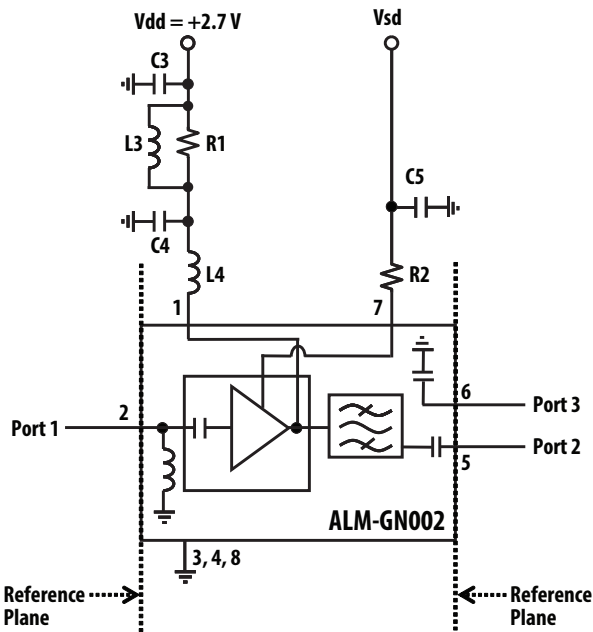

Figure 32. Scattering parameter measurement reference planes. Component values are as shown in Fig 1.

ALM-GN002 Typical Scattering Parameters at 25° C, Vdd = 2.7 V, Idd = 6.2 mA

The S- and Noise Parameters are measured using a coplanar waveguide PCB with 10 mils Rogers® RO4350. Figure 32 shows the input and output reference planes. The circuit values are as indicated in Figure 1.

Freq (GHz)	S11	S11	S12	S12	S13	S13	S21	S21	S22	S22	S23	S23	S31	S31	S32	S32	S33	S33
	Mag. (dB)	Ang. (deg)	Mag. (dB)	Ang. (deg)	Mag. (dB)	Ang. (deg)	Mag. (dB)	Ang. (deg)	Mag. (dB)	Ang. (deg)	Mag. (dB)	Ang. (deg)	Mag. (dB)	Ang. (deg)	Mag. (dB)	Ang. (deg)	Mag. (dB)	Ang. (deg)
0.05	-0.68	155.80	-88.61	-158.04	-86.05	-102.63	-87.99	66.92	-0.01	-3.16	-68.15	82.72	-86.39	-82.86	-66.85	85.97	0.00	-5.07
0.1	-0.86	134.67	-92.61	171.13	-85.46	147.59	-84.20	45.83	-0.02	-6.35	-61.40	85.20	-88.73	-143.69	-61.57	82.71	-0.01	-10.31
0.2	-0.86	101.74	-81.88	104.37	-84.25	40.25	-68.80	-17.09	-0.03	-12.42	-56.09	73.40	-78.71	-136.22	-56.23	72.91	-0.02	-20.16
0.3	-0.63	76.76	-76.62	91.94	-75.49	108.25	-64.46	-53.51	-0.09	-19.26	-53.90	64.15	-75.88	152.83	-53.87	64.37	-0.11	-30.80
0.4	-0.56	57.99	-74.41	97.36	-73.58	81.12	-64.58	-66.78	-0.11	-25.25	-52.90	57.96	-73.55	109.21	-52.93	54.77	-0.14	-39.97
0.5	-0.53	42.69	-74.45	104.60	-73.34	102.38	-63.43	-38.53	-0.14	-31.56	-53.61	48.86	-69.12	72.29	-53.94	47.81	-0.17	-49.29
0.6	-0.52	31.15	-71.97	102.53	-71.99	81.42	-58.52	-30.59	-0.16	-37.48	-56.65	45.26	-68.05	50.98	-56.74	40.35	-0.19	-57.68
0.7	-0.52	21.03	-73.16	83.31	-70.48	89.04	-53.78	-31.00	-0.19	-43.70	-67.44	47.23	-63.49	39.08	-65.93	46.82	-0.20	-66.03
0.8	-0.55	12.96	-69.99	73.83	-70.87	69.06	-50.45	-42.49	-0.21	-49.54	-61.05	-156.01	-64.64	21.40	-60.40	-155.26	-0.22	-73.53
0.824	-0.56	11.21	-74.12	85.92	-69.88	66.03	-49.60	-42.92	-0.21	-50.91	-57.32	-159.96	-64.94	18.04	-57.73	-159.76	-0.22	-75.20
0.9	-0.58	5.91	-74.18	117.24	-69.87	63.63	-47.85	-50.55	-0.25	-55.37	-51.23	-162.97	-64.87	8.10	-51.24	-163.17	-0.23	-80.51
0.915	-0.59	4.75	-73.52	74.00	-71.87	69.38	-47.45	-51.19	-0.23	-56.46	-49.79	-162.34	-64.70	6.45	-49.76	-163.17	-0.23	-81.74
1.0	-0.58	-0.68	-80.13	68.34	-71.91	43.34	-45.61	-59.95	-0.27	-59.49	-45.98	-165.38	-64.05	6.06	-45.85	-166.45	-0.27	-84.82
1.1	-0.61	-6.07	-76.05	61.29	-79.76	48.26	-43.36	-69.39	-0.30	-65.76	-42.30	-171.26	-64.80	4.23	-42.26	-171.40	-0.27	-91.26
1.2	-0.62	-11.40	-92.81	41.65	-77.80	94.27	-41.17	-80.42	-0.33	-72.88	-39.14	-178.46	-62.71	18.47	-39.14	-178.41	-0.28	-97.70
1.3	-0.59	-16.23	-82.36	-170.04	-78.79	158.91	-39.04	-93.39	-0.37	-80.54	-36.57	175.37	-59.92	33.30	-36.63	175.37	-0.28	-103.41
1.4	-0.47	-21.86	-71.20	-165.25	-74.54	170.84	-36.63	-114.53	-0.45	-91.37	-34.10	166.84	-56.25	32.78	-34.06	166.86	-0.29	-109.14
1.5	-0.48	-30.66	-66.96	-172.36	-70.59	-174.86	-34.12	-170.70	-0.79	-112.07	-31.21	153.76	-61.83	153.74	-31.24	153.67	-0.29	-114.27
1.575	-1.00	-32.06	-36.42	-135.60	-64.51	-170.66	12.89	-119.70	-18.41	-52.67	-37.65	95.38	-24.45	-148.75	-38.22	93.40	-0.29	-117.92
1.6	-1.13	-33.36	-36.47	19.35	-69.35	-125.99	12.49	29.91	-22.39	1.71	-34.05	126.69	-20.45	-36.57	-33.73	125.09	-0.29	-119.15
1.7	-2.11	-39.23	-67.81	-154.77	-67.10	175.62	-44.00	158.29	-0.33	-69.22	-34.45	170.95	-39.10	-67.35	-34.42	170.79	-0.29	-123.92
1.71	-2.13	-39.07	-66.65	-152.69	-66.51	173.46	-43.81	154.26	-0.34	-70.74	-34.17	170.15	-39.37	-69.00	-34.14	170.19	-0.29	-124.18
1.785	-2.27	-38.49	-65.25	-175.48	-64.41	179.51	-46.91	135.71	-0.39	-83.43	-31.81	162.33	-42.12	-85.47	-31.83	162.19	-0.29	-127.44
1.8	-2.27	-38.64	-63.50	-168.83	-63.45	-171.96	-48.53	133.44	-0.40	-85.42	-31.47	160.97	-42.36	-88.37	-31.44	160.89	-0.29	-128.14
1.850	-2.28	-39.37	-65.41	-168.58	-62.18	173.69	-52.80	141.01	-0.42	-90.50	-30.54	157.58	-43.50	-95.20	-30.57	157.47	-0.29	-130.27
1.9	-2.29	-40.22	-62.61	-165.97	-61.54	179.25	-57.39	167.77	-0.44	-94.29	-29.90	154.71	-44.40	-98.76	-29.90	154.87	-0.30	-132.15
1.910	-2.30	-40.47	-62.36	-172.68	-61.73	175.77	-57.05	171.63	-0.45	-95.15	-29.73	154.13	-44.62	-99.58	-29.71	154.21	-0.29	-132.54
2.0	-2.32	-42.61	-60.41	-164.87	-59.39	172.04	-53.88	-129.83	-0.46	-101.44	-28.61	149.36	-46.00	-106.30	-28.58	149.39	-0.29	-136.06
2.1	-2.37	-45.06	-58.82	-171.16	-58.40	170.41	-49.25	-118.49	-0.47	-107.34	-27.59	144.74	-46.01	-110.67	-27.58	144.73	-0.28	-139.61
2.2	-2.44	-47.73	-57.39	-178.02	-57.18	168.34	-46.78	-122.18	-0.49	-113.13	-26.64	140.30	-46.94	-116.90	-26.64	140.23	-0.28	-143.16
2.3	-2.51	-50.21	-55.52	177.15	-56.46	164.89	-45.29	-124.39	-0.50	-118.23	-25.84	136.21	-47.55	-120.54	-25.83	136.17	-0.28	-146.34
2.4	-2.60	-52.77	-54.37	175.90	-55.27	163.97	-44.15	-128.37	-0.51	-123.39	-25.06	132.06	-48.35	-121.49	-25.07	132.09	-0.27	-149.52
2.5	-2.68	-55.19	-53.74	173.90	-54.00	162.38	-43.69	-130.85	-0.52	-128.03	-24.40	128.45	-48.81	-120.39	-24.39	128.36	-0.27	-152.39
2.570	-2.73	-56.87	-53.00	173.26	-53.18	162.85	-43.27	-132.08	-0.53	-131.25	-23.97	125.78	-49.27	-117.96	-23.94	125.73	-0.26	-154.37
3.0	-3.07	-66.91	-48.97	159.56	-49.68	152.10	-42.98	-110.79	-0.58	-149.50	-21.56	110.88	-46.81	-70.88	-21.57	110.88	-0.26	-165.32
3.5	-3.32	-78.45	-48.50	134.42	-48.26	134.43	-30.44	-179.23	-0.58	-167.27	-20.66	96.49	-35.85	-171.83	-20.66	96.56	-0.24	-175.41
4.0	-3.42	-89.39	-45.12	132.08	-45.07	130.87	-38.04	177.37	-0.59	175.59	-18.68	85.04	-44.67	-148.67	-18.68	84.98	-0.22	175.73
4.5	-3.30	-99.37	-41.67	120.37	-41.95	122.01	-33.74	-108.47	-0.66	160.36	-17.25	73.25	-35.77	-97.42	-17.26	73.15	-0.23	168.40
5.0	-2.51	-106.78	-32.07	61.64	-35.00	78.40	-12.61	-142.51	-1.54	145.42	-15.41	46.87	-17.21	-135.65	-15.44	46.55	-0.48	161.99
5.5	-2.87	-116.94	-47.20	-87.40	-47.16	107.01	-19.30	98.54	-0.73	136.18	-17.20	55.22	-24.86	111.96	-17.20	55.33	-0.23	157.39
6.0	-2.68	-122.47	-50.36	-125.63	-45.83	99.14	-23.07	82.60	-0.89	125.91	-15.81	47.17	-26.98	100.67	-15.80	47.19	-0.27	150.99
6.5	-2.49	-127.93	-45.54	-146.41	-39.88	103.61	-25.91	68.64	-1.06	110.73	-14.76	36.30	-29.83	97.07	-14.72	36.58	-0.32	143.89
7.0	-2.26	-135.28	-37.39	-147.30	-37.38	93.20	-29.73	58.80	-1.91	86.87	-13.95	19.41	-30.20	95.46	-13.97	19.65	-0.36	136.67
7.5	-1.90	-145.22	-30.31	-160.89	-35.17	85.00	-22.30	105.47	-10.17	48.00	-14.77	-14.81	-27.15	98.56	-14.84	-14.44	-0.42	129.74
8.0	-1.65	-161.71	-20.07	170.54	-32.62	76.64	-15.61	-10.40	-4.28	119.61	-21.71	5.98	-26.67	60.15	-21.21	7.84	-0.25	122.51
8.5	-3.02	-172.58	-17.91	77.04	-30.30	46.36	-22.22	170.55	-2.26	110.91	-19.39	16.15	-26.83	63.09	-19.31	13.77	-0.23	115.43

ALM-GN002 Typical Scattering Parameters at 25° C, Vdd = 1.8 V, Idd = 4 mA

Freq (GHz)	S11		S12		S13		S21		S22		S23		S31		S32		S33	
	Mag. (dB)	Ang. (deg)	Mag. (dB)	Ang. (deg)	Mag. (dB)	Ang. (deg)	Mag. (dB)	Ang. (deg)	Mag. (dB)	Ang. (deg)	Mag. (dB)	Ang. (deg)	Mag. (dB)	Ang. (deg)	Mag. (dB)	Ang. (deg)	Mag. (dB)	Ang. (deg)
0.05	-0.68	155.78	-84.63	31.19	-92.06	-89.65	-93.35	-170.48	-0.01	-3.15	-66.38	85.39	-89.69	98.85	-67.95	79.94	0.00	-5.07
0.1	-0.86	134.68	-81.82	137.91	-84.26	91.20	-85.78	45.85	-0.02	-6.36	-61.82	87.69	-98.33	132.92	-61.29	80.38	-0.01	-10.33
0.2	-0.87	101.79	-85.15	130.87	-87.03	102.85	-71.43	-13.76	-0.03	-12.42	-56.31	72.24	-86.05	106.02	-56.21	72.32	-0.02	-20.16
0.3	-0.64	76.84	-81.49	148.78	-77.55	121.26	-66.94	-53.84	-0.09	-19.25	-53.90	63.42	-81.42	114.83	-53.79	62.72	-0.11	-30.79
0.4	-0.56	58.09	-76.63	121.37	-74.87	137.11	-69.62	-55.29	-0.11	-25.25	-53.17	55.94	-72.92	104.02	-53.13	56.15	-0.14	-39.97
0.5	-0.51	42.76	-74.30	85.33	-69.99	85.60	-67.65	-36.01	-0.14	-31.55	-53.91	50.21	-70.28	81.37	-53.69	49.27	-0.17	-49.28
0.6	-0.49	31.18	-71.28	83.41	-70.33	77.04	-61.70	-18.74	-0.16	-37.46	-56.31	40.20	-67.74	54.33	-56.80	41.03	-0.19	-57.66
0.7	-0.48	21.01	-70.40	75.56	-70.76	81.10	-56.98	-26.76	-0.19	-43.69	-67.32	37.02	-66.02	60.04	-67.91	48.38	-0.20	-66.02
0.8	-0.49	12.84	-69.71	75.51	-73.09	85.77	-53.50	-33.27	-0.21	-49.53	-59.76	-160.71	-65.40	31.78	-60.45	-158.90	-0.22	-73.50
0.824	-0.49	11.06	-69.57	77.73	-74.18	56.99	-53.01	-35.59	-0.21	-50.90	-57.74	-161.32	-64.36	33.16	-57.67	-159.77	-0.22	-75.19
0.9	-0.51	5.70	-72.71	61.22	-73.53	69.02	-50.65	-43.15	-0.25	-55.35	-51.04	-163.20	-64.15	16.86	-51.17	-162.44	-0.23	-80.50
0.915	-0.51	4.52	-77.92	63.78	-74.22	66.43	-50.25	-45.94	-0.23	-56.45	-50.32	-163.01	-65.45	19.04	-50.01	-163.86	-0.23	-81.72
1.0	-0.50	-1.01	-76.54	69.98	-73.59	69.01	-48.24	-51.95	-0.27	-59.49	-45.94	-166.78	-64.30	22.48	-45.99	-165.68	-0.27	-84.80
1.1	-0.52	-6.53	-75.84	59.59	-75.08	60.70	-46.00	-63.07	-0.30	-65.74	-42.30	-171.63	-64.71	24.16	-42.16	-171.56	-0.27	-91.23
1.2	-0.53	-11.96	-85.09	145.21	-79.05	92.63	-43.72	-74.38	-0.33	-72.86	-39.11	-177.88	-62.42	29.00	-39.10	-178.11	-0.28	-97.69
1.3	-0.50	-16.87	-77.18	-139.84	-84.16	138.35	-41.21	-86.89	-0.36	-80.50	-36.61	175.19	-58.74	41.35	-36.58	175.31	-0.28	-103.37
1.4	-0.38	-22.56	-69.40	-154.16	-77.76	-176.50	-38.27	-109.33	-0.44	-91.34	-34.07	167.32	-54.67	38.33	-34.06	167.13	-0.28	-109.12
1.5	-0.51	-31.64	-66.00	-175.53	-71.66	174.74	-35.72	-175.94	-0.78	-112.05	-31.21	153.64	-62.67	34.73	-31.24	153.71	-0.29	-114.23
1.575	-0.90	-32.45	-35.61	-146.11	-64.52	173.76	10.88	-121.34	-27.49	-135.32	-36.78	97.05	-26.57	-149.82	-37.33	95.58	-0.29	-117.90
1.6	-1.03	-33.60	-36.00	7.91	-69.33	-136.23	10.36	27.08	-16.84	55.03	-34.22	119.20	-22.51	-39.26	-33.86	117.76	-0.29	-119.13
1.7	-1.76	-37.86	-67.47	-154.95	-65.42	-177.85	-48.15	153.84	-0.33	-69.20	-34.46	170.80	-41.24	-71.74	-34.44	170.73	-0.29	-123.88
1.71	-1.77	-37.82	-67.08	-159.96	-65.11	176.79	-48.06	151.04	-0.34	-70.71	-34.16	170.14	-41.53	-73.29	-34.16	170.40	-0.29	-124.16
1.785	-1.80	-38.76	-66.02	-166.60	-63.27	175.27	-51.34	137.09	-0.39	-83.40	-31.82	162.28	-43.97	-85.84	-31.82	162.18	-0.29	-127.39
1.8	-1.80	-39.14	-64.15	-162.47	-62.93	-178.82	-52.64	138.83	-0.40	-85.39	-31.45	161.05	-44.33	-87.77	-31.47	161.06	-0.29	-128.11
1.850	-1.82	-40.47	-62.22	-165.59	-62.80	176.55	-57.47	151.76	-0.42	-90.47	-30.52	157.45	-45.50	-92.38	-30.55	157.51	-0.29	-130.25
1.9	-1.84	-41.71	-63.55	-166.70	-61.75	179.24	-60.96	-164.89	-0.44	-94.26	-29.87	154.78	-46.11	-96.36	-29.89	154.87	-0.29	-132.11
1.910	-1.85	-42.04	-61.21	-176.16	-61.75	168.66	-60.20	-162.58	-0.44	-95.11	-29.72	154.21	-46.12	-96.60	-29.75	154.18	-0.29	-132.52
2.0	-1.90	-44.74	-60.33	-172.04	-59.11	173.63	-54.78	-114.94	-0.45	-101.39	-28.61	149.24	-47.23	-101.55	-28.60	149.50	-0.28	-136.04
2.1	-1.97	-47.63	-57.71	-178.33	-58.76	171.36	-50.75	-113.10	-0.47	-107.29	-27.56	144.84	-47.27	-107.45	-27.58	144.86	-0.28	-139.58
2.2	-2.06	-50.70	-57.12	-177.77	-57.55	169.07	-48.29	-115.81	-0.48	-113.09	-26.64	140.30	-48.11	-110.04	-26.63	140.27	-0.28	-143.11
2.3	-2.15	-53.54	-55.89	177.88	-56.06	163.90	-46.69	-119.13	-0.49	-118.20	-25.84	136.16	-48.12	-112.86	-25.84	136.21	-0.28	-146.30
2.4	-2.26	-56.44	-55.05	176.61	-55.22	162.33	-45.64	-123.27	-0.51	-123.34	-25.08	132.15	-48.44	-115.75	-25.07	132.14	-0.27	-149.47
2.5	-2.36	-59.18	-53.44	171.30	-54.38	157.16	-45.05	-126.63	-0.52	-127.99	-24.40	128.49	-48.72	-115.89	-24.40	128.34	-0.26	-152.34
2.570	-2.43	-61.09	-53.43	168.47	-53.55	158.47	-44.58	-127.69	-0.52	-131.23	-23.96	125.87	-49.00	-114.96	-23.95	125.84	-0.26	-154.33
3.0	-2.89	-72.33	-49.42	157.01	-50.13	148.32	-43.46	-111.88	-0.57	-149.46	-21.57	110.95	-46.98	-85.29	-21.56	110.89	-0.25	-165.28
3.5	-3.32	-84.82	-48.64	135.67	-48.28	130.34	-32.17	-178.69	-0.57	-167.23	-20.66	96.58	-37.14	-170.46	-20.66	96.63	-0.24	-175.36
4.0	-3.59	-96.20	-45.68	129.79	-45.49	127.48	-38.59	-179.51	-0.59	175.62	-18.67	85.04	-43.48	-151.54	-18.68	85.04	-0.21	175.77
4.5	-3.64	-106.17	-42.50	118.00	-42.66	119.02	-34.66	-118.97	-0.66	160.40	-17.24	73.21	-36.68	-110.69	-17.26	73.15	-0.22	168.46
5.0	-3.10	-113.58	-33.37	59.30	-36.12	76.97	-14.08	-153.03	-1.58	145.88	-15.55	45.72	-18.52	-146.62	-15.58	45.37	-0.50	162.19
5.5	-3.46	-122.19	-49.19	-88.55	-46.98	106.42	-21.22	93.08	-0.73	136.14	-17.17	55.21	-26.43	109.22	-17.17	55.36	-0.22	157.45
6.0	-3.36	-127.24	-50.25	-133.73	-45.91	98.60	-24.94	76.23	-0.89	125.91	-15.79	47.20	-28.36	96.94	-15.79	47.23	-0.27	151.07
6.5	-3.21	-132.55	-44.61	-148.01	-40.25	103.61	-28.00	60.59	-1.06	110.76	-14.76	36.46	-30.58	97.89	-14.72	36.64	-0.31	143.97
7.0	-3.03	-140.33	-36.93	-150.85	-37.51	93.13	-32.33	47.42	-1.91	86.89	-13.96	19.53	-30.12	95.91	-13.97	19.74	-0.36	136.77
7.5	-2.83	-152.43	-29.49	-154.73	-35.97	79.04	-25.15	70.39	-10.09	48.77	-14.82	-14.86	-26.92	86.36	-14.89	-14.33	-0.41	129.85
8.0	-4.02	-169.61	-18.40	149.05	-33.22	77.26	-19.51	-100.30	-4.98	123.79	-21.65	6.47	-29.29	61.25	-21.12	5.80	-0.24	122.62
8.5	-4.51	-172.65	-18.55	70.34	-31.14	45.73	-18.50	119.41	-2.04	109.26	-19.17	15.15	-26.62	57.96	-19.19	13.40	-0.22	115.54

ALM-GN002 Typical Noise Parameters at 25° C, Freq = 1.575 GHz, Vdd = 2.7 V, Idd = 6.2 mA

Freq (GHz)	Fmin (dB)	GAMMA OPT		
		Mag	Ang	Rn/50
1.565	0.82	0.669	27.0	0.4380
1.575	0.86	0.600	30.9	0.4514
1.585	0.84	0.662	28.2	0.4356
1.598	0.83	0.670	26.1	0.4456
1.602	0.81	0.689	25.8	0.4492
1.606	0.82	0.675	26.5	0.4434

ALM-GN002 Typical Noise Parameters at 25° C, Freq = 1.575 GHz, Vdd = 1.8 V, Idd = 4 mA

Freq (GHz)	Fmin (dB)	GAMMA OPT		
		Mag	Ang	Rn/50
1.565	0.95	0.708	25.4	0.5946
1.575	0.95	0.709	25.7	0.6028
1.585	0.99	0.708	26.6	0.5820
1.598	0.98	0.707	26.6	0.6020
1.602	0.92	0.723	26.5	0.6082
1.606	0.95	0.718	26.4	0.6070

Note:

- The exceptional noise figure performance of the ALM-GN002 is due to its highly optimized design. In this regard, the Fmin of the ALM-GN002 shown above is locked down by the internal input pre-match. This allows the use of relatively inexpensive chip inductors for external matching.

Part Number Ordering Information

Part Number	Qty	Container
ALM-GN002-BLKG	100	Antistatic bag
ALM-GN002-TR1G	3000	7" Reel

Package Dimensions

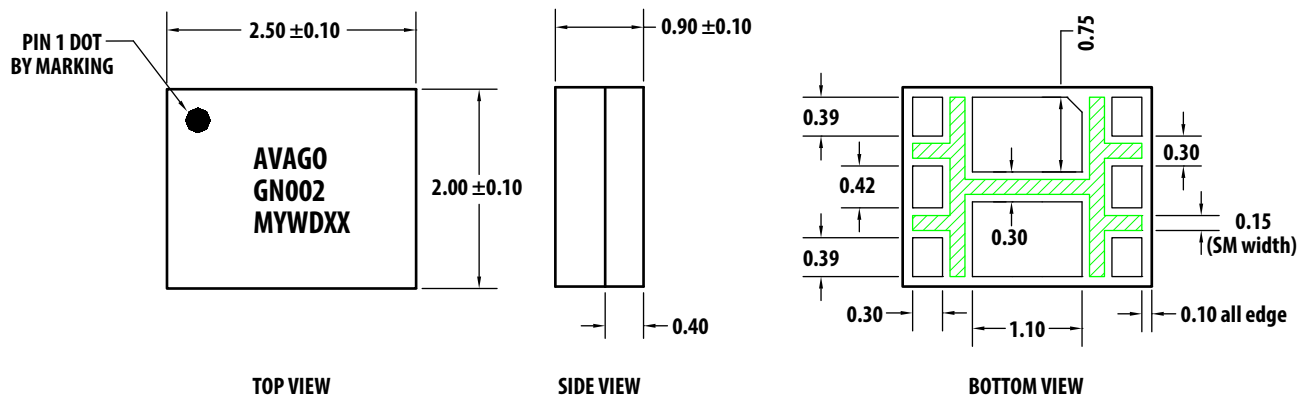

Notes:

- All dimensions are in millimeters.
- Dimensions are inclusive of plating.
- Dimensions are exclusive of mold flash and metal burr.
- GN002 = device code, M = manufacturing location (M = Malaysia), Y = Year of Manufacture, W = Work Week, D = Date Code, XX = Last 4 Digits of Lot Number.

PCB Land Patterns and Stencil Design

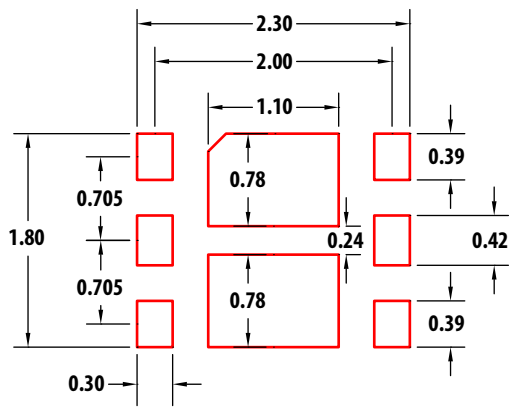

LAND PATTERN

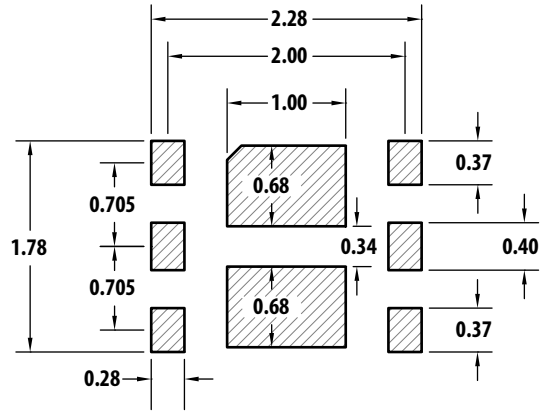

STENCIL OPENING

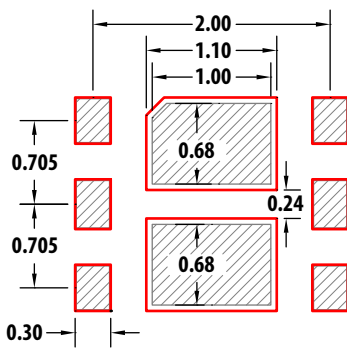

COMBINATION OF LAND PATTERN & STENCIL OPENING

Notes:

1. All dimensions are in millimeters.
2. Recommended 4 mil stencil thickness.

Device Orientation

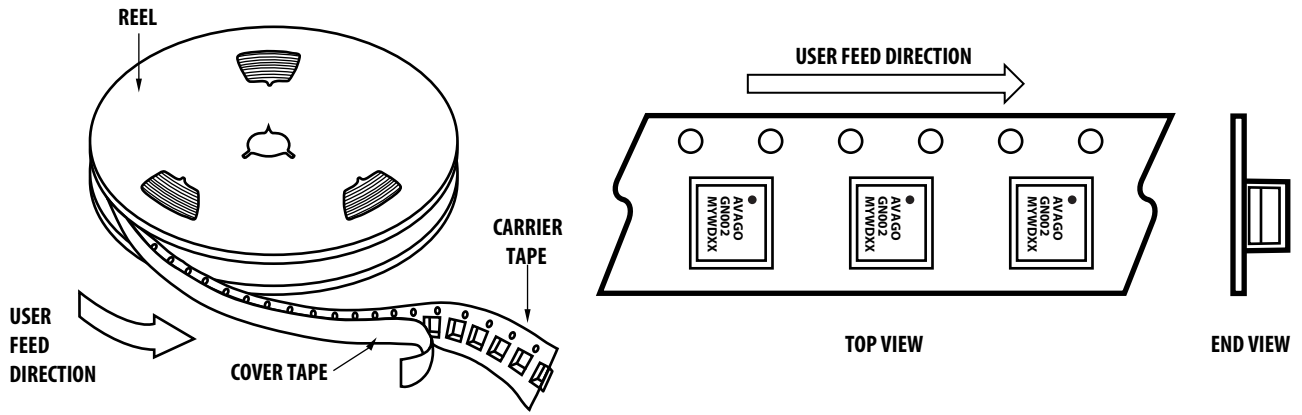

Tape Dimensions

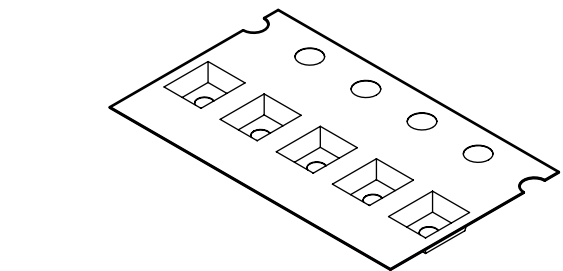
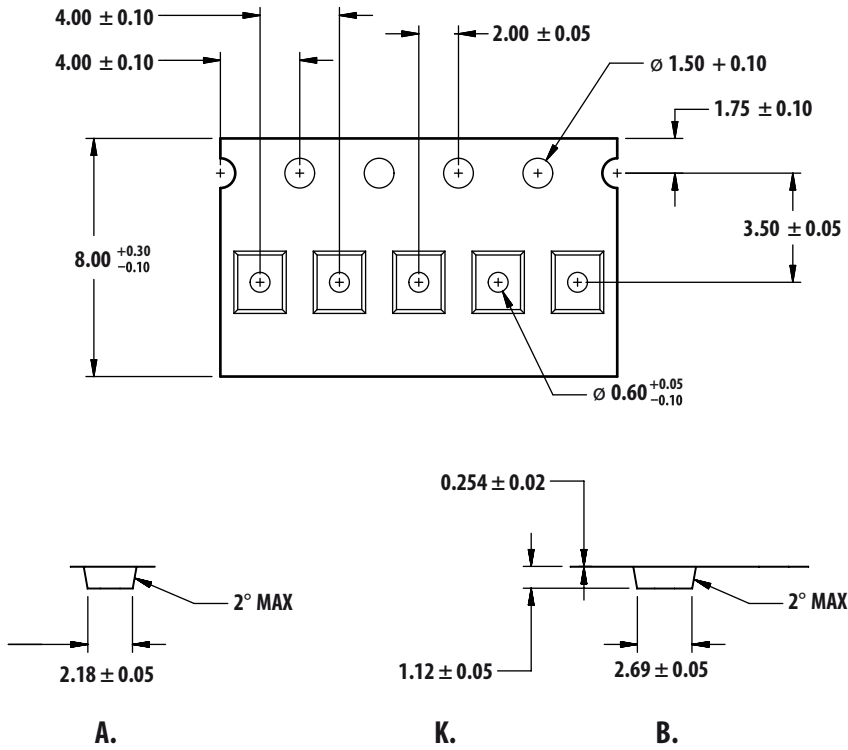

All dimensions are in millimeters

Reel Dimensions (7" reel)

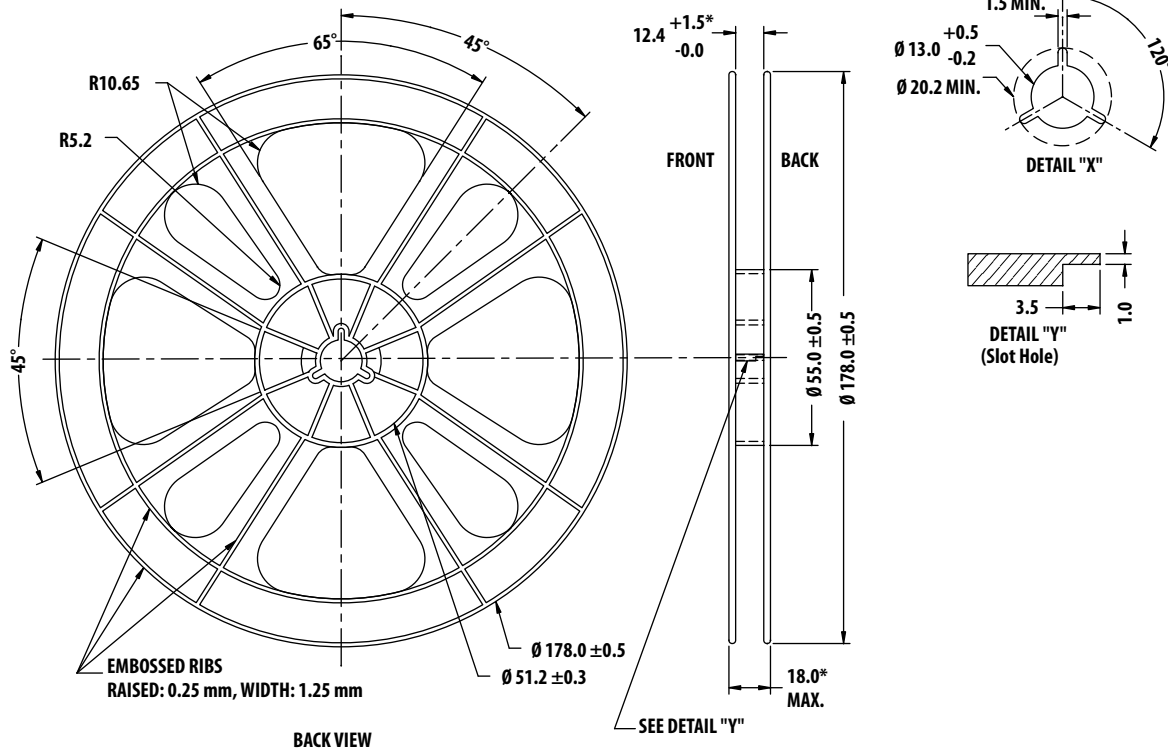
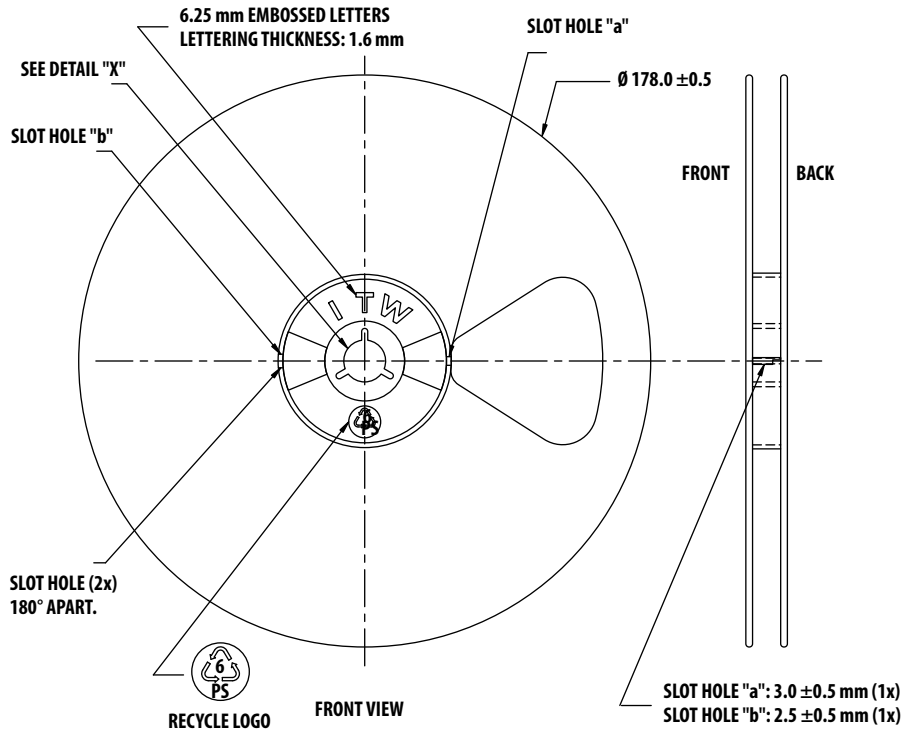

For product information and a complete list of distributors, please go to our web site: www.avagotech.com

Avago, Avago Technologies, and the A logo are trademarks of Avago Technologies in the United States and other countries. Data subject to change. Copyright © 2005-2014 Avago Technologies. All rights reserved. AV02-4550EN - June 20, 2014

