

USER'S MANUAL

SYSDRIVE MX SERIES

Multi-function Compact Inverter

Introduction

Thank you for choosing the general-purpose Inverter 3G3MX. This User's Manual (hereinafter called "this manual") describes the parameter setting methods required for installation/wiring and operation of the 3G3MX model, as well as troubleshooting and inspection methods.

- This manual should be delivered to the actual end user of the product.
- After reading this manual, keep it handy for future reference.
- This manual describes the specifications and functions of the product as well as the relations between them. You should assume that anything not described in this manual is not possible with the product.
- Intended readers
This manual is intended for:
Those with knowledge of the workings of electricity (qualified electric engineers or the equivalent), and also in charge of:
 - Introducing the control equipment
 - Designing the control system
 - Installing and/or connecting the control equipment
 - Field management

Read and Understand this Manual

Please read and understand this manual before using the product. Please consult your OMRON representative if you have any questions or comments.

Warranty and Limitations of Liability

WARRANTY
<p>OMRON's exclusive warranty is that the products are free from defects in materials and workmanship for a period of one year (or other period if specified) from date of sale by OMRON.</p> <p>OMRON MAKES NO WARRANTY OR REPRESENTATION, EXPRESS OR IMPLIED, REGARDING NON-INFRINGEMENT, MERCHANTABILITY, OR FITNESS FOR PARTICULAR PURPOSE OF THE PRODUCTS. ANY BUYER OR USER ACKNOWLEDGES THAT THE BUYER OR USER ALONE HAS DETERMINED THAT THE PRODUCTS WILL SUITABLY MEET THE REQUIREMENTS OF THEIR INTENDED USE. OMRON DISCLAIMS ALL OTHER WARRANTIES, EXPRESS OR IMPLIED.</p>

LIMITATIONS OF LIABILITY
<p>OMRON SHALL NOT BE RESPONSIBLE FOR SPECIAL, INDIRECT, OR CONSEQUENTIAL DAMAGES, LOSS OF PROFITS OR COMMERCIAL LOSS IN ANY WAY CONNECTED WITH THE PRODUCTS, WHETHER SUCH CLAIM IS BASED ON CONTRACT, WARRANTY, NEGLIGENCE, OR STRICT LIABILITY.</p> <p>In no event shall the responsibility of OMRON for any act exceed the individual price of the product on which liability is asserted.</p> <p>IN NO EVENT SHALL OMRON BE RESPONSIBLE FOR WARRANTY, REPAIR, OR OTHER CLAIMS REGARDING THE PRODUCTS UNLESS OMRON'S ANALYSIS CONFIRMS THAT THE PRODUCTS WERE PROPERLY HANDLED, STORED, INSTALLED, AND MAINTAINED AND NOT SUBJECT TO CONTAMINATION, ABUSE, MISUSE, OR INAPPROPRIATE MODIFICATION OR REPAIR.</p>

Application Considerations

SUITABILITY FOR USE

OMRON shall not be responsible for conformity with any standards, codes, or regulations that apply to the combination of products in the customer's application or use of the products.

At the customer's request, OMRON will provide applicable third party certification documents identifying ratings and limitations of use that apply to the products. This information by itself is not sufficient for a complete determination of the suitability of the products in combination with the end product, machine, system, or other application or use.

The following are some examples of applications for which particular attention must be given. This is not intended to be an exhaustive list of all possible uses of the products, nor is it intended to imply that the uses listed may be suitable for the products:

- Outdoor use, uses involving potential chemical contamination or electrical interference, or conditions or uses not described in this manual.
- Nuclear energy control systems, combustion systems, railroad systems, aviation systems, medical equipment, amusement machines, vehicles, safety equipment, and installations subject to separate industry or government regulations.
- Systems, machines, and equipment that could present a risk to life or property.

Please know and observe all prohibitions of use applicable to the products.

NEVER USE THE PRODUCTS FOR AN APPLICATION INVOLVING SERIOUS RISK TO LIFE OR PROPERTY WITHOUT ENSURING THAT THE SYSTEM AS A WHOLE HAS BEEN DESIGNED TO ADDRESS THE RISKS, AND THAT THE OMRON PRODUCTS ARE PROPERLY RATED AND INSTALLED FOR THE INTENDED USE WITHIN THE OVERALL EQUIPMENT OR SYSTEM.

PROGRAMMABLE PRODUCTS

OMRON shall not be responsible for the user's programming of a programmable product, or any consequence thereof.

Disclaimers

CHANGE IN SPECIFICATIONS

Product specifications and accessories may be changed at any time based on improvements and other reasons.

It is our practice to change model numbers when published ratings or features are changed, or when significant construction changes are made. However, some specifications of the products may be changed without any notice. When in doubt, special model numbers may be assigned to fix or establish key specifications for your application on your request. Please consult with your OMRON representative at any time to confirm actual specifications of purchased products.

DIMENSIONS AND WEIGHTS

Dimensions and weights are nominal and are not to be used for manufacturing purposes, even when tolerances are shown.

PERFORMANCE DATA

Performance data given in this manual is provided as a guide for the user in determining suitability and does not constitute a warranty. It may represent the result of OMRON's test conditions, and the users must correlate it to actual application requirements. Actual performance is subject to the OMRON Warranty and Limitations of Liability.

ERRORS AND OMISSIONS

The information in this manual has been carefully checked and is believed to be accurate; however, no responsibility is assumed for clerical, typographical, or proofreading errors, or omissions.



Safety Precautions

■ Indications and Meanings of Safety Information









In this user's manual, the following precautions and signal words are used to provide information to ensure the safe use of the 3G3MX Inverter.









The information provided here is vital to safety. Strictly observe the precautions provided.

■ Meanings of Signal Words

 WARNING	Indicates an imminently hazardous situation which, if not avoided, is likely to result in serious injury or may result in death. Additionally there may be severe property damage.
 CAUTION	Indicates a potentially hazardous situation which, if not avoided, may result in minor or moderate injury or in property damage.

■ Alert Symbols in this Document

 WARNING	
	Turn off the power supply and implement wiring correctly. Not doing so may result in a serious injury due to an electric shock.
	Wiring work must be carried out only by qualified personnel. Not doing so may result in a serious injury due to an electric shock.
	Do not put on or take off the Digital Operator control circuit terminal block terminal block cover while the input power is being supplied. Doing so may result in a serious injury due to an electric shock.
	Be sure to ground the unit. Not doing so may result in a serious injury due to an electric shock or fire. (200-V class: type-D grounding, 400-V class: type-C grounding)
	Do not remove the terminal block cover during the power supply and 5 minutes after the power shutoff. Doing so may result in a serious injury due to an electric shock.
	Do not operate the Digital Operator or switches with wet hands. Doing so may result in a serious injury due to an electric shock.
	Do not change wiring, mode change switches, optional devices or replace cooling fans while power is being supplied. Doing so may result in a serious injury due to an electric shock.

 CAUTION	
	<p>Do not connect resistors to the terminals (+1, P/+2, N/-) directly. Doing so might result in a small-scale fire, heat generation or damage to the unit.</p>
	<p>Install a stop motion device to ensure safety. Not doing so might result in a minor injury. (A holding brake is not a stop motion device designed to ensure safety.)</p>
	<p>Be sure to use a specified type of braking resistor/regenerative braking unit. In case of a braking resistor, install a thermal relay that monitors the temperature of the resistor. Not doing so might result in a moderate burn due to the heat generated in the braking resistor/regenerative braking unit. Configure a sequence that enables the Inverter power to turn off when unusual overheating is detected in the braking resistor/regenerative braking unit.</p>
	<p>The Inverter has high voltage parts inside which, if short-circuited, might cause damage to itself or other property. Place covers on the openings or take other precautions to make sure that no metal objects such as cutting bits or lead wire scraps go inside when installing and wiring.</p>
	<p>Do not touch the Inverter fins, braking resistors and the motor, which become too hot during the power supply and for some time after the power shutoff. Doing so may result in a burn.</p>
	<p>Take safety precautions such as setting up a molded-case circuit breaker (MCCB) that matches the Inverter capacity on the power supply side. Not doing so might result in damage to property due to the short circuit of the load.</p>
	<p>Do not dismantle, repair or modify this product. Doing so may result in an injury.</p>

Precautions for Safe Use

■ Installation and Storage

Do not store or use the product in the following places.

- Locations subject to direct sunlight.
- Locations subject to ambient temperature exceeding the specifications.
- Locations subject to relative humidity exceeding the specifications.
- Locations subject to condensation due to severe temperature fluctuations.
- Locations subject to corrosive or flammable gases.
- Locations subject to exposure to combustibles.
- Locations subject to dust (especially iron dust) or salts.
- Locations subject to exposure to water, oil, or chemicals.
- Locations subject to shock or vibration.

■ Transporting, Installation, and Wiring

- Do not drop or apply strong impact on the product. Doing so may result in damaged parts or malfunction.
- Do not hold by the terminal block cover, but hold by the fins during transportation.
- Do not connect an AC power supply voltage to the control input/output terminals. Doing so may result in damage to the product.
- Be sure to tighten the screws on the terminal block securely.
Wiring work must be done after installing the unit body.
- Do not connect any load other than a three-phase inductive motor to the U, V, and W output terminals.
- Take sufficient shielding measures when using the product in the following locations. Not doing so may result in damage to the product.
 - Locations subject to static electricity or other forms of noise.
 - Locations subject to strong magnetic fields.
 - Locations close to power lines.

■ Operation and Adjustment

- Be sure to confirm the permissible range of motors and machines before operation because the Inverter speed can be changed easily from low to high.
- Provide a separate holding brake if necessary.

■ Maintenance and Inspection

- Be sure to confirm safety before conducting maintenance, inspection or parts replacement.

Precautions for Correct Use

■Installation

- Mount the product vertically on a wall with the product's longer sides upright.
The material of the wall has to be nonflammable such as a metal plate.

■Main Circuit Power Supply

- Confirm that the rated input voltage of the Inverter is the same as AC power supply voltage.

■Error Retry Function

- Do not come close to the machine when using the error retry function because the machine may abruptly start when stopped by an alarm.
- Be sure to confirm the RUN signal is turned off before resetting the alarm because the machine may abruptly start.

■Operation Stop Command

- Provide a separate emergency stop switch because the STOP key on the Digital Operator is valid only when function settings are performed.
- When checking a signal during the power supply and the voltage is erroneously applied to the control input terminals, the motor may start abruptly. Be sure to confirm safety before checking a signal.

■Product Disposal

- Comply with the local ordinance and regulations when disposing of the product.

Warning Labels

Warning labels are located on the Inverter as shown in the following illustration.
Be sure to follow the instructions.

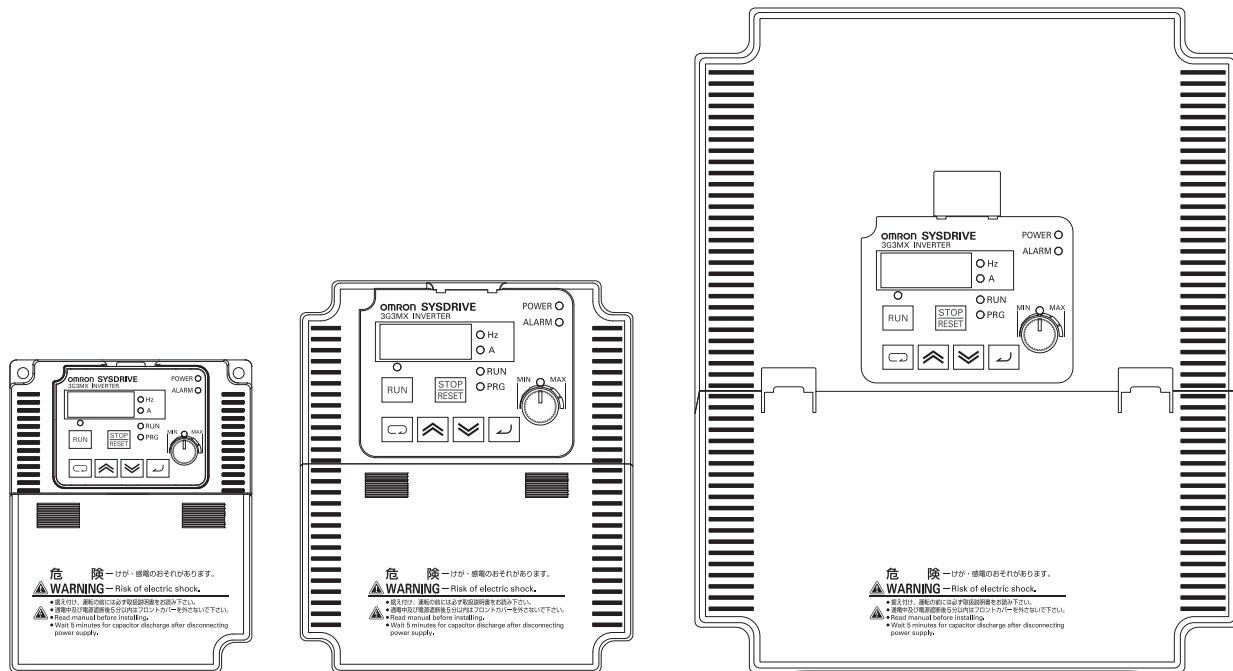

Warning Description

危険 - けが・感電のおそれがあります。

WARNING - Risk of electric shock.

- 据え付け、運転の前には必ず取扱説明書をお読み下さい。
- 通電中及び電源遮断後5分以内はフロントカバーを外さないで下さい。
- Read manual before installing.
- Wait 5 minutes for capacitor discharge after disconnecting power supply.

Checking Before Unpacking

■Checking the Product

On delivery, be sure to check that the delivered product is the Inverter 3G3MX model that you ordered.

Should you find any problems with the product, immediately contact your nearest local sales representative or OMRON sales office.

●Checking the Nameplate

Inverter model	→	OMRON INVERTER 3G3MX-A2002
Input specifications	→	KW/(HP) : 0.2/(1/4) INPUT: 50Hz, 60Hz V 1Ph A
Output specifications	→	INPUT: 50Hz, 60Hz 200-240 V 3Ph 2.0A OUTPUT: 0.5-400Hz 200-240 V 3Ph 1.6A
		LOT NO: ***** Date: ****
		S/N: ***** NE*****-**
		OMRON Corporation MADE IN JAPAN

●Checking the Model

3 G 3 M X - A 2 0 0 2

Maximum applicable motor capacity

002	0.2 kW
004	0.4 kW
007	0.75 kW
015	1.5 kW
022	2.2 kW
037	3.7 kW
055	5.5 kW
075	7.5 kW

Voltage class

2	3-phase 200 V AC (200-V class)
E	1/3-phase 200 V AC (200-V class)
4	3-phase 400 V AC (400-V class)

Enclosure rating

A	Panel-mounting (IP10 min.) or closed wall-mounting models
---	---

■Checking the Accessories

Note that this manual is the only accessory included with the 3G3MX model. Mounting screws and other necessary parts must be provided by the user.

Revision History

■ A manual revision code appears as a suffix to the catalog number located at the lower left of the front and back covers.

Cat. No. I559-E1-02

↑
Revision code

Revision code	Revision date	Changes and revision pages
01	December 2007	First printing
02	December 2008	Revisions made to correct errors 8, 1-1 2-3, 2-4, 2-11, 2-12, 2-14, 2-16 to 2-22, 2-24, 3-31, 3-33 4-14, 4-19, 4-25, 4-26, 4-53, 4-57, 4-60, 4-67, 4-71 to 77, 4-79 to 4-90 6-2, 7-1, 7-2, 7-4, 7-6 to 7-12, 7-17, 7-22, 7-29, 7-31, 7-32 App-13, App-15

About This Manual

This User's Manual is compiled chapter by chapter for user's convenience as follows. Understanding the following configuration ensures more effective use of the product.

	Overview
Chapter 1 Overview	Describes features and names of parts.
Chapter 2 Design	Provides external dimensions, installation dimensions, peripheral device design/selection instructions, and other information necessary for design.
Chapter 3 Operation	Describes names of parts, the Inverter's operations, including how to use the keys on the Digital Operator, and the monitor function.
Chapter 4 Functions	Describes the functions of the Inverter.
Chapter 5 Maintenance Operations	Describes the causes and their countermeasures if the Inverter fails, including the solutions to possible troubles (troubleshooting).
Chapter 6 Inspection and Maintenance	Describes items for periodical inspection and/or maintenance for the Inverter.
Chapter 7 Specifications	Provides Inverter specifications, as well as the specifications and dimensions of peripheral devices.
Appendix	Describes the summarized parameter settings as a reference for users who have used this Inverter and understood the functions.

Introduction.....	1
Read and Understand this Manual.....	2
Safety Precautions	5
Precautions for Safe Use.....	7
Precautions for Correct Use	8
Checking Before Unpacking	10
Revision History.....	11
About This Manual.....	12
Chapter 1 Overview	
1-1 Functions	1-1
1-2 Appearance and Names of Parts.....	1-3
Chapter 2 Design	
2-1 Installation.....	2-1
2-2 Removing and Mounting Each Part.....	2-5
2-3 Wiring.....	2-10
Chapter 3 Operation	
3-1 Test Run Procedure.....	3-2
3-2 Test Run Operation	3-3
3-3 Part Names and Descriptions of the Digital Operator.....	3-8
3-4 Operation Procedure (Example: Factory Default).....	3-10
3-5 Keys.....	3-16
3-6 Parameter Transition	3-17
3-7 Parameter List	3-19
Chapter 4 Functions	
4-1 Monitor Mode.....	4-1
4-2 Function Mode.....	4-5
Chapter 5 Maintenance Operations	
5-1 Special Display List.....	5-1
5-2 Troubleshooting.....	5-5
Chapter 6 Inspection and Maintenance	
6-1 Inspection and Maintenance.....	6-1
6-2 Storage	6-7
Chapter 7 Specifications	
7-1 Standard Specification List	7-1

Contents

7-2	Measurement Method of Output Voltage	7-5
7-3	Connection Example	7-6
7-4	Dimensional Drawing	7-8
7-5	Options.....	7-14

Appendix

Appendix-1	Parameter List	App-1
Appendix-2	Product Life Curve.....	App-17

Index

Chapter 1

Overview

1-1	Functions	1-1
1-2	Appearance and Names of Parts	1-3

1-1 Functions

3G3MX Inverter Models

Rated voltage	Enclosure rating	Max. applicable motor output	Model
3-phase 200 V AC	IP20 (Complies with JEM1030)	0.2 kW	3G3MX-A2002
		0.4 kW	3G3MX-A2004
		0.75 kW	3G3MX-A2007
		1.5 Kw	3G3MX-A2015
		2.2 kW	3G3MX-A2022
		3.7 kW	3G3MX-A2037
		5.5 kW	3G3MX-A2055
		7.5 kW	3G3MX-A2075
3-phase 400 V AC		0.4 kW	3G3MX-A4004
		0.75 kW	3G3MX-A4007
		1.5 kW	3G3MX-A4015
		2.2 kW	3G3MX-A4022
		3.7 kW	3G3MX-A4037
		5.5 kW	3G3MX-A4055
		7.5 kW	3G3MX-A4075
1/3-phase 200 V AC		0.2 kW	3G3MX-AE002
		0.4 kW	3G3MX-AE004
		0.75 kW	3G3MX-AE007
		1.5 kW	3G3MX-AE015
		2.2 kW	3G3MX-AE022

International Standards Models (EC Directives and UL/cUL Standards)

The 3G3MX Inverter meets the EC Directives and UL/cUL standard requirements for worldwide use.

Classification		Applicable standard
EC Directives	EMC Directive	EN61800-3: 2004
	Low-voltage Directive	EN61800-5-1: 2003
UL/cUL Standards		UL508C

Easy-to-use General-purpose Inverter with Vector Control Functions

■Advanced Functions

High Starting Torque

With its vector control, the 3G3MX Series has achieved high starting torque in excess of 200% at 1 Hz.

Trip Suppression

This Inverter features two trip suppression functions: "Overcurrent suppression function" to suppress overcurrent trip during acceleration, and "Overvoltage LAD stop function" to suppress overvoltage trip during deceleration. Therefore, the 3G3MX Series provides tough operational capabilities regardless of the severe time setting of acceleration and deceleration.

Equipped with Communication Function

ModBus-RTU communication allows you to perform network operation at low cost.

■Easy Operation

Adoption of Removable Control Circuit Terminal Block

Adoption of a removable control circuit terminal block substantially reduces onerous task of wiring during the maintenance work.

Removable Digital Operator

The 3G3MX Series features a removable Digital Operator as a standard. By removing the Digital Operator and connecting with the dedicated cable, you can operate the Inverter at hand and mount it on the surface of the control panel.

Side-by-side Mounting

Side-by-side mounting contributes to space saving.

Built-in Braking Circuit

All models are equipped with a braking transistor, which is capable of handling applications with rapid acceleration and stop.

1-2 Appearance and Names of Parts

You can open and close the terminal block cover by hand, without using any tool. When the terminal block cover is removed as illustrated below, you can operate the mode selector and perform wiring to the control circuit terminal block, the main circuit terminal block, and the relay output terminal block.

3G3MX-A2002 to A2007, 3G3MX-AE002 to AE004

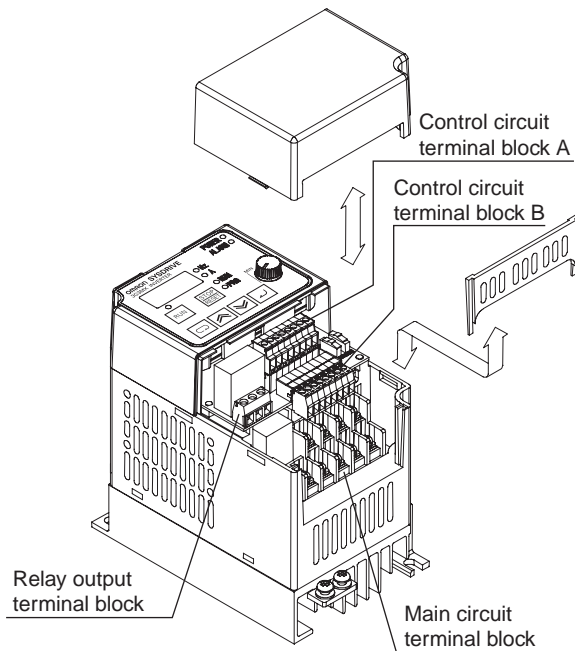
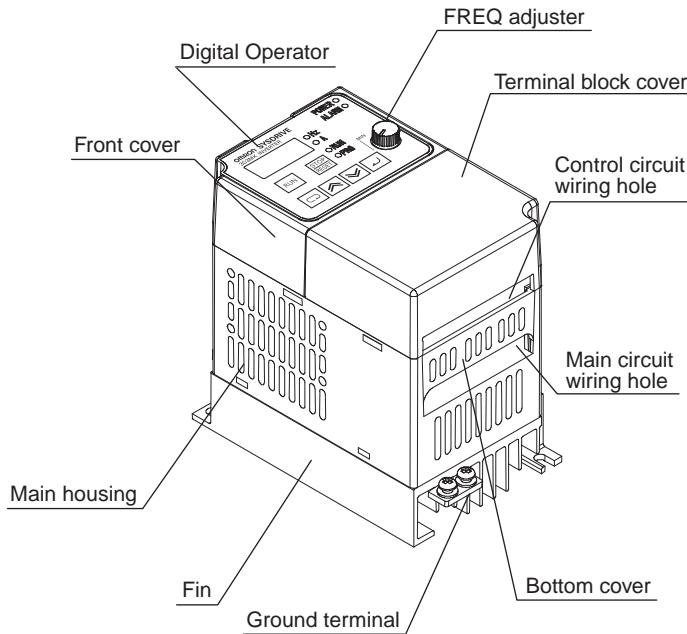

**3G3MX-A2015 to A2037, 3G3MX-A4004 to A4037,
3G3MX-AE007 to AE022**

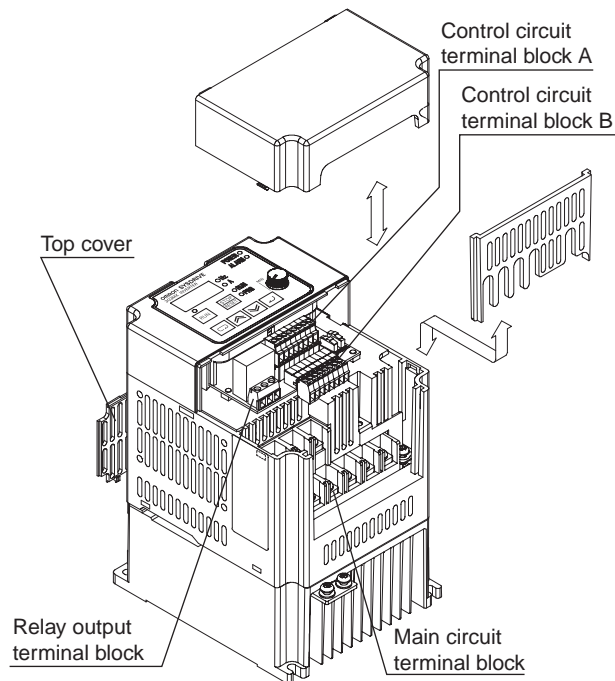
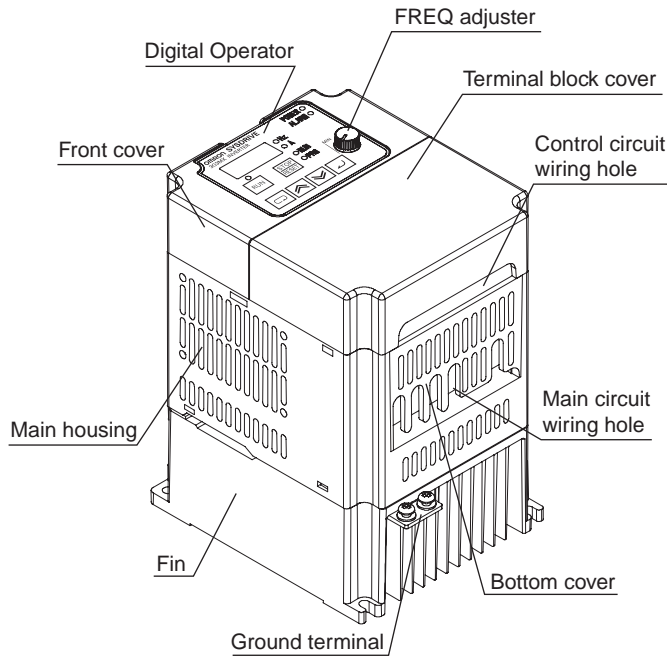

Note: The top cover is intended for maintenance use only. Do not remove the top cover.

3G3MX-A2055 to A2075, 3G3MX-A4055 to A4075

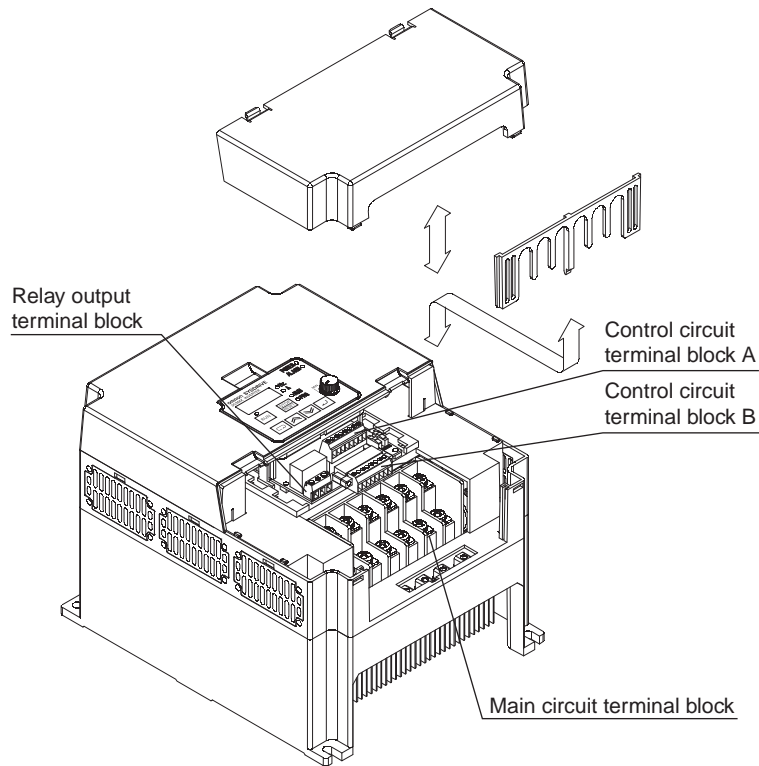
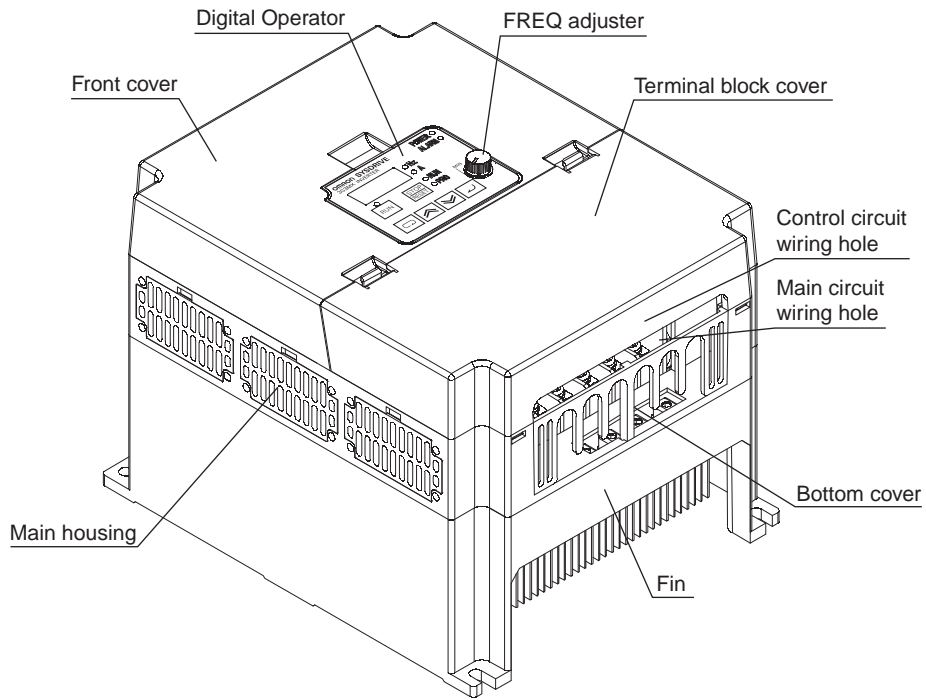

Names of Parts (When the Digital Operator is Removed)

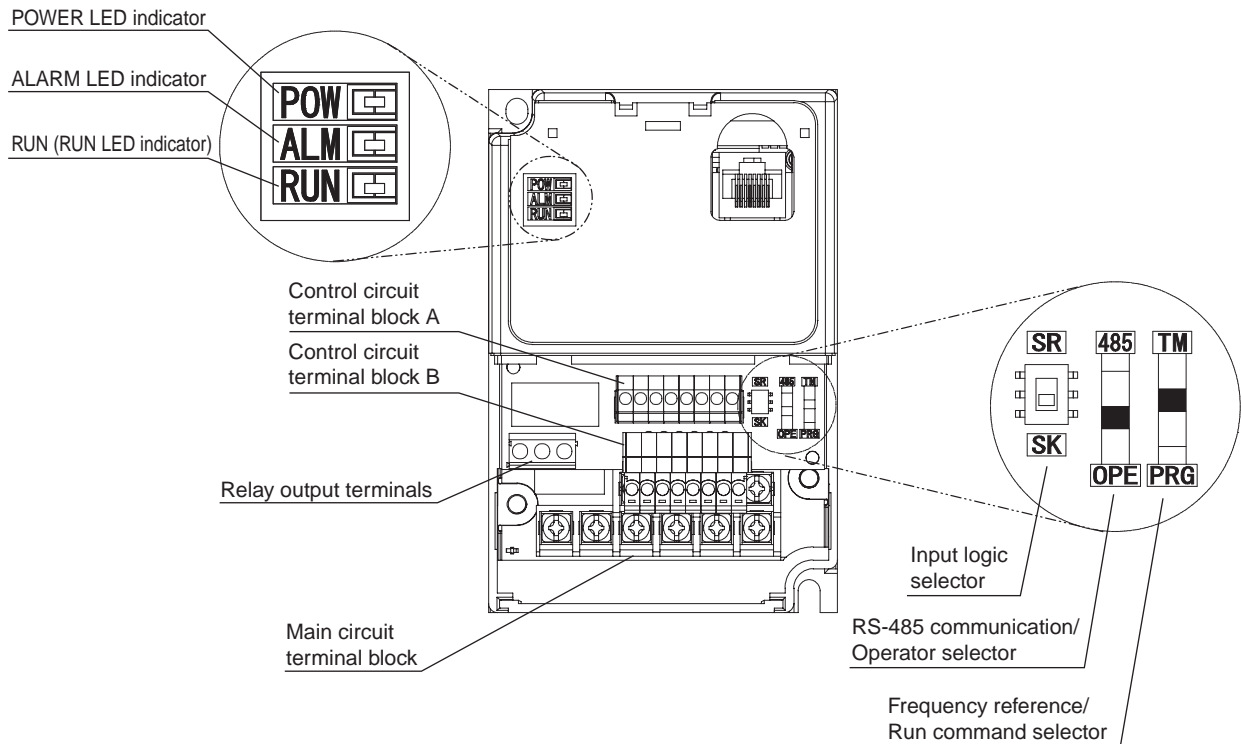
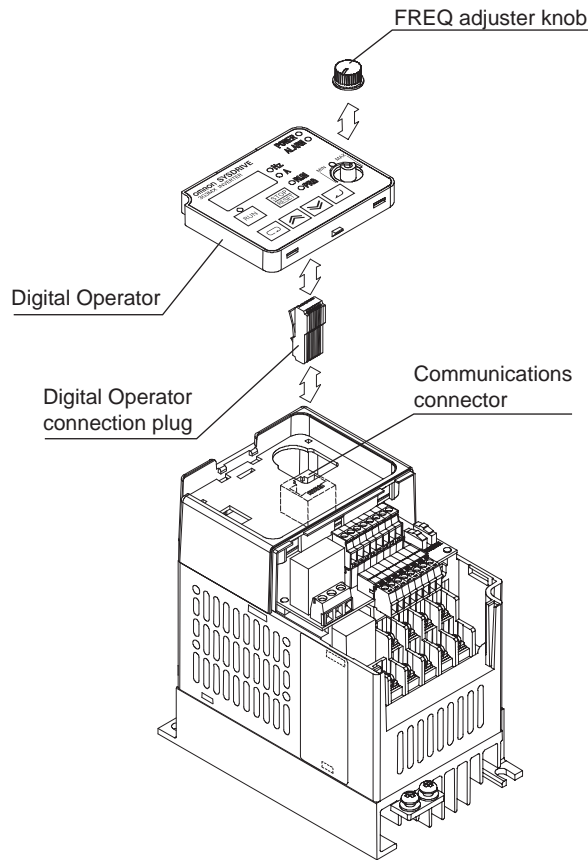

Chapter 2

Design





2-1	Installation	2-1
2-2	Removing and Mounting Each Part.....	2-5
2-3	Wiring.....	2-10

2-1 Installation





2

Design

WARNING

	Turn off the power supply and implement wiring correctly. Not doing so may result in a serious injury due to an electric shock.
	Wiring work must be carried out only by qualified personnel. Not doing so may result in a serious injury due to an electric shock.
	Do not put on or take off the Digital Operator control circuit terminal block terminal block cover while the input power is being supplied. Doing so may result in a serious injury due to an electric shock.
	Be sure to ground the unit. Not doing so may result in a serious injury due to an electric shock or fire. (200-V class: type-D grounding, 400-V class: type-C grounding)

CAUTION

	Do not connect resistors to the terminals (+1, P/+2, N/-) directly. Doing so might result in a small-scale fire, heat generation or damage to the unit.
	Install a stop motion device to ensure safety. Not doing so might result in a minor injury. (A holding brake is not a stop motion device designed to ensure safety.)
	Be sure to use a specified type of braking resistor/regenerative braking unit. In case of a braking resistor, install a thermal relay that monitors the temperature of the resistor. Not doing so might result in a moderate burn due to the heat generated in the braking resistor/regenerative braking unit. Configure a sequence that enables the Inverter power to turn off when unusual overheating is detected in the braking resistor/regenerative braking unit.
	The Inverter has high voltage parts inside which, if short-circuited, might cause damage to itself or other property. Place covers on the openings or take other precautions to make sure that no metal objects such as cutting bits or lead wire scraps go inside when installing and wiring.

Safety Information

■ Installation and Storage

Do not store or use the product in the following places.

- Locations subject to direct sunlight.
- Locations subject to ambient temperature exceeding the specifications.
- Locations subject to relative humidity exceeding the specifications.
- Locations subject to condensation due to severe temperature fluctuations.
- Locations subject to corrosive or flammable gases.
- Locations subject to exposure to combustibles.
- Locations subject to dust (especially iron dust) or salts.
- Locations subject to exposure to water, oil, or chemicals.
- Locations subject to shock or vibration.

■ Transporting, Installation, and Wiring

- Do not drop or apply strong impact on the product. Doing so may result in damaged parts or malfunction.
- Do not hold by the terminal block cover, but hold by the fins during transportation.
- Do not connect an AC power supply voltage to the control input/output terminals. Doing so may result in damage to the product.
- Be sure to tighten the screws on the terminal block securely.
Wiring work must be done after installing the unit body.
- Do not connect any load other than a three-phase inductive motor to the U, V, and W output terminals.
- Take sufficient shielding measures when using the product in the following locations. Not doing so may result in damage to the product.
 - Locations subject to static electricity or other forms of noise.
 - Locations subject to strong magnetic fields.
 - Locations close to power lines.

Precautions for Use

■ Installation

- Mount the product vertically on a wall with the product's longer sides upright. The material of the wall has to be nonflammable such as a metal plate.

2

Design

Model

3G3MX-A2002
A2004
A2007
AE002
AE004

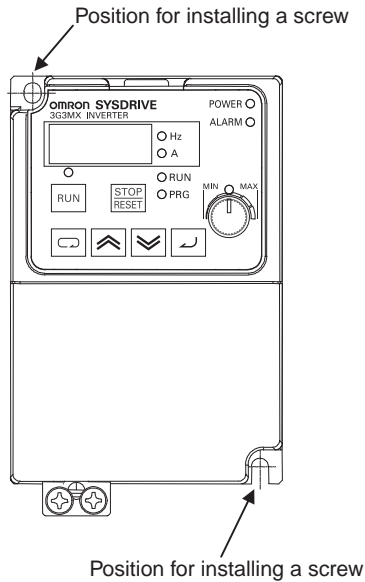

Screw size for installation: M5

Model

3G3MX-A2015
A2022
A2037
A4004
A4007
A4015
A4022
A4037
AE007
AE015
AE022

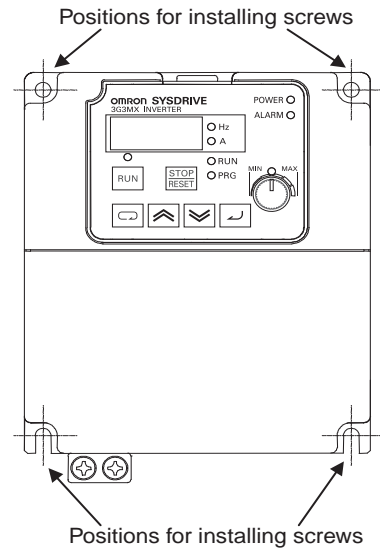

Screw size for installation: M5

Model

3G3MX-A2055
-A2075
-A4055
-A4075

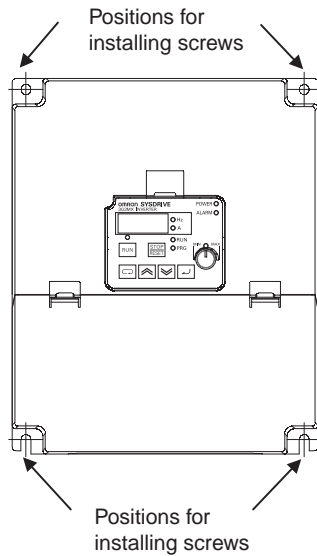

Screw size for installation: M6

■ Main Circuit Power Supply

- Confirm that the rated input voltage of the Inverter matches the AC power supply voltage.

■ Installation Environment

- Increased ambient temperatures will shorten the life of the Inverter.
- Keep the Inverter away from heating elements (such as a braking resistor, DC reactor, etc.).
If the Inverter is installed in a control panel, keep the ambient temperature within the range of the specifications, taking dimensions and ventilation into consideration.

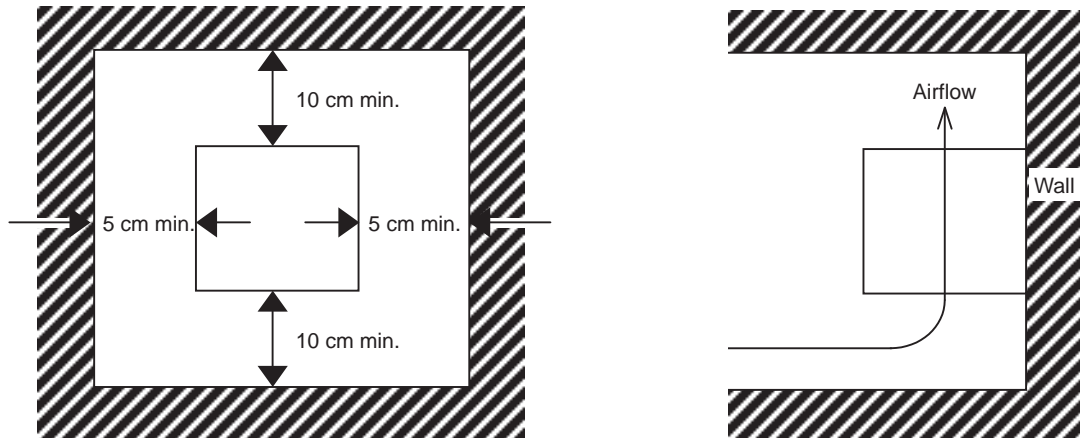

- If the ambient temperature is from 40°C to 50°C, the carrier frequency should be reduced and the Inverter capacity should be increased.
- Before installing the Inverter, cover all the ventilation openings to shield them from foreign objects.
After completing the installation process, be sure to remove the covers from the Inverter before operation.

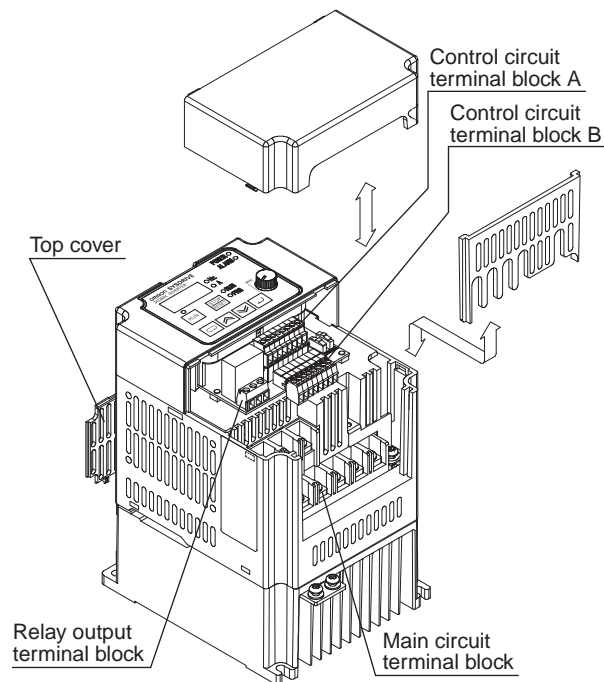

2-2 Removing and Mounting Each Part

2

Removing and Mounting the Terminal Block Cover

■ 3G3MX-A2002 to A2037, 3G3MX-A4004 to A4037, 3G3MX-AE002 to AE022

(1) Removing the Terminal Block Cover

Press the one side (1) of tab A on the terminal block cover, and use the opposite side of tab A as a supporting point to disconnect tab B on the same side of the pressed tab A.

Then, press the opposite side of tab A and disconnect the other tab B.

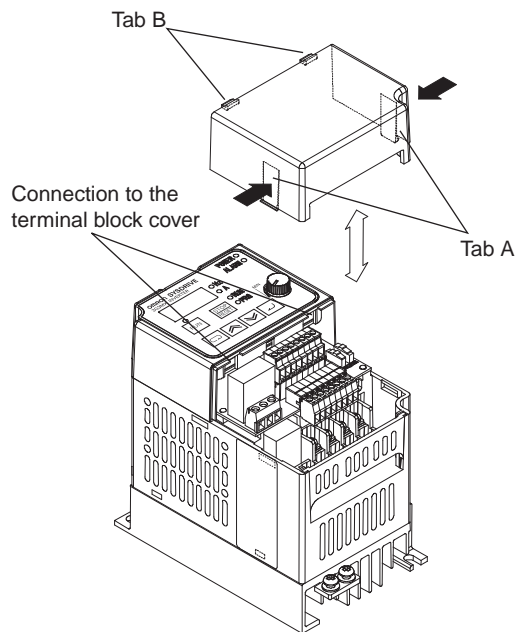
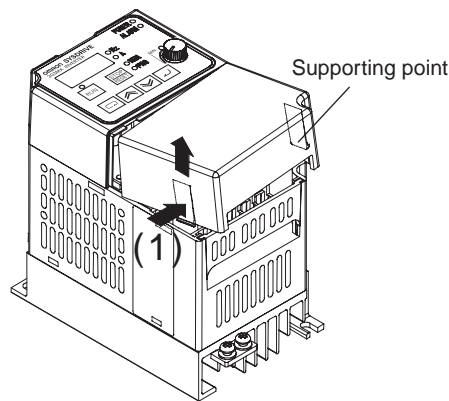

(2) Mounting the Terminal Cover

Push down both sides of A and B simultaneously from the upper side of the terminal cover until it clicks into place.

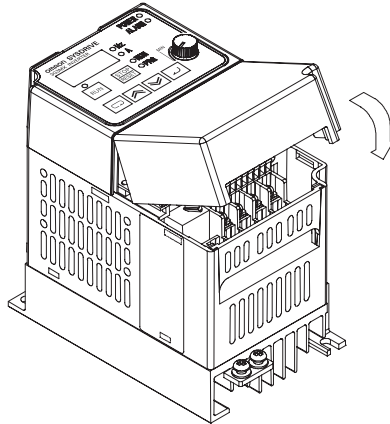

■ 3G3MX-A2055 to A2075, 3G3MX-A4055 to A4075

(1) Removing the Terminal Block Cover

- Press the two A tabs on the terminal block cover toward the direction of the arrow in the figure below, and unlock the front cover to disconnect.
- Use the B tabs on the terminal block cover and the fitting part with the main unit housing as supporting points, and lift up the terminal block cover.

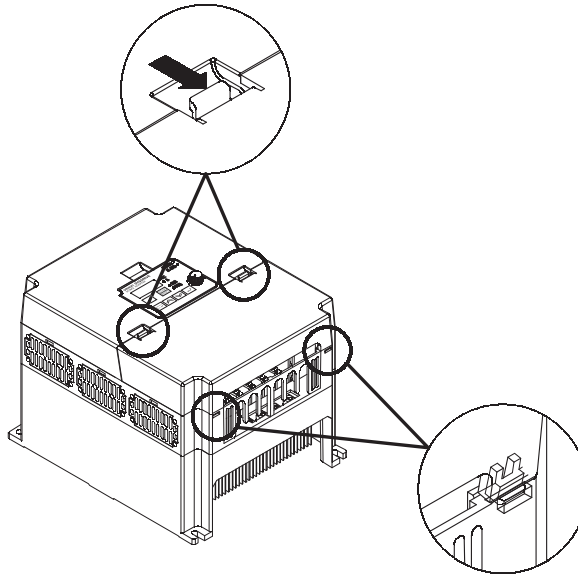

(2) Mounting the Terminal Block Cover

Fit the B tabs on the terminal block cover into the main unit housing, and push down the cover from the upper side until the two A tabs click into place.

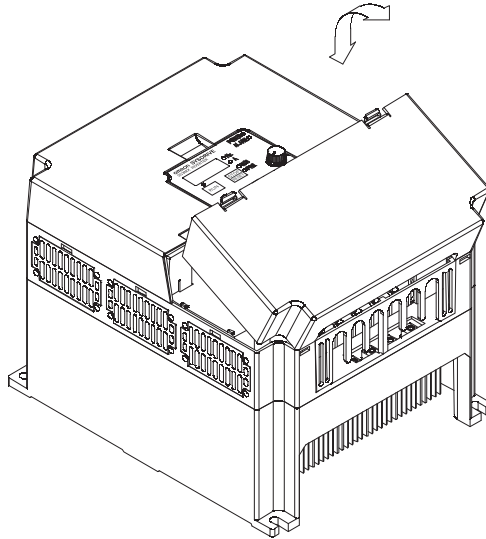

Removing and Mounting the Digital Operator

■ Removing the Digital Operator

Pressing the upper tab on the Digital Operator, pull it up to the Inverter's front (upper direction in the figure below).

*Supplemental Information

When using the communications connector, remove the Digital Operator connection plug. It can be removed by pulling it up to the Inverter's front (upper direction in the figure below).

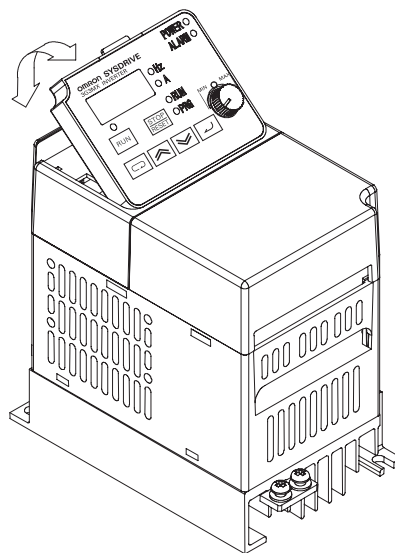

■ Mounting the Digital Operator

Place the bottom of the Digital Operator into the open space in the front cover, and push down the upper side of the Digital Operator.

*Supplemental Information

Before mounting the Digital Operator, be sure to mount the Digital Operator connection plug. To mount the Digital Operator connection plug, push its tab into the communication connector until it clicks into place.

Removing and Mounting the Control Circuit Terminal Blocks

■ Removing the Control Circuit Terminal Blocks

Step (1)

Pull up control circuit terminal block A (Terminals SC, S1 to S6) off the Inverter's front (upper direction in the figure below) to remove.

Step (2)

Loosen the screws on the both sides of the control circuit terminal block B (Terminals FS, FV, FI, FC, AM, PC, P2, P1) and pull it up toward the Inverter's bottom (right lower direction in the figure below) to remove.

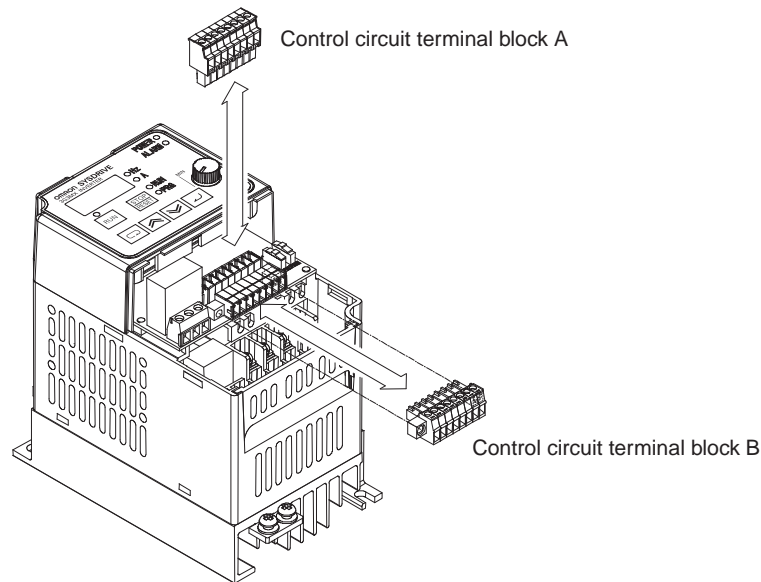

■ Mounting the Control Circuit Terminal Blocks

Step (1)

Push control circuit terminal block A (Terminals SC, S1 to S6) down securely on the Inverter's front (upper direction in the figure on the previous page).

Step (2)

Push control circuit terminal block B (Terminals FS, FV, FI, FC, AM, PC, P2, P1) down securely from the Inverter's bottom (right lower direction in the figure on the previous page). Furthermore, securely tighten the screws on the both sides of the terminal block. Loosened screws may result in the terminal block falling off.

Note: To remove/mount the control circuit terminal blocks, you need a screwdriver with a tip size of +No.0, and a shaft diameter of 2.4 mm or less.

2-3 Wiring

Wiring to the Power Supply and Motor

Open the terminal block cover and wire the main circuit terminal blocks.

■3G3MX-A2002 to A2007, 3G3MX-AE002 to AE004

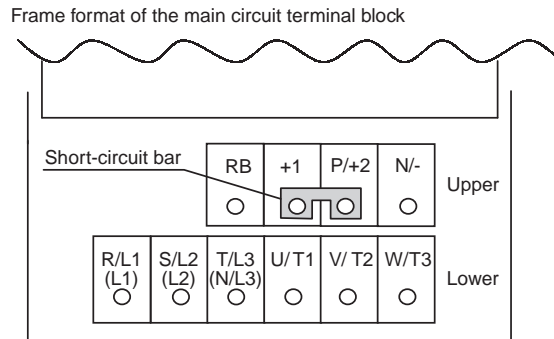
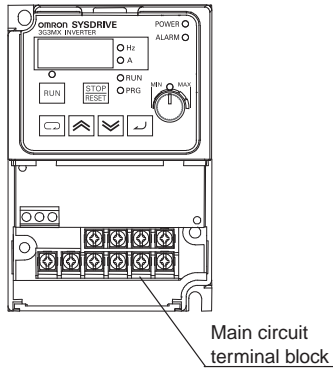

* Terminal symbols for 3G3MX-AE□□□ are indicated in parentheses ().

■3G3MX-A2015 to A2037, 3G3MX-A4004 to A4037, 3G3MX-AE007 to AE022

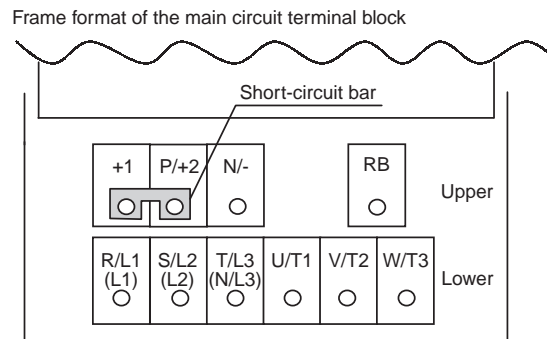
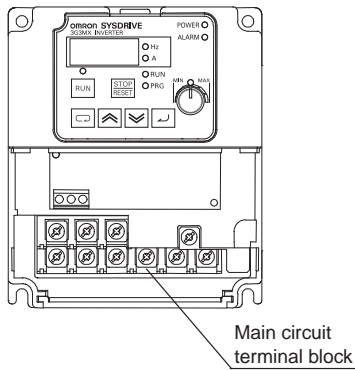

* Terminal symbols for 3G3MX-AE□□□ are indicated in parentheses ().

■3G3MX-A2055 to A2075, 3G3MX-A4055 to A4075

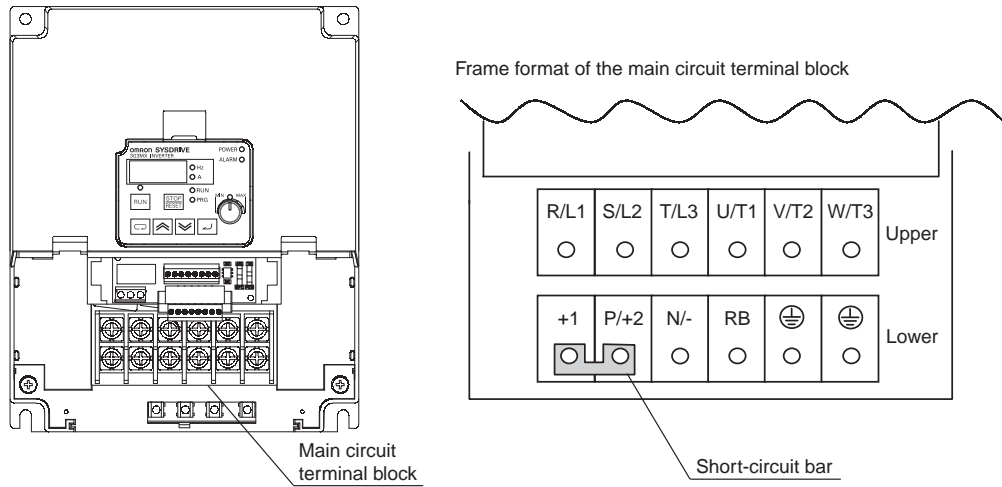

Standard Connection Diagram

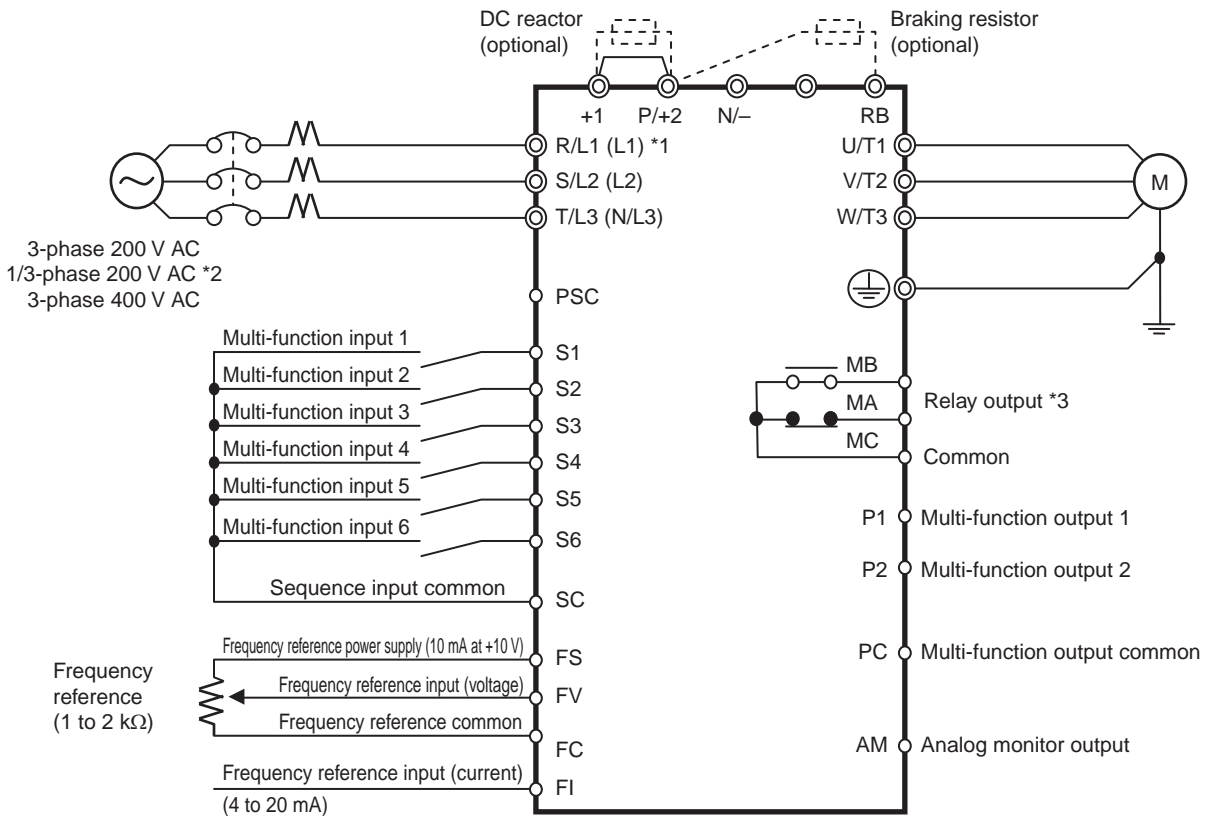

*1. Terminal symbols for 3G3MX-AE□□□ are indicated in parentheses ().
 *2. Connect a single-phase 200-V AC input to terminals L1 and N/L3.
 *3. By factory default, MA is set to NC contact, and MB to NO contact in the relay output (MA, MB) selection (C036).

■Connecting to the Power Supply and Motor

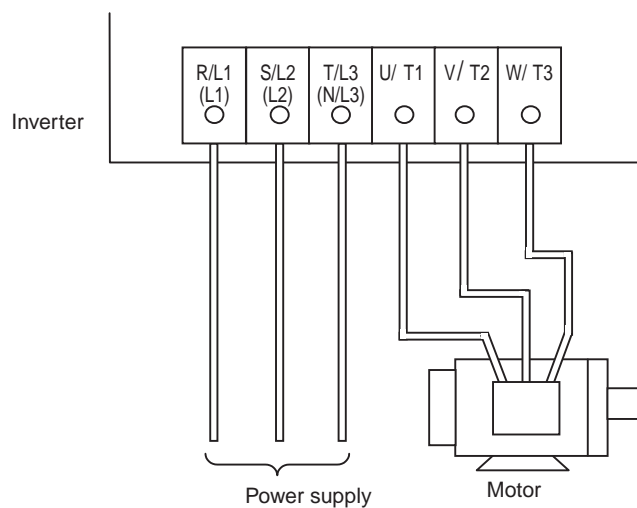

* Terminal symbols for 3G3MX-AE□□□ are indicated in parentheses ().

- Do not connect the power supply other than to R/L1, S/L2, or T/L3.
- Do not remove the short-circuit bar between P/+2 and +1, except when a DC reactor is connected.

Note 1: Install an earth leakage breaker on the power supply input side.

(Select an earth leakage breaker having a larger high-frequency sensed current and avoid unnecessary operations.)

If the wiring between the Inverter and the motor is too long (longer than 10 m), the thermal relay may malfunction due to harmonics. Install an AC reactor on the Inverter output side, or use a current sensor instead of the thermal relay.

Note 2: Connect securely to the ground as specified (type-D grounding for 200-V class, and type-C grounding for 400-V class). Do not share the grounding electrode with other strong electrical devices.

Example of incorrect grounding

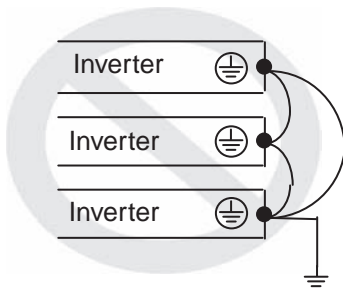

Example of correct grounding

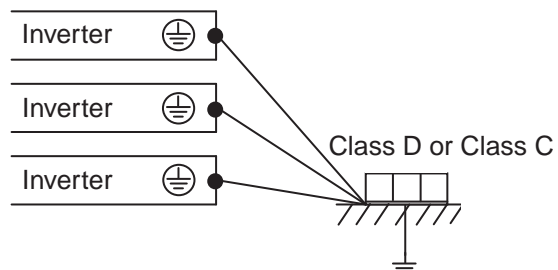

Wiring the Control Circuit Terminals and Relay Output Terminals

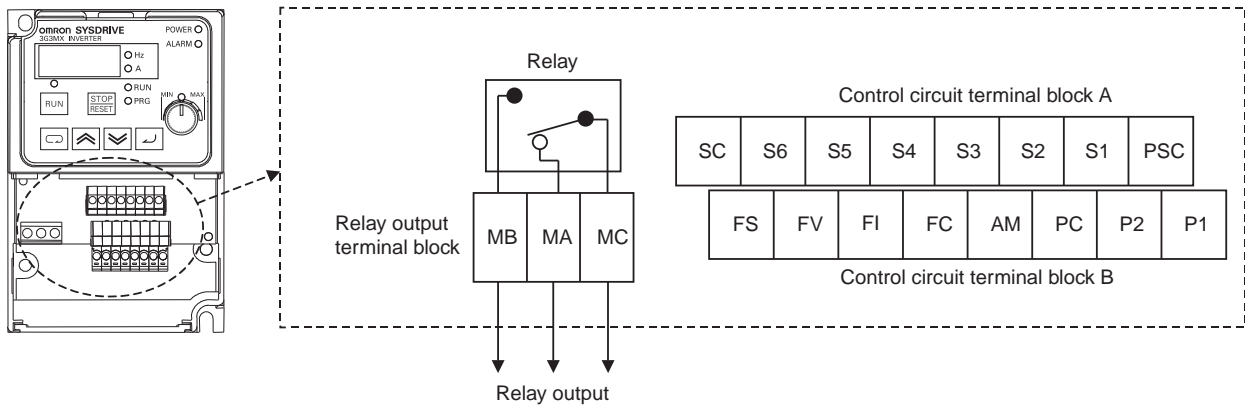

Wiring Example of the Control Circuit Terminal Block (Sink Logic)

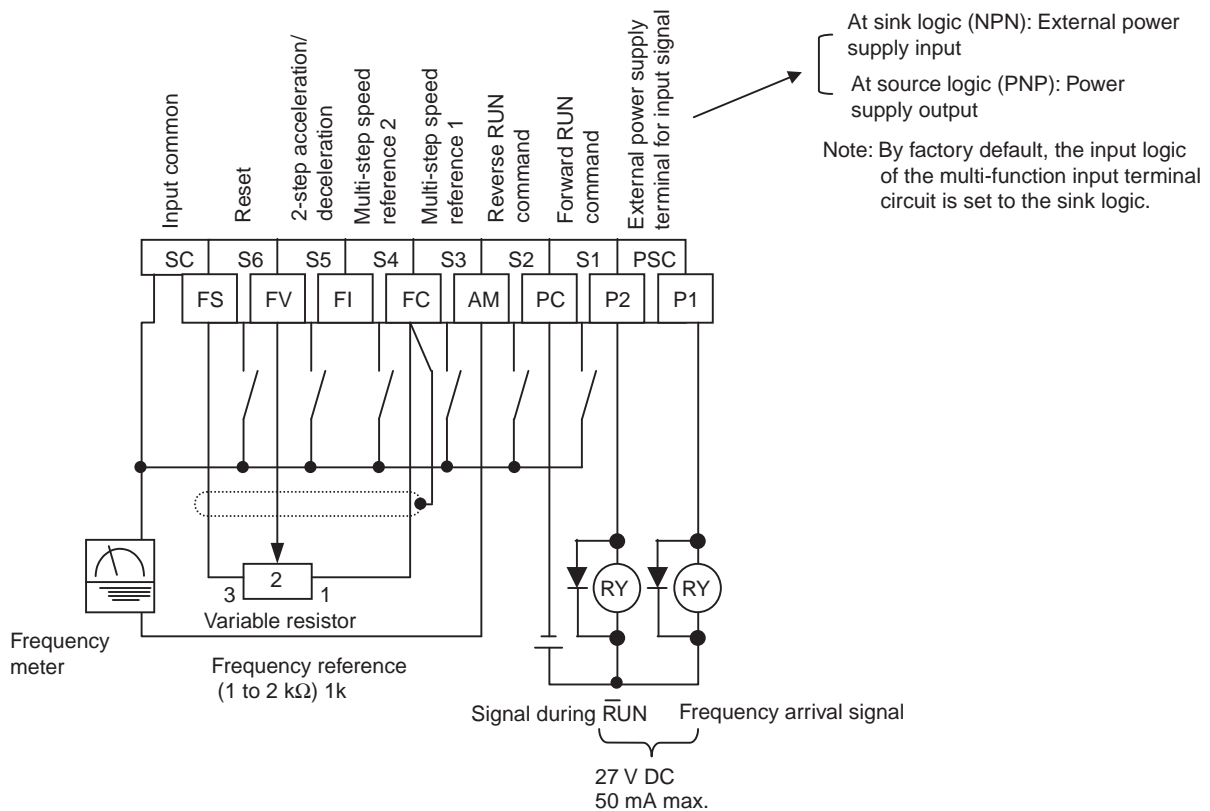

Note 1: When connecting a relay to the multi-function output terminal, install a surge-absorbing diode in parallel with the relay. The output circuit can break down due to surge voltage when the relay is switched on/off.

Note 2: For the signal line, use a twisted shield wire and apply the shield coating as illustrated on the next page. Keep the length to 20 m or less.

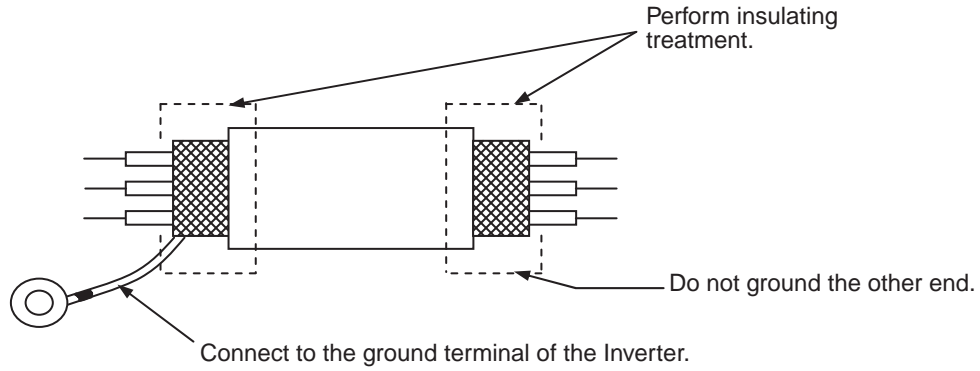

Note 3: Separate the wiring from the power cable of the main circuit and from the wiring on the relay control circuit. (More than 10 cm apart.)

Selecting the Sequence Input Method (Sink/Source Logic)

	Inverter's internal circuitry When interface power supply is used	When external power supply is used
Sink logic		
Source logic		

Wiring the Main Circuit Terminals

■Connecting the Main Circuit Terminals

Motor output (kW)	Applicable Inverter model	Wiring	Applicable device	
		Power cable	Earth leakage breaker (ELB)	Fuse size (class J) Rated 600 V
0.2	3G3MX-A2002	1.25 mm ²	(5 A)	10 A
0.4	3G3MX-A2004	1.25 mm ²	(5 A)	10 A
	3G3MX-A4004			3 A
0.75	3G3MX-A2007	2.0 mm ²	(10 A)	15 A
	3G3MX-A4007	1.25 mm ²	(5 A)	6 A
1.5	3G3MX-A2015	2.0 mm ²	(15 A)	15 A
	3G3MX-A4015	2.0 mm ²	(10 A)	10 A
2.2	3G3MX-A2022	2.0 mm ²	(20 A)	20 A
	3G3MX-A4022	2.0 mm ²	(10 A)	10 A
3.7	3G3MX-A2037	3.5 mm ²	(30 A)	30 A
	3G3MX-A4037	2.0 mm ²	(15 A)	15 A
5.5	3G3MX-A2055	5.5 mm ²	(50 A)	40 A
	3G3MX-A4055	2.0 mm ²	(30 A)	20 A
7.5	3G3MX-A2075	8.0 mm ²	(60 A)	50 A
	3G3MX-A4075	3.5 mm ²	(30 A)	25 A
0.2	3G3MX-AE002	1.25 mm ²	(5 A)	—
0.4	3G3MX-AE004	1.25 mm ²	(5 A)	—
0.75	3G3MX-AE007	2.0 mm ²	(10 A)	—
1.5	3G3MX-AE015	2.0 mm ²	(15 A)	—
2.2	3G3MX-AE022	2.0 mm ²	(20 A)	—

- For the main circuit terminals, always use insulated electrical wires with a rated voltage of 600 V and a rated temperature of 80°C or higher.
- Use the crimp-type terminal with an insulating sleeve to connect to the terminals.
- Up to two wires can be connected to one terminal.
- To prevent possible voltage drops, increase the wire size in accordance with the cable length.
- To connect the 100-V or 200-V model to the relay output terminal, use a wire of 0.75 mm².
- To connect seven wires or more to the control circuit terminal block, use a shield wire of 0.5 mm² or less.
- Strip the signal line by 5 to 6 mm, and connect the exposed wire. (In the case of stranded wires, make sure that the wires are not unraveled.)
- Make sure that the maximum outside coating diameter of the signal line is 2.0 mm or less (except for the alarm signal line). (For the mark tube mounted cable and multi-core cable, keep both the mark tube and the sheath-stripped length 40 mm or more from the connecting end. A thick line may prevent proper closing of the cover of the terminal block.)
- To meet the UL standards, always insert a UL-standard fuse (J type) on the power supply side.
- Use a ground wire with a larger diameter than that of the power cable shown above.

Choose the sensitivity current of the earth leakage breaker (ELB), depending on the total distance (L) between the Inverter and the power supply, and the Inverter and the motor.

L	Sensitivity current (mA)
100 m max.	30
300 m max.	100
800 m max.	200

Guide of leakage current: If a CV wire is used and routed through a metal pipe, the leakage current is 30 mA/km.

Due to the higher specific inductive capacity of the H-IV wire, the leakage current increases about eight times. Use a wire with a sensitivity current one-level higher. The leakage current mentioned here is the effective value of the fundamental wave, and high-frequency currents are excluded.

Terminal arrangement

Main circuit terminal block	Type	Screw size	D (mm)
	A2002 to A2007 AE002 to AE004 (*1)	M3.5	7.6
	A2015 to A2037 A4004 to A4037 AE007 to AE022 (*1)	M4	10
	A2055 to A2075 A4055 to A4075	M5	13

Ground Terminal Block

7.6 (10)

Main Circuit Terminal Block

*1. For 3G3MX-AE□□□, L1, L2, N/L3 are indicated instead of R/L1, S/L2, T/L3 respectively.

Type	A2002 to A2007 AE002 to AE004		A2015 to A2037 A4004 to A4037 AE007 to AE022		A2055 to A2075 A4055 to A4075	
	Screw size	D (mm)	Screw size	D (mm)	Screw size	D (mm)
Main circuit	M3.5	7.6	M4	10	M5	13
Control circuit	M2	—	M2	—	M2	—
Relay	M2.5	—	M2.5	—	M2.5	—
Ground	M4	—	M4	—	M6	—

Screw Tightening Torque

Screw	Tightening torque
M2	0.2 N•m (max. 0.25 N•m)
M2.5	0.5 N•m (max. 0.6 N•m)
M3.5	0.8 N•m (max. 0.9 N•m)
M4	1.2 N•m (max. 1.3 N•m)
M5	2.0 N•m (max. 2.6 N•m)

Control Circuit Terminal Block

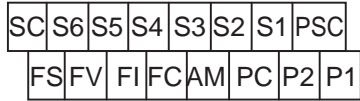

Relay output terminal block



■ Explanation of the Main Circuit Terminal Connection

Terminal symbol	Terminal name	Function	Connection example
R/L1, S/L2, T/L3 *	Main power supply input terminal	Connect the input power supply.	
U/T1, V/T2, W/T3	Inverter output terminal	Connect to the motor.	
+1, P/+2	External DC reactor terminal	Normally connected by the short-circuit bar. Remove the short-circuit bar between +1 and P/+2 when a DC reactor is connected.	
P/+2 RB	External braking resistor connection terminal	Connect the optional braking resistor. (If a braking torque is required)	
P/+2, N/-	Regenerative braking unit connection terminal	Connect optional regenerative braking units. (If a braking torque is required) (if insufficient with only the built-in braking circuit)	
	Ground terminal	Ground (Connect to the ground to prevent electric shock and reduce noise.)	Do not remove the short-circuit bar between +1 and P/+2 when a DC reactor is not connected.

* Terminal symbols for 3G3MX-AE□□□ are indicated as L1, L2, N/L3 instead of R/L1, S/L2, T/L3 respectively.

■ Main Circuit Connection Diagram

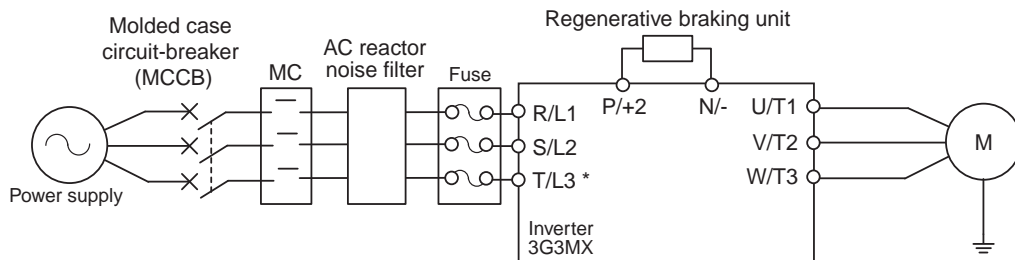

* Terminal symbols for 3G3MX-AE□□□ are indicated as L1, L2, N/L3 instead of R/L1, S/L2, T/L3 respectively.

■Wiring the Main Circuit Terminals (Input Side)

Installing a Molded-case Circuit Breaker (MCCB)

- Always connect the Inverter and power supply via a molded-case circuit breaker (MCCB) to protect the Inverter from damage that may result from short-circuiting.
- Always connect the power input terminals (R/L1, S/L2, and T/L3) and power supply via an MCCB, according to the Inverter capacity.
- Install one MCCB per Inverter.
- Choose an appropriate MCCB capacity according to the fuse size on page 2-15.
- When choosing an MCCB's time characteristics, be sure to consider the Inverter's overload protection (1 minute at 150% of the rated output current).
- By programming the sequence as illustrated below, you can turn off the power via the relay outputs (MA, MB, and MC) for the 3G3MX Series.

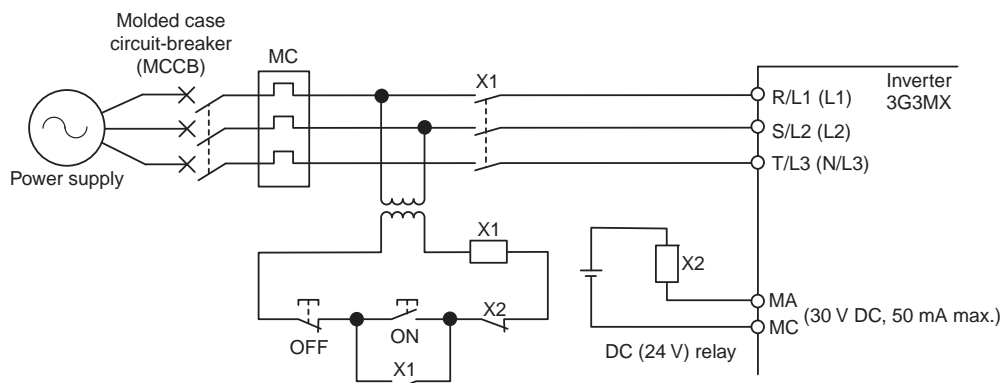

* Terminal symbols for 3G3MX-AE□□□ are indicated in parentheses ().

Installing a Ground Fault Interrupter

- The Inverter's output uses high-speed switching, and so generates high-frequency current leakage. (Generally, if the power cable is 1 m, the leakage current is approx. 100 mA per Inverter, and approx. 5 mA is added per additional meter.)
- At the power supply input part, install a special-purpose ground fault interrupter for Inverters that exclude high-frequency leakage current and detect only the leakage current within a frequency range that is hazardous to humans. (Choose a ground fault interrupter with a sensitivity current of at least 10 mA per Inverter.)
- Alternatively, use a general ground fault interrupter with a sensitivity current of 200 mA or more per Inverter, and with an operating time of 0.1 s or more.

Installing a Magnetic Contactor (MC)

- If the power supply of the main circuit is shut off due to sequencing, a magnetic contactor (MC) can be used. (When forcibly stopping the load with an MC on the primary side of the main circuit, however, the regenerative braking does not work and the load coasts to a stop (free run).)
- Frequently opening and closing the magnetic contactor (MC) to start and stop a load may cause the Inverter to break down. To extend the life of the Inverter's internal electrolytic capacitor, limit the frequency to no more than once every 30 minutes.

Connection Sequence to the Terminal Block

- Input power supply can be connected to any terminal because the phase sequence of the input power supply is irrelevant to that of the terminal block (R/L1, S/L2, and T/L3).

Installing an AC Reactor

- If the Inverter is connected to a large-capacity power transformer (660 kVA or more) or the phase advance capacitor is in use, a large peak current may flow through the input power circuit, causing the converter unit to break down.
- Install an optional AC reactor on the input side of the Inverter. An AC reactor will also improve the power factor of the power input side.

Installing a Surge Absorber

- Always use a surge absorber or diode when magnetic contactors (MC), electromagnetic relays, solenoid valves, solenoid, and magnetic brakes are used.

Connecting a Regenerative Braking Unit

When running a load with a large inertia or a vertical axis, regenerative energy will return to the Inverter.

If overvoltage in the main circuit is generated during deceleration, this indicates that the regenerative energy exceeds the capacity of the Inverter. In this case, use a regenerative braking unit.

- When using a regenerative braking unit, be sure to include a sequence whereby the power supply for the Inverter will be turned off in the event of abnormal overheating. Not doing so may result in fire or other hazards.

For a regenerative braking unit: Use the error contact output (MA, MB).

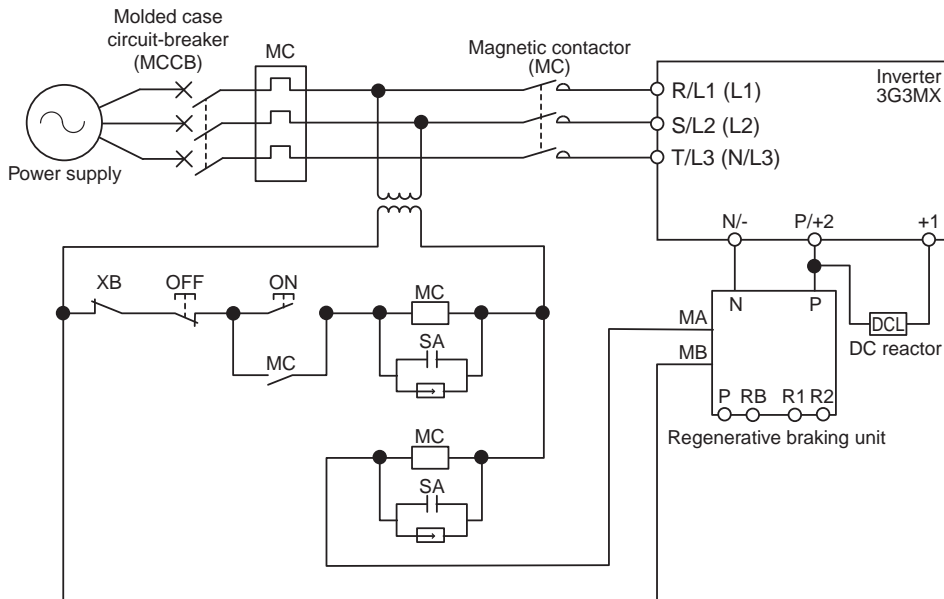

* Terminal symbols for 3G3MX-AE□□□ are indicated in parentheses ().

<Braking Resistors and Braking Resistor Units for the Inverter>

Name	Model	Specifications	
Regenerative braking unit	3G3AX-RBU21	3/1-phase 200 V	For general use (with built-in resistor)
	3G3AX-RBU22		For heavy instantaneous regenerative power (with built-in resistor)
	3G3AX-RBU41	3-phase 400 V	For general use (with built-in resistor)

Installing a Noise Filter on the Input Side

- The Inverter's output uses high-speed switching, so noise may be transmitted from the Inverter to the power line, affecting peripheral devices.
- It is recommended that a noise filter be installed on the input side to minimize noise transmission. (Installing a noise filter on the input side can also reduce the noise from the power line to the Inverter.)

<Recommended Input Noise Filters for the Inverter>

General	EMC-conforming
3G3AX-NFI	3G3AX-EFI

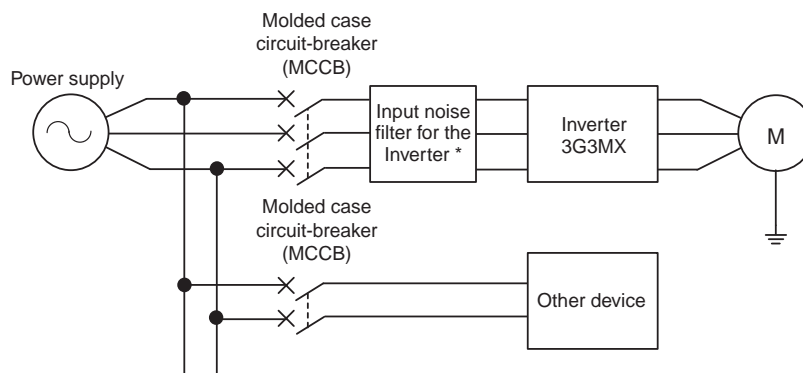

* Use a noise filter designed for Inverters. A general-purpose noise filter may be less effective and not reduce noise.

■ Wiring the Main Circuit Terminals (Output Side)

Connect the Terminal Block to the Load

- Connect motor output terminals U/T1, V/T2, and W/T3 to motor lead wires U, V, and W.
- Check that the motor rotates forward with the forward command. Switch over any two of the output terminals (U/T1, V/T2, W/T3) and reconnect if the motor rotates in reverse to the forward command.

Never Connect a Power Supply to the Output Terminals

- If voltage is applied to the output terminals, the internal circuit of the Inverter will be damaged. Never connect a power supply to output terminals U/T1, V/T2, or W/T3.

Never Short-circuit or Ground the Output Terminals

- Never touch the output terminals by hand.
- If the output wires come into contact with metal materials, an electric shock or ground fault will occur. This is extremely hazardous. Be careful not to short-circuit the output wires.

Do Not Use a Phase Advance Capacitor or Noise Filter

- Doing so may result in damage to the Inverter or cause the parts to burn. Never connect a phase advance capacitor or LC/RC noise filter to the output circuit.

Do Not Use an Electromagnetic Switch

- If a load is connected to the Inverter during running, an inrush current will actuate the overcurrent protective circuit in the Inverter. Do not connect an electromagnetic switch or magnetic contactor (MC) to the output circuit.

Install a Noise Filter on the Output Side

Connect a noise filter to the output side of the Inverter to reduce induction and radio noise.

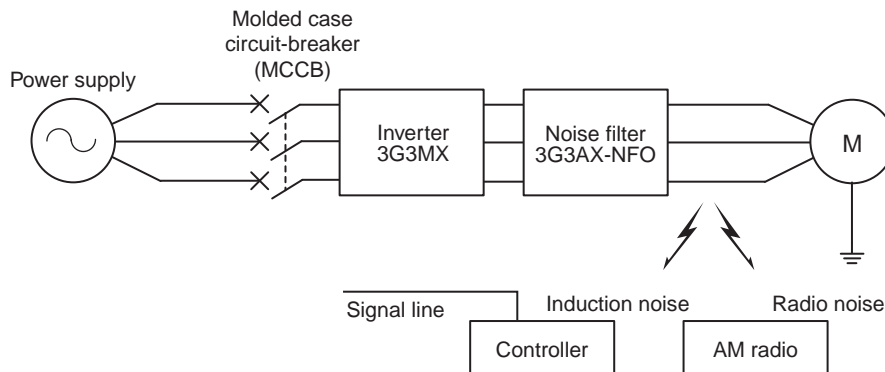

Induction noise: Electromagnetic induction can generate noise on the signal line, causing the controller to malfunction.

Radio noise: Electromagnetic waves from the Inverter and I/O cables can cause the radio receiver to generate noise.

Countermeasures Against Induction Noise

To reduce induction noise from the output side, the following method is also effective.

- Run the cables collectively through the mounted metal pipe. Keeping the metal pipe at least 30 cm away from the signal line reduces induction noise.

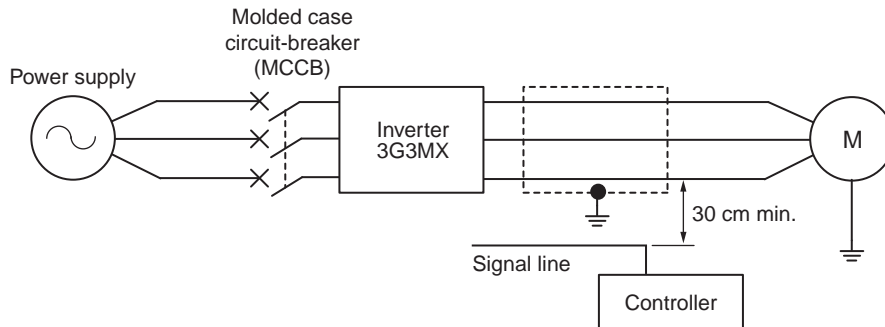

Cable Length Between Inverter and Motor

Use a cable of 50 m or less between the Inverter and the motor. If the cable length is increased, the stray capacitance between the Inverter outputs and the ground is increased proportionally. An increase in stray capacitance causes high-frequency leakage current to increase, affecting the current detector in the Inverter's output unit and peripheral devices. If your system configuration requires a cable length of 50 m or more, perform the following:

- Wire in metallic ducts.
- Use single-wire cables for each phase.
- Set the Inverter to a lower carrier frequency (b083).

Do Not Use Single-phase Motors

- A single-phase motor uses the capacitor start method or split-phase start method to determine its rotation direction at startup, and thus is not suitable for the variable speed control via the Inverter. Do not use single-phase motors.
- *If a capacitor start motor is used, the capacitor may be damaged by a sudden electric charge and discharge caused by Inverter output. If a split-phase start motor is used, the startup coil may burn because the centrifugal switch does not operate.

■ Specifications of Control Circuit Terminals

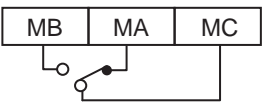
	Terminal symbol	Terminal name and function	Default setting	Specifications
Input signal	PSC	External power supply terminal for input signal (input) ...At sink logic	—	24 V DC ±10% 30 mA max.
		Internal power supply output terminal for input signal (output) ...At source logic		24 V ±10% 100 mA max
	S1	Multi-function input S1 to S6 Select 6 functions among the 30 functions and allocate them to terminals S1 to S6.	Forward/Stop	Contact input Close: ON (Start) Open : OFF (Stop)
	S2		Reverse/Stop	
	S3		Fault reset	
	S4		External trip	
	S5		Multi-step speed reference 1	Minimum ON time: 12 ms min.
	S6		Multi-step speed reference 2	
SC	Input signal common	—		
Monitor signal	AM	Analog frequency monitor/ Analog output current monitor	Analog frequency monitor	
	SC	Monitor common	—	
Frequency reference input	FS	Frequency reference power supply	—	10 V DC 10 mA max.
	FV	Voltage frequency reference signal	—	0-10 V DC Input impedance 10 Ω
	FI	Current frequency reference signal	—	DC 4-20 mA Input impedance 250 Ω
	FC	Frequency reference common	—	
Output signal	P1	Multi-function Output Terminal Select 2 functions of the Inverter status and allocate them to terminals P1 and P2.	Frequency arrival signal at a constant speed	27 V DC 50 mA max.
	P2		Signal during RUN	
	PC	Output signal common	—	
Relay output signal *1	MA		Factory default relay settings Under normal operation : MA-MC Close Under abnormal operation or power shutdown : MA-MC Open	
	MB			
	MC			

*1. Below are the contact specifications of the relay outputs.

Output terminal		Resistance load	Inductive load
MA-MC	Max. contact capacity	250 V AC, 2 A 30 V DC, 3 A	250 V AC, 0.2 A 30 V DC, 0.6 A
	Min. contact capacity	100 V AC, 10 mA 5 V DC, 100 mA	
MB-MC	Max. contact capacity	250 V AC, 1 A 30 V DC, 1 A	250 V AC, 0.2 A 30 V DC, 0.2 A
	Min. contact capacity	100 V AC, 10 mA 5 V DC, 100 mA	

■ Mode Selector

For the mounting position of each selector, refer to page 1-6.

<Input Logic Selector>

Available to switch the input logic (source or sink) in the multi-function input terminal circuit.

Symbol	Name	Status	Description
SR/SK	Input logic selector	SR	Source logic
		SK [Default]	Sink logic

<RS-485 Communication/Operator Selector>

Select the mode according to the option connected to the communications connector.
The 3G3AX-OP01 supplied with the Inverter can be used regardless of the switch condition.



Symbol	Name	Status	Description
485/OPE	RS-485 communication/ operator selector	485	ModBus communication
		OPE [Default]	Digital Operator (Option: 3G3AX-OP01)

<Frequency Reference/RUN Command Source Selector>

Switches the source for frequency reference and RUN command of the Inverter.

Symbol	Name	Status	Description
TM/PRG	Frequency reference/ RUN command source selector	TM	Control terminal block (terminals): The set values in A001 and A002 are disabled. Frequency reference: Analog external input (FV, FI) RUN command : Operation using the FW or RV terminal 00(FW) or 01 (RV) must be allocated to the multi-function input terminals.
		PRG [Default]	Digital Operator setting (depends on the set values in A001 and A002.) Frequency reference: Adjuster (factory default) Available to change with the frequency reference selection (A001). RUN command : Digital Operator Available to change with the RUN command selection (A002).

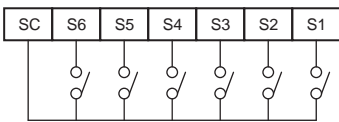
■ Functions of the Control Circuit Terminals

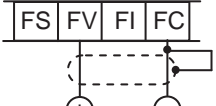
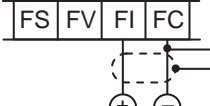
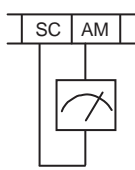
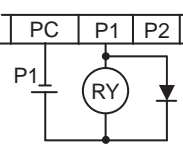
Terminal function	Terminal Symbol	Terminal name	Function and connecting method	Wire size
Contact input (for switching function)	S1 S2 S3 S4 S5 S6	Multi-function input	Select functions and allocate them to terminals S1 to S6. (The figure below illustrates the wiring of the sink logic.) 	
Power supply	SC	Input common	Input signal common	
	PSC	Input power supply	If the multi-function input terminal is set as the sink logic, the PSC terminal acts as an external power supply input terminal. If the multi-function input terminal is set as the source logic, the PSC terminal acts as an internal power supply output terminal.	
External analog frequency reference	FS	Frequency reference power supply output	<ul style="list-style-type: none"> External voltage directive is 0 to 9.8 V. (Nominal input: 10 V)  Variable resistor (1/2 W min.) 1 to 2 kΩ  0 to 9.8 V DC (Nominal input: 10 V) Input impedance 10 kΩ  4 to 19.6 mA DC (Nominal input: 20 mA) Input impedance 250 Ω Note: When the multi-function input terminal has no allocation of [16: AT], the frequency of total voltage and current directive values will be output. When selecting and using either the voltage or current, be sure to allocate [16: AT] to the multi-function input terminal.	Shield wire of 0.14 to 0.75 mm ² Recommended wire size: 0.75 mm ²
	FV	Frequency reference input (Voltage directive)		
	FI	Frequency reference input (Current directive)		
	FC	Frequency reference common		
Monitor output	AM	Multi-function analog output	<ul style="list-style-type: none"> Choose from frequency or output current. Output terminal specifications 0 to 10 V DC full-scale 1 mA max. 	
Open collector output	P1 P2	Multi-function output *1	 Output terminal specifications Open collector output 27 V DC max. 50 mA max. Select 2 functions of the Inverter status and allocate them to terminals P1 and P2.	
	PC	Multi-function output common		
Relay contact output	MA MB	Relay output *2	Selection of functions is the same as the multi-function output. *3 *4	
	MC	Relay output common		

*1. By factory default, multi-function output terminals, [P1] and [P2] are set to NO contact. To switch to NC contact, change the C031 and C032 settings. In addition, these terminals are reset to NO contact when initialized.

*2. The factory default setting (C036) of the relay output terminals (MA, MB-MC) is set to NC contact. In addition, these terminals are reset to NC contact when initialized.

To use the Inverter as an alternative to a conventional model or for built-in use with a system, check the contact logic of the relay output terminal setting (C036), and match the logic with that of the peripheral circuit before use. If these contact logics conflict with each other, a system breakdown may occur.

*3. Output signal status

C036 set value	Power supply	Output signal	Output terminal status	
00	ON	ON	Closed	Open
		OFF	Open	Closed
	OFF	—	Open	Closed
01 (Factory default)	ON	ON	Open	Closed
		OFF	Closed	Open
	OFF	—	Open	Closed

*4. Contact specifications

Output terminal		Resistance load	Inductive load
MA-MC	Max.	250 V AC, 2 A 30 V DC, 3 A	250 V AC, 0.2 A 30 V DC, 0.6 A
	Min.	100 V AC, 10 mA 5 V DC, 100 mA	
MB-MC	Max.	250 V AC, 1 A 30 V DC, 1 A	250 V AC, 0.2 A 30 V DC, 0.2 A
	Min.	100 V AC, 10 mA 5 V DC, 100 mA	

■ Mode Selector List

Symbol	Name	Description	
SR/SK	Input logic selector	Available to switch the input logic (source or sink) in the multi-function input terminal circuit.*1	
		SR	Source logic
		SK [factory default]	Sink logic
485/OPE	RS-485 communication/operator selector	Select the mode according to the option connected to the communications connector.*2	
		485	ModBus communication
		OPE [factory default]	Digital Operator (Option: 3G3AX-OP01)
TM/PRG	Frequency reference/RUN command source selector	Switches the source for frequency reference and RUN command of the Inverter.	
		TM	Control terminal block (Terminals) Frequency reference: Analog external input (FV, FI) RUN command : Operation using the FW or RV terminal 00 (FW) or 01 (RV) must be allocated to the multi-function input terminals.
		PRG [factory default]	Digital Operator settings (depends on the set values in A001 and A002.) Frequency reference: FREQ adjuster (factory default) Available to change with the frequency reference selection (A001). RUN command : Digital Operator (factory default) Available to change with the RUN command selection (A002).

*1. The PSC terminal I/O will be switched accordingly. Do not switch the selector while the power is being supplied. Doing so may damage the Inverter.

*2. When using the 3G3MX Series standard Digital Operator, it can be used regardless of the 485/OPE communications selector.

Conforming to EC Directives

■ Conforming Standards

- EMC directive EN 61800-3
- Low-voltage directive EN 61800-5-1

■ Concept of Conformity

EMC Directive

OMRON products are the electrical devices incorporated and used in various machines or manufacturing equipment. For this reason, we make efforts to conform our products to their related EMC standards so that the machines or equipment which have incorporated our products should easily conform to the EMC standards. The 3G3MX models have conformed to the EMC directive EN 61800-3 by following the installation and wiring method as shown below. Your machines or equipment, however, vary in type, and in addition, EMC performance depends on the configuration, wiring, or location of the devices or control panels which incorporate the EC directive conforming products. This in turn does not allow us to confirm the condition and the conformity in which our products are used. Therefore, we appreciate confirmation of the final EMC conformity for the whole machine or equipment on your own.

Wiring the Power Supply

- Be sure to connect the power input terminals (R/L1, S/L2, and T/L3) and power supply via an EMC conforming dedicated noise filter 3G3AX-EFI □□.
- Keep the ground cable as short as possible.
- Keep the cable between the Inverter and the noise filter as short as possible.

Connecting a Motor to the Inverter

- When connecting a motor to the Inverter, be sure to use shield braided cables.
- Keep the cables as short as possible.

Low-voltage Directive

The 3G3MX models have conformed to the EMC directive EN61800-5-1 by performing the machine installation and wiring as shown below.





- The 3G3MX models are an open type device. Be sure to install it inside the control panel.
- The power supply and voltage (SELV) with reinforced or double insulation should be used for wiring to the control circuit terminals.
- To satisfy requirements of the LVD (low-voltage) directive, the Inverter must be protected with a molded case circuit breaker (MCCB) in case a short-circuiting accident occurs. Be sure to install a molded case circuit breaker (MCCB) on the power supply side of the Inverter.
- Use one molded case circuit breaker (MCCB) per Inverter.
- Use the crimp-type terminal with an insulation sleeve to connect to the main circuit terminals.
- When not using the braking resistor or braking resistor unit, connect the crimp-type terminal with an insulation sleeve to the braking resistor connection terminals (P/+2, N/-).

Chapter 3



Operation

3-1	Test Run Procedure	3-2
3-2	Test Run Operation	3-3
3-3	Part Names and Descriptions of the Digital Operator	3-8
3-4	Operation Procedure (Example: Factory Default)	3-10
3-5	Keys.....	3-16
3-6	Parameter Transition	3-17
3-7	Parameter List	3-19

WARNING

	Do not put on or take off the Digital Operator control circuit terminal block terminal block cover while the input power is being supplied. Doing so may result in a serious injury due to an electric shock.
	Do not remove the terminal block cover during the power supply and 5 minutes after the power shutoff. Doing so may result in a serious injury due to an electric shock.
	Do not operate the Digital Operator or switches with wet hands. Doing so may result in a serious injury due to an electric shock.
	Do not change wiring, mode change switches, optional devices or replace cooling fans while power is being supplied. Doing so may result in a serious injury due to an electric shock.

CAUTION

	Do not touch the Inverter fins, braking resistors and the motor, which become too hot during the power supply and for some time after the power shutoff. Doing so may result in a burn.
	Take safety precautions such as setting up a molded-case circuit breaker (MCCB) that matches the Inverter capacity on the power supply side. Not doing so might result in damage to property due to the short circuit of the load.

Safety Information

■ Operation and Adjustment

- Be sure to confirm the permissible range of motors and machines before operation because the Inverter speed can be changed easily from low to high.
- Provide a separate holding brake if necessary.

Precautions for Use





■ Error Retry Function

- Do not come close to the machine when using the error retry function because the machine may abruptly start when stopped by an alarm.
- Be sure to confirm the RUN signal is turned off before resetting the alarm because the machine may abruptly start.

■ Operation Stop Command

- Provide a separate emergency stop switch because the STOP key on the Digital Operator is valid only when function settings are performed.
- When checking a signal during the power supply and the voltage is erroneously applied to the control input terminals, the motor may start abruptly. Be sure to confirm safety before checking a signal.

3-1 Test Run Procedure

Item	Description	Reference page																
Installation and Mounting	Install the Inverter according to the installation conditions.	2-1																
	<ul style="list-style-type: none"> •Make sure that the installation conditions are met. 																	
Wiring and Connection	Connect to the power supply and peripheral devices.	2-10																
	<ul style="list-style-type: none"> •Select peripheral devices that meet the specifications, and wire correctly. 																	
Power On	Check the following before turning on the power.																	
	<ul style="list-style-type: none"> •Make sure that an appropriate power supply voltage is supplied and that the power input terminals (R/L1, S/L2, and T/L3) are wired correctly. <ul style="list-style-type: none"> 3G3MX-A2□: 3-phase 200 to 240 V AC 3G3MX-AE□: 1/3-phase 200 to 240 V AC (Connect to L1 and N/L3 for 1 phase) 3G3MX-A4□: 3-phase 380 to 480 V AC •Make sure that the motor output terminals (U/T1, V/T2, and W/T3) are connected to the motor correctly. •Make sure that the control circuit terminals and the control device are wired correctly and that all control terminals are turned off. •Set the motor to a no-load state (i.e., not connected to the mechanical system). •After checking the above, turn on the power. 																	
Display Status Check	Make sure that there are no faults in the Inverter.																	
	<ul style="list-style-type: none"> •When the power is turned on normally, the display shows: <table border="0"> <tr> <td>RUN LED indicator</td> <td>: ON</td> <td>ALARM LED indicator</td> <td>: OFF</td> </tr> <tr> <td>POWER LED indicator</td> <td>: ON</td> <td>RUN command LED indicator</td> <td>: ON</td> </tr> <tr> <td>Volume LED indicator</td> <td>: ON</td> <td>Data LED indicator (frequency)</td> <td>: ON</td> </tr> <tr> <td>Data display</td> <td colspan="3">: Displays the set value in d001.</td> </tr> </table> •If an error occurs, the error code is displayed on the data display. In this case, refer to "Chapter 5 Maintenance Operations" and make the necessary changes to remedy. 	RUN LED indicator	: ON	ALARM LED indicator	: OFF	POWER LED indicator	: ON	RUN command LED indicator	: ON	Volume LED indicator	: ON	Data LED indicator (frequency)	: ON	Data display	: Displays the set value in d001.			
RUN LED indicator	: ON	ALARM LED indicator	: OFF															
POWER LED indicator	: ON	RUN command LED indicator	: ON															
Volume LED indicator	: ON	Data LED indicator (frequency)	: ON															
Data display	: Displays the set value in d001.																	
Parameter Initialization	Initialize the parameters.																	
	<ul style="list-style-type: none"> •Set parameter b084 to "02", and press the  key while holding down the , , and  keys simultaneously. 																	
Parameter Settings	Set the parameters required for a test run.																	
	<ul style="list-style-type: none"> •Set the motor capacity selection (H003) and the motor pole number selection (H004). 																	
No-load Operation	Start the no-load motor via the Digital Operator.																	
	<ul style="list-style-type: none"> •Use the FREQ adjuster on the Digital Operator to rotate the motor. 																	
Actual Load Operation	Connect the mechanical system and operate via the Digital Operator.																	
	<ul style="list-style-type: none"> •If there are no difficulties with the no-load operation, connect the mechanical system to the motor and operate via the Digital Operator. 																	
Operation	Refer to "Chapter 4 Functions", and set the necessary parameters.																	

3-2 Test Run Operation

Power On

■ Checkpoints Before Turning On the Power

- Make sure that an appropriate power supply voltage is supplied and that the power input terminals (R/L1, S/L2, and T/L3) are wired correctly.
 - 3G3MX-A2□: 3-phase 200 to 240 V AC
 - 3G3MX-AE□: 1/3-phase 200 to 240 V AC (Connect to L1 and N/L3 for 1 phase)
 - 3G3MX-A4□: 3-phase 380 to 480 V AC
- Make sure that the motor output terminals (U/T1, V/T2, and W/T3) are connected to the motor correctly.
- Make sure that the control circuit terminals and the control device are wired correctly and that all control terminals are turned off.
- Set the motor to a no-load state (i.e., not connected to the mechanical system).

■ Power On

- After checking the above, turn on the power.

Display Status Check

- When the power is turned on normally, the display shows:























[Normal]	RUN LED indicator (during RUN)	: ON	ALARM LED indicator	: OFF
	POWER LED indicator	: ON	RUN command LED indicator	: ON
	Volume LED indicator	: ON	Data LED indicator (frequency)	: ON
	Data display	: Displays the set value in d001		

- If an error occurs, refer to "Chapter 5 Maintenance Operations" and make the necessary changes to remedy.

[Fault]	RUN LED indicator (during RUN)	: ON	ALARM LED indicator	: ON
	POWER LED indicator	: ON	RUN command LED indicator	: ON
	Volume LED indicator	: ON	Data LED indicator (frequency)	: ON
	Data display	: An error code, such as "E-01", is displayed. (The display varies depending on the type of error.)		











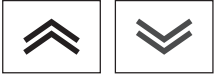

Parameter Initialization

- Initialize the parameters using the following procedure.
- To initialize the parameters, set parameter b084 to "02".

Key sequence	Display example	Description
		Power On
 		Press the Mode key once, and then press the Decrement key three times to display "b---".
		Press the Mode key. "b001" is displayed.
 		Use the Increment or Decrement key to display "b084".
		Press the Mode key. The set value in "b084" is displayed.
 		Use the Increment or Decrement key to display "02".
		Press the Enter key. The set value is entered and "b084" is displayed.
   		Press the STOP/RESET key while holding down the Mode, Increment, and Decrement keys simultaneously. When the display blinks, release the STOP/RESET key first, and then the Mode and Decrement keys.
		Displays initialization.
(In 1 s)		The parameter number is displayed again in approximately 1 s.

Setting the Motor Capacity Selection (H003), Motor Pole Number Selection (H004) and Motor Voltage Selection (H007)

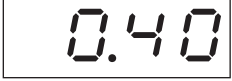





Parameter No.	Name	Description	Setting range	Unit of Setting	Default setting	Interrupt during RUN
H003	Motor capacity selection	Sets the capacity of the motor connected to the Inverter.	200-V class 0.2/0.4/0.75/1.5/ 2.2/3.7/5.5/7.5 400-V class 0.4/0.75/1.5/2.2/ 3.7/5.5/7.5	kW	Varies with the capacity.	No
H004	Motor pole number selection	Sets the pole number of the motor connected to the Inverter.	2/4/6/8	Pole	4	No
H007	Motor voltage selection	Sets the voltage of the motor connected to the Inverter.	00: 200 V 01: 400 V	—	Depends on the Inverter model	No

Key sequence	Display example	Description
		Press the Mode key twice to display the mode selection.
		Use the Increment or Decrement key to display "H---".
		Press the Mode key. "H003" is displayed.
		Press the Mode key. The set value in "H003" is displayed.
		Use the Increment or Decrement key to set the rated motor capacity.
		Press the Enter key. The set value is entered.
(In approx. 1 s)		The parameter number is displayed again.

No-load Operation

- Start the no-load motor (i.e., not connected to the mechanical system) using the Digital Operator.
- * Before operating the Digital Operator, check that the FREQ adjuster is set to "MIN."
- * Make sure that the LED indicator above the FREQ adjuster and the RUN command LED indicator are lit.

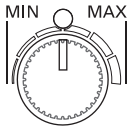
■ Forward/Reverse Rotation via the Digital Operator

Key sequence	Display example	Description
		Press and hold the Mode key for 3 seconds or more to display "d001", and then press again. (Monitors the frequency reference.)
		Press the RUN key. The RUN command LED indicator is lit.
		Turn the FREQ adjuster slowly. The monitor value of the frequency reference is displayed. The motor starts rotating forward in accordance with the frequency reference.

- By turning the FREQ adjuster, make sure that there is no vibration or abnormal sound from the motor.
- Make sure that no errors have occurred in the Inverter during operation.
- Switch between forward and reverse with the operator rotation direction selection (F004).

■ Stopping the Motor

- After completing the no-load operation, press the STOP/RESET key. The motor will stop.

Actual Load Operation

- After checking the operation with the motor in the no-load status, connect the mechanical system and operate with an actual load.
- * Before operating the Digital Operator, check that the FREQ adjuster is set to "MIN."

■ Connecting the Mechanical System

- After confirming that the motor has stopped completely, connect the mechanical system.
- Be sure to tighten all the screws when fixing in the motor axis.

■ Operation via the Digital Operator

- Because a possible error may occur during operation, make sure that the STOP/RESET key on the Digital Operator is easily accessible.
- Use the Digital Operator to operate the Inverter the same way as in no-load operation.

■Checking the Operating Status

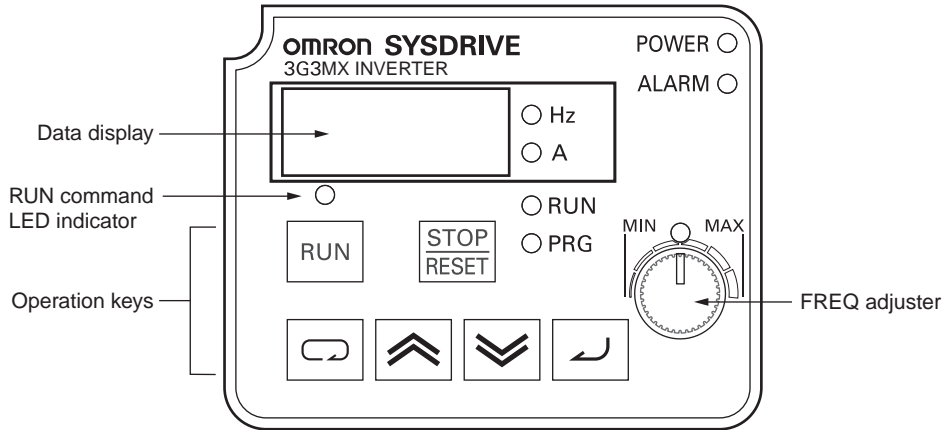

- After making sure that the operating direction is correct and that the Inverter is operating smoothly at a slow speed, increase the frequency reference.
- By changing the frequency reference or the rotation direction, make sure that there is no vibration or abnormal sound from the motor.
Make sure that the output current (output current monitor [d002]) is not excessive.

3-3 Part Names and Descriptions of the Digital Operator



	Name	Description
POWER ○	POWER LED indicator	Lit when the power is supplied to the control circuit.
ALARM ○	ALARM LED indicator	Lit when an Inverter error occurs.
○ RUN	RUN (during RUN) LED indicator	Lit when the Inverter is running.
○ PRG	PROGRAM LED indicator	Lit when the set value of each function is indicated on the data display. Blinks during warning (when the set value is incorrect).
	Data display	Displays relevant data, such as frequency reference, output current, and set values.
○ Hz ○ A	Data LED indicator	Lit according to the indication on the data display. Hz: Frequency A: Current
	Volume LED indicator	Lit when the frequency reference source is set to the FREQ adjuster.
	FREQ adjuster	Sets a frequency. Available only when the frequency reference source is set to the FREQ adjuster. (Check that the Volume LED indicator is lit.)
○	RUN command LED indicator	Lit when the RUN command source is set to the Digital Operator. (The RUN key on the Digital Operator is available for operation.)
	RUN key	Activates the Inverter. Available only when operation via the Digital Operator is selected. (Check that the RUN command LED indicator is lit.)
	STOP/RESET key	Decelerates and stops the Inverter. Functions as a reset key if an Inverter error occurs.
	Mode key	Switches between: the monitor mode (d□□□), the basic function mode (F□□□), and the extended function mode (A□□□, b□□□, C□□□, H□□□).

3-3 Part Names and Descriptions of the Digital Operator

	Name	Description
	Enter key	Enters the set value. (To change the set value, be sure to press the Enter key.)
	Increment key	Changes the mode. Also, increases the set value of each function.
	Decrement key	Changes the mode. Also, decreases the set value of each function.

3

Operation

3-4 Operation Procedure (Example: Factory Default)

Displaying the Monitor Mode, Basic Function Mode, and Extended Function Mode

Power On



1. The data of the set monitor is displayed. (Default is "0.0")

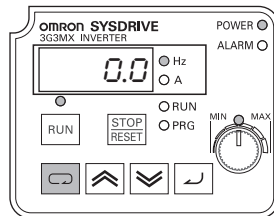

↑↓ Press .

2. The code of the monitor mode is displayed (as "d001").

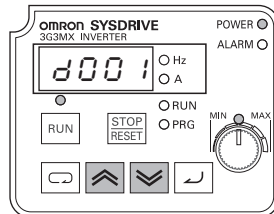

- Press the Mode key once to return from the code display of the monitor mode to the monitor display.

Press . ↑↓ Press .

("d002" is displayed.)

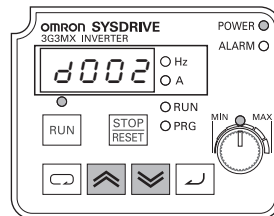

Press  (13 times). ↑↓ Press  (13 times).

(Continued to the next page)

3. The code of the basic function mode is displayed (as "F001").

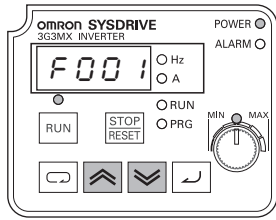

Press  .   Press  .
(4 times) (4 times)

4. The extended function mode is displayed (as "A---").

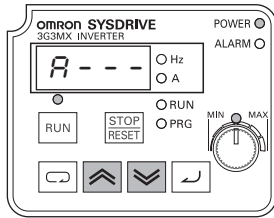

- Extended function mode
Displays in order of A ⇔ b ⇔ C ⇔ H.

Press  .   Press  .
(4 times) (4 times)

5. The code of the monitor mode is displayed (as "d001").

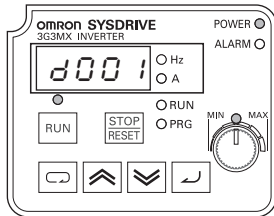

- Returns to step 2.

Setting Functions

- Switch the method of the RUN command. (Digital Operator → Control terminal block)
- To switch the method of the RUN command from the Digital Operator (factory default) to the control terminal block, you need to change the frequency reference selection (A001) from the Digital Operator (02) to the terminal (01).

1. Display the extended function mode (as "A---").

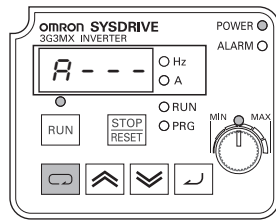

↓ Press .

- To display "A---", follow the indication method described in "Displaying the Monitor Mode, Basic Function Mode, and Extended Function Mode" (page 3-10)".
- By default, the RUN command LED indicator will light up as the RUN command source is set to the Digital Operator.

2. The code of the extended function mode is displayed (as "A001").

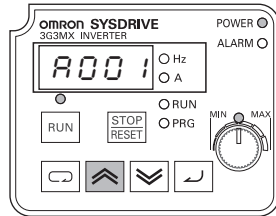

↓ Press .

("A002" is displayed.)

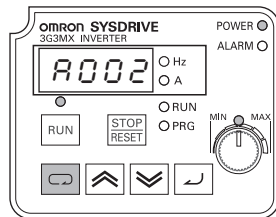

↓ Press .

3. The setting of the extended function mode is displayed (setting in "A002").

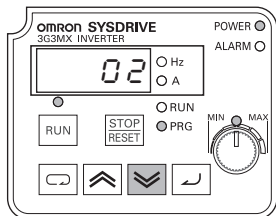

↓ Press .

- "02 (Digital Operator)" (default setting) is displayed in the RUN command source (A002).
- The PROGRAM (PRG) LED indicator lights up while the extended function mode setting is displayed.

(Continued to the next page)

(Change the A002 setting.)

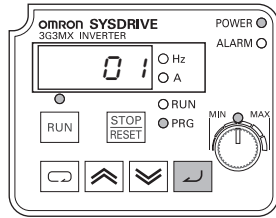

- Change the RUN command source to the control terminal "01".

↓ Press  .

4. The code of the monitor mode is displayed (as "A002").

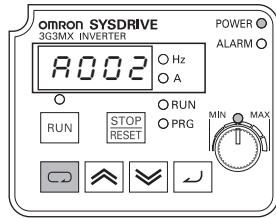

- Press the Enter key to fix the changed setting data.
- The RUN command source is changed to the control terminal, and the RUN command LED indicator will go off.
- You can now change to another extended function code.

↓ Press  .
(3 times)

5. The extended function mode is displayed (as "A---").

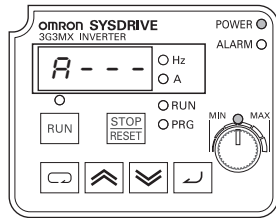

- You can now move to another extended function mode, the monitor mode, and the basic function mode.

Setting Function Codes

- You can enter codes for the monitor mode, basic function mode, and extended function mode directly, as well as through the scrolling method.
- Below is an example where code d001 of the monitor mode is changed to extended function A029.

1. Display the code of the monitor mode (as "d001").

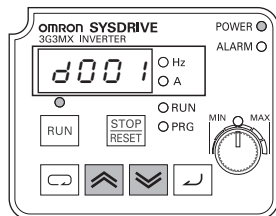

↓ Press  and  simultaneously.

(Continued to the next page)

2. Change the function code.

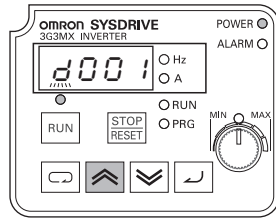

- You can change the 4th digit when "d" blinks.

↓ Press  .
(2 times)

("A001" is displayed.)

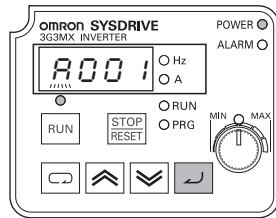

- "A" blinks.
- Press the Enter key to fix the blinking digit.

↓ Press  .
("A" is set.)

3. Change the 3rd digit of the function code.

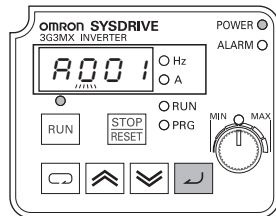

- "0" of the 3rd digit blinks.
- Press the Enter key to fix "0" of the 3rd digit as you need not change it.
- Press the Mode key to start "A" blinking again.

↓ Press  .
("0" is set.)

4. Change the 2nd digit of the function code.

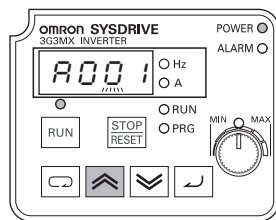

- "0" of the 2nd digit blinks.
- Press the Mode key to start "0" of the 3rd digit blinking again.

↓ Press  .
(2 times)

(Continued to the next page)

("A021" is displayed.)

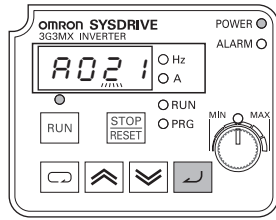

- "2" of the 2nd digit blinks.

↓ Press .

5. Change the 1st digit of the function code.

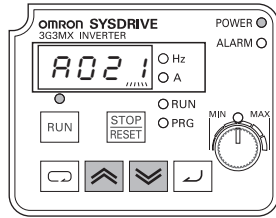

- "1" of the 1st digit blinks.
- Press the Mode key to start "0" of the 2nd digit blinking again.

↓ Press  or .
(2 times) (8 times)

("A029" is displayed.)

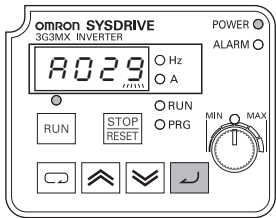

- "9" of the 1st digit blinks.

↓ Press .
("9" is set.)

6. The function code selection is complete.

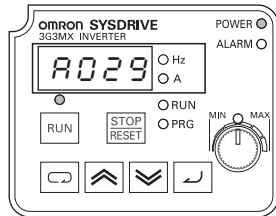







"A029" selection completed.

- Press the Mode key to change the data for A029.

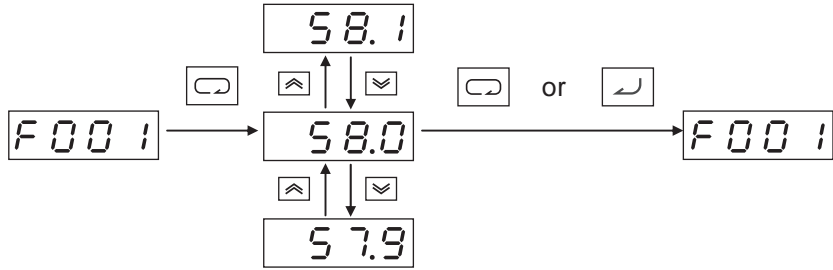
(Supplemental Information)

- If you enter a parameter number that is not included in the parameter list, the display returns to the parameter previously displayed.
- Press the Enter key to shift the digit to the right, and the Mode key to shift to the left.

3-5 Keys

	Name	Description
	Mode key	<p>Switches between the command setting and the data setting, and between the extended function mode and the basic function mode. With this key, you can always change the display as follows:</p> <p>[Supplemental Information] To jump to "d001" from any function mode, hold down the Mode key for 3 seconds.</p>  <p>Note: Always press the Enter key to store any changed data.</p>
	Increment key	Changes the set values, parameters, and commands.
	Decrement key	
	RUN key	Starts the operation. Forward/Reverse rotation depends on the "F004" setting.
	STOP/RESET key	Stops the operation. Functions as a reset key if an error occurs.
	Enter key	Enters and stores changed data. Do not press the Enter key if you don't want to store any changes, for example, if you change the data inadvertently.

3-6 Parameter Transition

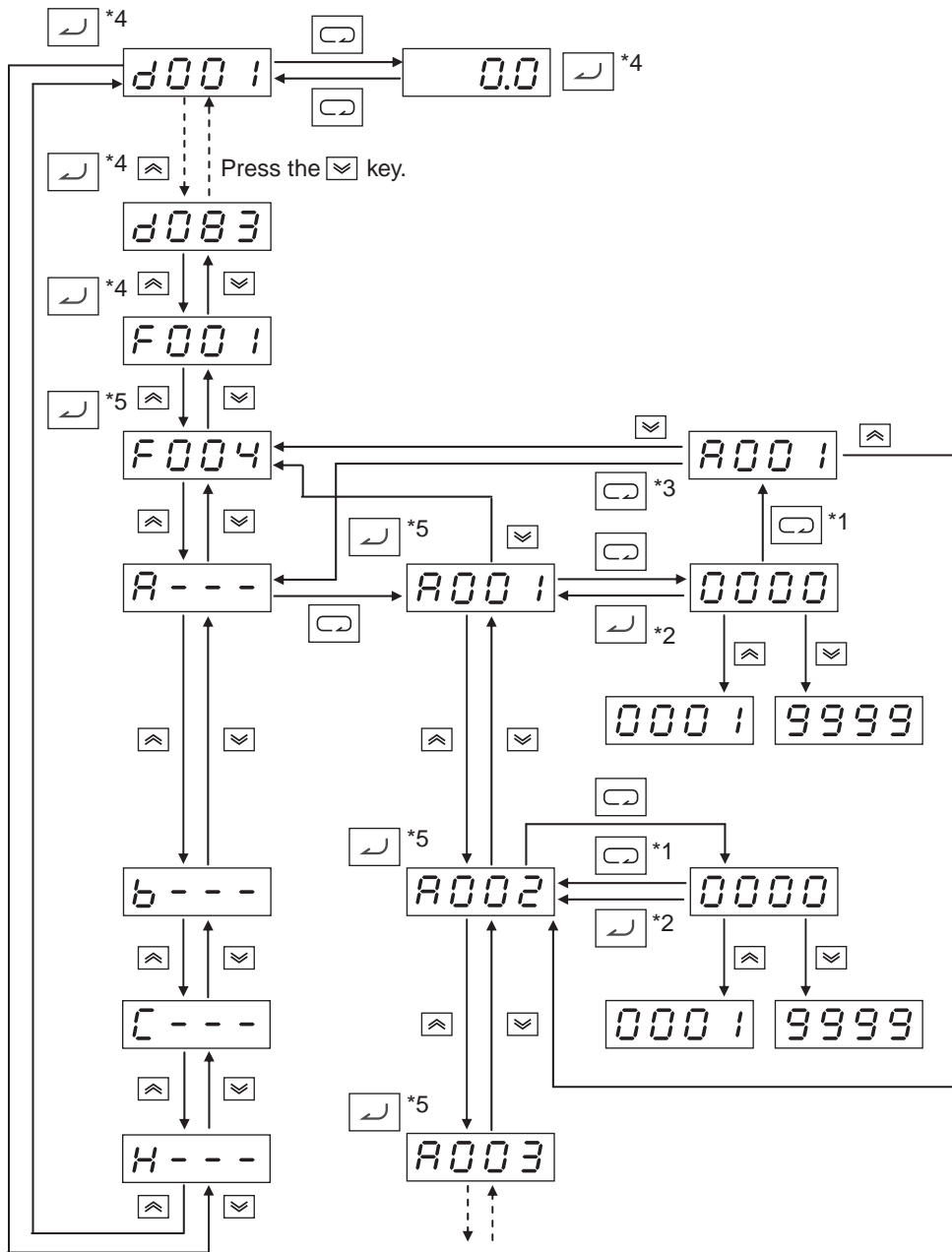

*1. Data is not stored by pressing the Mode key.

*2. Press the Enter key to store the data.

*3. When you press the Mode key after you return to the parameter number display without storing the data in the extended function mode, the mode selection function is selected.

*4. When you press the Enter key with `d***` or `F001` displayed, the monitor value is stored as the initial display that appears when the power is turned on.

*5. When you press the Enter key, the first digit of each parameter setting is stored as the initial display that appears when the power is turned on.

(Example: `F002`, `A---`, etc.)

- * To display a specific monitor when the power is turned on, press the Enter key with that monitor displayed. If a parameter for an extended function code is stored after pressing the Enter key, however, that code (A---, b---, C---, d---, or H---) appears at the next power-on. To prevent this, always press the Enter key again with the desired monitor displayed after storing a parameter.

3-7 Parameter List

Monitor Mode (d□□□) / Basic Function Mode (F□□□)

Parameter No.	Function name	Monitor or data range (Digital Operator)	Default setting	Changes during operation	Unit	Page
d001	Output frequency monitor	0.0 to 400.0	—	—	Hz	4-1
d002	Output current monitor	0.0 to 999.9	—	—	A	4-1
d003	Rotation direction monitor	F: Forward o: Stop r: Reverse	—	—	—	4-1
d004	PID feedback value monitor	0.00 to 99.99 100.0 to 999.9 1000. to 9999.	—	—	—	4-1
d005	Multi-function input monitor	<p>Example) Terminal S2, S1: ON Terminal S6, S5, S4, S3: OFF</p>	—	—	—	4-2
d006	Multi-function output monitor	<p>Example) Terminal P1, P2: ON Terminal MA: OFF</p>	—	—	—	4-2
d007	Output frequency monitor (after conversion)	0.00 to 99.99 100.0 to 999.9 1000. to 9999. 1000 to 3996 (10000 to 39960) (Output frequency × Conversion factor of b086)	—	—	—	4-2
d013	Output voltage monitor	0. to 600.	—	—	V	4-3
d016	Total RUN time	0. to 9999. 1000 to 9999 ┌100 to ┌999[h]	—	—	h	4-3
d017	Power ON time monitor	0. to 9999. 1000 to 9999 ┌100 to ┌999[h]	—	—	h	4-3
d080	Fault frequency monitor	0. to 9999.	—	—	—	4-3
d081	Fault monitor 1 (Latest)	Error code (condition of occurrence) → Output frequency [Hz] → Output current [A] → Internal DC voltage [V] → RUN time [h] → ON time [h]	—	—		4-3
d082	Fault monitor 2					
d083	Fault monitor 3					
F001	Output frequency setting/monitor	0.0/Starting frequency to 400.0	—	Yes	Hz	4-5

*2nd control is displayed when '08 (2nd control)' is allocated to one of multi-function inputs from C001 to C006.

Parameter No.	Function name	Monitor or data range (Digital Operator)	Default setting	Changes during operation	Unit	Page
F002	Acceleration time 1	0.01 to 99.99 100.0 to 999.9 1000. to 3000.	10.0	Yes	s	4-5
F202	* 2nd acceleration time 1	0.01 to 99.99 100.0 to 999.9 1000. to 3000.	10.0	Yes	s	4-5
F003	Deceleration time 1	0.01 to 99.99 100.0 to 999.9 1000. to 3000.	10.0	Yes	s	4-5
F203	* 2nd deceleration time 1	0.01 to 99.99 100.0 to 999.9 1000. to 3000.	10.0	Yes	s	4-5
F004	Operator rotation direction selection	00: Forward 01: Reverse	00	No	—	4-6

*2nd control is displayed when '08 (2nd control)' is allocated to one of multi-function inputs from C001 to C006.

Extended Function Mode

Parameter No.	Function name	Monitor or data range (Digital Operator)	Default setting	Changes during operation	Unit	Page	
Basic setting	A001	Frequency reference selection	00: Digital Operator (FREQ adjuster) 01: Terminal 02: Digital Operator (F001)	00	No	—	4-7 4-67
	A201	*2nd frequency reference selection	03: Modbus communication 10: Frequency operation result	00	No	—	4-7
	A002	RUN command selection	01: Terminal 02: Digital Operator 03: Modbus communication	02	No	—	4-8 4-67
	A202	*2nd RUN command selection		02	No	—	4-8
	A003	Base frequency	30. to Max. frequency [A004]	60.	No	Hz	4-8
	A203	*2nd base frequency	30 to Max. frequency [A204]	60.			
	A004	Maximum frequency	30. to 400.	60.	No	Hz	4-9
	A204	*2nd maximum frequency		60.			
Analog input	A005	FV/FI selection	00: Switches between FV/FI via terminal AT 01: Disabled (Outputs FV+FI) 02: Switches between FV/VR via terminal AT 03: Switches between FI/VR via terminal AT	00	No	—	4-10
	A011	FV start frequency	0.0 to Max. frequency	0.0	No	Hz	4-10
	A012	FV end frequency	0.0 to Max. frequency	0.0	No	Hz	4-10
	A013	FV start ratio	0. to 100.	0.	No	%	4-10
	A014	FV end ratio	0. to 100.	100.	No	%	4-10
	A015	FV start selection	00: External start frequency (A011 set value) 01: 0 Hz	01	No	—	4-10
	A016	FV, FI sampling	1. to 17.	8.	No	—	4-11

*2nd control is displayed when '08 (2nd control)' is allocated to one of multi-function inputs from C001 to C006.

Parameter No.	Function name	Monitor or data range (Digital Operator)	Default setting	Changes during operation	Unit	Page			
Multi-step speed, Jogging	A020	Multi-step speed reference 0	0.0/Starting frequency to Max. frequency	6.0	Yes	Hz			
	A220	*2nd multi-step speed reference 0	0.0/Starting frequency to 2nd max. frequency	6.0	Yes	Hz			
	A021	Multi-step speed reference 1	0.0/Starting frequency to Max. frequency	0.0	Yes	Hz			
	A022	Multi-step speed reference 2		0.0					
	A023	Multi-step speed reference 3		0.0					
	A024	Multi-step speed reference 4		0.0					
	A025	Multi-step speed reference 5		0.0					
	A026	Multi-step speed reference 6		0.0					
	A027	Multi-step speed reference 7		0.0					
	A028	Multi-step speed reference 8		0.0			Yes	Hz	4-42
	A029	Multi-step speed reference 9		0.0					
	A030	Multi-step speed reference 10		0.0					
	A031	Multi-step speed reference 11		0.0					
	A032	Multi-step speed reference 12		0.0					
	A033	Multi-step speed reference 13		0.0					
	A034	Multi-step speed reference 14		0.0					
	A035	Multi-step speed reference 15		0.0					
	A038	Jogging frequency	0.00/Starting frequency to 9.99	6.00	Yes	Hz	4-43		
	A039	Jogging stop selection	00: Free-run stop 01: Deceleration stop 02: DC injection braking stop	00	No	—	4-43		

*2nd control is displayed when '08 (2nd control)' is allocated to one of multi-function inputs from C001 to C006.

3-7 Parameter List

Parameter No.	Function name	Monitor or data range (Digital Operator)	Default setting	Changes during operation	Unit	Page
A042	Manual torque boost voltage	0.0 to 20.0	5.0	Yes	%	4-11
A242	*2nd manual torque boost voltage		0.0			
A043	Manual torque boost frequency	0.0 to 50.0	3.0	Yes	%	4-11
A243	*2nd manual torque boost frequency		0.0			
A044	V/f characteristics selection	00: Constant torque characteristics (VC) 01: Special reduced torque characteristics (Special VP) 02: Intelligent sensor-less vector control (iSLV)	02	No	—	4-12
A244	*2nd V/f characteristics selection		00			
A045	Output voltage gain	20. to 100.	100.	Yes	%	4-12 4-34 4-64
A245	*2nd output voltage gain		100.			4-12
A046	Automatic torque boost voltage compensation gain	0. to 255.	100.	Yes	%	4-13
A246	*2nd automatic torque boost voltage compensation gain		100.			
A047	Automatic torque boost slip compensation gain	0. to 255.	100.	Yes	%	4-13
A247	*2nd automatic torque boost slip compensation gain		100.			

*2nd control is displayed when '08 (2nd control)' is allocated to one of multi-function inputs from C001 to C006.

Parameter No.	Function name	Monitor or data range (Digital Operator)	Default setting	Changes during operation	Unit	Page	
DC injection braking	A051	DC injection braking selection	00: Disabled 01: Enabled	00	No	—	4-14
	A052	DC injection braking frequency	0.0 to 60.0	0.5	No	Hz	4-14
	A053	DC injection braking delay time	0.0 to 5.0	0.0	No	s	4-14
	A054	DC injection braking power	0. to 100.	50.	No	%	4-14
	A055	DC injection braking time	0.0 to 60.0	0.5	No	s	4-14
	A056	DC injection braking method selection	00: Edge operation 01: Level operation	01	No	—	4-14
Upper/Lower limit, Jump	A061	Frequency upper limit	0.0/Frequency lower limit to Max. frequency	0.0	No	Hz	4-17
	A261	*2nd frequency upper limit	0.0/Frequency lower limit to 2nd Max. frequency	0.0			
	A062	Frequency lower limit	0.0/Starting frequency to Frequency upper limit	0.0	No	Hz	4-17
	A262	*2nd frequency lower limit	0.0/Starting frequency to 2nd frequency upper limit	0.0			
	A063	Jump frequency 1	Jump frequency: 0.0 to 400.0 Jump frequency width: 0.0 to 10.0	0.0	No	Hz	4-18
	A064	Jump frequency width 1		0.5			
	A065	Jump frequency 2		0.0			
	A066	Jump frequency width 2		0.5			
A067	Jump frequency 3	0.0					
A068	Jump frequency width 3	0.5					

*2nd control is displayed when '08 (2nd control)' is allocated to one of multi-function inputs from C001 to C006.

3-7 Parameter List

Parameter No.	Function name	Monitor or data range (Digital Operator)	Default setting	Changes during operation	Unit	Page	
PID control	A071	PID selection	00: Disabled 01: Enabled	00	No	—	4-18
	A072	PID P gain	0.2 to 5.0	1.0	Yes	—	4-18
	A073	PID I gain	0.0 to 150.0	1.0	Yes	s	4-18
	A074	PID D gain	0.00 to 100.0	0.0	Yes	s	4-18
	A075	PID scale	0.01 to 99.99	1.00	No	Time	4-18
	A076	PID feedback selection	00: FI 01: FV 02: RS485 communication 10: Operation function output	00	No	—	4-18
	A077	Reverse PID function	00: OFF (Deviation = Target value - Feedback value) 01: ON (Deviation = Feedback value - Target value)	00	No	—	4-18
	A078	PID output limit function	0.00 to 100.0	0.0	No	%	4-18
AVR	A081	AVR selection	00: Always ON 01: Always OFF 02: OFF during deceleration	02	No	—	4-21
	A082	AVR voltage selection	200-V class: 200/215/220/230/240 400-V class: 380/400/415/440/460/480	200/ 400	No	V	4-21

*2nd control is displayed when '08 (2nd control)' is allocated to one of multi-function inputs from C001 to C006.

Parameter No.	Function name	Monitor or data range (Digital Operator)	Default setting	Changes during operation	Unit	Page		
RUN mode, Acceleration/Deceleration functions	A092	Acceleration time 2	0.01 to 99.99 100.0 to 999.9	15.00	Yes	s	4-22	
	A292	*2nd acceleration time 2	1000. to 3000.	15.00				
	A093	Deceleration time 2	0.01 to 99.99 100.0 to 999.9	15.00	Yes	s	4-22	
	A293	*2nd deceleration time 2	1000. to 3000.	15.00				
	A094	2-step acceleration/ deceleration selection	00: Switched via multi-function input 09 (2CH) 01: Switched by setting	00	No	—	4-22	
	A294	*2nd 2-step acceleration/ deceleration selection		00				
	A095	2-step acceleration frequency	0.0 to 400.0	0.0	No	Hz	4-22	
	A295	*2nd 2-step acceleration frequency		0.0				
	A096	2-step deceleration frequency	0.0 to 400.0	0.0	No	Hz	4-22	
	A296	*2nd 2-step deceleration frequency		0.0				
	A097	Acceleration pattern selection	00: Line 01: S-shape curve	00	No	—	4-23	
	A098	Deceleration pattern selection	00: Line 01: S-shape curve	00	No	—	4-23	
	External frequency adjustment	A101	FI start frequency	0.0 to 400.0	0.0	No	Hz	4-10
		A102	FI end frequency	0.0 to 400.0	0.0	No	Hz	4-10
		A103	FI start ratio	0. to 100.	0.	No	%	4-10
		A104	FI end ratio	0. to 100.	100.	No	%	4-10
A105		FI start selection	00: Use FI start frequency [A101] 01: 0 Hz start	01	No	—	4-10	

*2nd control is displayed when '08 (2nd control)' is allocated to one of multi-function inputs from C001 to C006.

3-7 Parameter List

Parameter No.	Function name	Monitor or data range (Digital Operator)	Default setting	Changes during operation	Unit	Page	
Operation frequency	A141	Operation frequency input A setting	00: Digital Operator (F001) 01: Digital Operator (FREQ adjuster) 02: Input FV	02	No	—	4-23
	A142	Operation frequency input B setting	03: Input FI 04: RS485 communication	03	No	—	4-23
	A143	Operator selection	00: Addition (A + B) 01: Subtraction (A - B) 02: Multiplication (A × B)	00	No	—	4-23
Frequency addition	A145	Frequency addition amount	0.0 to 400.0	0.0	Yes	Hz	4-24
	A146	Frequency addition direction	00: Adds A145 value to output frequency 01: Subtract A145 value from output frequency	00	No	—	4-24
VR adjustment	A151	VR start frequency	0.0 to 400.0	0.0	No	Hz	4-10
	A152	VR end frequency	0.0 to 400.0	0.0	No	Hz	4-10
	A153	VR start ratio	0. to 100.	0.	No	%	4-10
	A154	VR end ratio	0. to 100.	100.	No	%	4-10
	A155	VR start selection	00: Use start frequency [A151] 01: 0 Hz start	01	No	—	4-10
Restart after momentary power interruption	b001	Retry selection	00: Alarm 01: 0 Hz start 02: Frequency matching start 03: Trip after frequency matching deceleration stop	00	No	—	4-25
	b002	Allowable momentary power interruption time	0.3 to 25.0	1.0	No	s	4-25
	b003	Retry wait time	0.3 to 100.0	1.0	No	s	4-25 4-35
	b004	Momentary power interruption/ undervoltage trip during stop selection	00: Disabled 01: Enabled	00	No	—	4-25
	b005	Momentary power interruption retry time selection	00: 16 times 01: No limit	00	No	—	4-25

*2nd control is displayed when '08 (2nd control)' is allocated to one of multi-function inputs from C001 to C006.

Parameter No.	Function name	Monitor or data range (Digital Operator)	Default setting	Changes during operation	Unit	Page	
Electronic thermal	b012	Electronic thermal level	0.2 x Rated current to 1.2 x Rated current	Rated current	No	A	4-27
	b212	*2nd electronic thermal level		Rated current			
	b013	Electronic thermal characteristics selection	00: Reduced torque characteristics 1 01: Constant torque characteristics 02: Reduced torque characteristics 2	00	No	—	4-27
	b213	*2nd electronic thermal characteristics selection		00			
Overload limit	b021	Overload limit selection	00: Disabled 01: Enabled in acceleration/constant speed operation 02: Enabled in constant speed operation	01	No	—	4-29
	b221	*2nd overload limit selection		01			
	b022	Overload limit level	0.1 x Rated current to 1.5 x Rated current	1.5 x Rated current	No	A	4-29
	b222	*2nd overload limit level		1.5 x Rated current			
	b023	Overload limit parameter	0.1 to 3000.0	1.0	No	s	4-29
	b223	*2nd overload limit parameter		1.0			
	b028	Overload limit source selection	00: b022, b222 set values 01: Input terminal FV	00	No	—	4-29
	b228	*2nd overload limit source selection		00			
Lock	b031	Soft lock selection	00: Data other than b031 cannot be changed when terminal SFT is ON. 01: Data other than b031 and the specified frequency parameter cannot be changed when terminal SFT is ON. 02: Data other than b031 cannot be changed. 03: Data other than b031 and the specified frequency parameter cannot be changed. 10: Data other than parameters changeable during operation cannot be changed.	01	No	—	4-30
Others	b080	AM adjustment	0. to 255. (Shared with C086 for AM offset adjustment)	100.	Yes	—	4-31 4-63
	b082	Starting frequency	0.5 to 9.9	0.5	No	Hz	4-31
	b083	Carrier frequency	2.0 to 14.0	5.0	No	kHz	4-32 4-34 4-64

*2nd control is displayed when '08 (2nd control)' is allocated to one of multi-function inputs from C001 to C006.

3-7 Parameter List

Parameter No.	Function name	Monitor or data range (Digital Operator)	Default setting	Changes during operation	Unit	Page
Initialization	b084	Initialization selection 00: Clears the trip monitor 01: Initializes data 02: Clears the trip monitor and initializes data	00	No	—	4-32
	b085	Initialization parameter selection 00 * Do not change.	00	No	—	4-32
Others	b086	Frequency conversion coefficient 0.1 to 99.9	1.0	Yes	—	4-35
	b087	STOP key selection 00: Enabled 01: Disabled	00	No	—	4-35
	b088	Free-run stop selection 00: 0 Hz start 01: Frequency pull-in restart	00	No	—	4-35
	b090	Usage rate of regenerative braking function 0.0 to 100.0	0.0	No	%	4-37
	b091	Stop selection 00: Deceleration → Stop 01: Free-run stop	00	No	—	4-35
	b092	Cooling fan control 00: Always ON 01: ON during RUN 02: Depends on the fin temperature	01	No	—	4-36
	b095	Regenerative braking function operation selection 00: Disabled 01: Enable (Disable during stop) 02: Enable (Enable during stop)	0.0	No	—	4-37
	b096	Regenerative braking function ON level 200-V class: 330 to 380 400-V class: 660 to 760	200-V class: 360 V 400-V class: 720 V	No	V	4-37
	b130	Overvoltage LAD stop function 00: Disabled 01: Enabled	00	No	—	4-38
	b131	Overvoltage LAD stop function level setting 200-V class: 330. to 395. 400-V class: 660. to 790.	200-V class: 380 V 400-V class: 760 V	Yes	V	4-38
	b140	Overcurrent suppression function 00: Disabled 01: Enabled	00	No	—	4-39
	b150	Automatic carrier reduction 00: Disabled 01: Enabled	00	No	—	4-39
	b151	Ready function selection 00: Disabled 01: Enabled	00	No	—	4-40

*2nd control is displayed when '08 (2nd control)' is allocated to one of multi-function inputs from C001 to C006.

Parameter No.	Function name	Monitor or data range (Digital Operator)	Default setting	Changes during operation	Unit	Page
Multi-function input terminals	C001	Multi-function input 1 selection	00: FW (forward) 01: RV (reverse)	No	—	4-41
	C201	*2nd multi-function input 1 selection	02: CF1 (multi-step speed binary 1) 03: CF2 (multi-step speed binary 2) 04: CF3 (multi-step speed binary 3)			
	C002	Multi-function input 2 selection	05: CF4 (multi-step speed binary 4) 06: JG (jogging) 07: DB (external DC injection braking)			
	C202	*2nd multi-function input 2 selection	08: SET (2nd control) 09: 2CH (2-step acceleration/deceleration)			
	C003	Multi-function input 3 selection	11: FRS (free-run stop) 12: EXT (external trip) 13: USP (USP function)			
	C203	*2nd multi-function input 3 selection	15: SFT (soft lock) 16: AT (analog input switching) 18: RS (reset)			
	C004	Multi-function input 4 selection	19: PTC (thermistor input) 20: STA (3-wire start)			
	C204	*2nd multi-function input 4 selection	21: STP (3-wire stop) 22: F/R (3-wire forward/reverse) 23: PID (PID enabled/disabled)			
	C005	Multi-function input 5 selection	24: PIDC (PID integral reset) 27: UP (UP/DWN function accelerated)			
	C205	*2nd multi-function input 5 selection	28: DWN (UP/DWN function decelerated) 29: UDC (UP/DWN function data clear) 31: OPE (forced operator)			
	C006	Multi-function input 6 selection	50: ADD (frequency addition) 51: F-TM (forced terminal block)			
	C206	*2nd multi-function input 6 selection	52: RDY (ready function) 53: SP-SET (special setting) 255: No function			
C011	Multi-function input 1 operation selection	00: NO 01: NC	00	No	—	
C012	Multi-function input 2 operation selection		00			
C013	Multi-function input 3 operation selection		00			
C014	Multi-function input 4 operation selection		00			
C015	Multi-function input 5 operation selection		00			
C016	Multi-function input 6 operation selection		00			

*2nd control is displayed when '08 (2nd control)' is allocated to one of multi-function inputs from C001 to C006.

3-7 Parameter List

Parameter No.	Function name	Monitor or data range (Digital Operator)	Default setting	Changes during operation	Unit	Page	
Multi-function output setting	C021	Multi-function output terminal P1 selection	00	No	—	4-53	
	C022	Multi-function output terminal P2 selection	01				
	C026	Relay output (MA, MB) function selection	05				
	C028	AM selection	00: Output frequency 01: Output current	00	No	—	4-31 4-63
	C031	Multi-function output terminal P1 contact selection	00: NO contact at MA; NC contact at MB 01: NC contact at MA; NO contact at MB	00	No	—	4-61
	C032	Multi-function output terminal P2 contact selection		00			
	C036	Relay output (MA, MB) contact selection		01			
Level output status setting	C041	Overload warning level	Rated current	No	A	4-29 4-55	
	C241	*2nd overload warning level	Rated current			4-29	
	C042	Arrival frequency during acceleration	0.0 to 400.0	0.0	No	Hz	4-54
	C043	Arrival frequency during deceleration	0.0 to 400.0	0.0	No	Hz	4-54
	C044	PID deviation excessive level	0.0 to 100.0	3.0	No	%	4-19 4-56
	C052	PID FB upper limit	0.0 to 100.0	100.0	No	%	4-19
	C053	PID FB lower limit		0.0			

*2nd control is displayed when '08 (2nd control)' is allocated to one of multi-function inputs from C001 to C006.

Parameter No.	Function name	Monitor or data range (Digital Operator)	Default setting	Changes during operation	Unit	Page	
Communication function adjustment	C071	Communication speed selection (Baud rate selection)	04: 4800 bps 05: 9600 bps 06: 19200 bps	04	No	—	4-67
	C072	Communication station No. selection	1. to 32.	1.	No	—	4-67
	C074	Communication parity selection	00: No parity 01: Even 02: Odd	00	No	—	4-67
	C075	Communication stop bit selection	1: 1 bit 2: 2 bits	1	No	—	4-67
	C076	Communication error selection	00: Trip 01: Trip after deceleration stop 02: Ignore 03: Free run 04: Deceleration stop	02	No	—	4-67
	C077	Communication error timeout	0.00 to 99.99	0.00	No	s	4-67
	C078	Communication wait time	0. to 1000.	0	No	ms	4-67
	Various adjustment	C081	FV adjustment	0.0 to 200.0	100.0	Yes	%
C082		FI adjustment	0.0 to 200.0	100.0	Yes	%	4-34
C085		Thermistor adjustment	0.0 to 200.0 (For the external thermistor gain adjustment)	100.0	Yes	%	—
C086		AM offset adjustment	0.0 to 10.0	0.0	Yes	V	4-31 4-63

*2nd control is displayed when '08 (2nd control)' is allocated to one of multi-function inputs from C001 to C006.

3-7 Parameter List

Parameter No.	Function name	Monitor or data range (Digital Operator)	Default setting	Changes during operation	Unit	Page
C091	Not used	Use "00". * Do not change.	00	—	—	—
C101	UP/DWN selection	00: Do not store the frequency data 01: Store the frequency data	00	No	—	4-50
C102	Reset selection	00: Trip reset at power-on 01: Trip reset when the power is OFF 02: Enabled only during trip (Reset when the power is ON.)	00	No	—	4-48
C141	Logic operation function A input	00: RUN (signal during RUN) 01: FA1 (constant speed arrival signal) 02: FA2 (over set frequency arrival signal) 03: OL (overload warning) 04: OD (excessive PID deviation)	00	No	—	4-60
C142	Logic operation function B input	05: AL (alarm output) 06: Dc (disconnection detected) 07: FBV (PID FB value fault) 08: NDc (network error)	01	No	—	4-60
C143	Logic operator selection	00: AND 01: OR 02: XOR	00	No	—	4-60
C144	Output terminal P1 ON delay	0.0 to 100.0	0.0	No	s	4-61
C145	Output terminal P1 OFF delay	0.0 to 100.0	0.0	No	s	4-61
C146	Output terminal P2 ON delay	0.0 to 100.0	0.0	No	s	4-61
C147	Output terminal P2 OFF delay	0.0 to 100.0	0.0	No	s	4-61
C148	Relay output ON delay	0.0 to 100.0	0.0	No	s	4-61
C149	Relay output OFF delay	0.0 to 100.0	0.0	No	s	4-61

*2nd control is displayed when '08 (2nd control)' is allocated to one of multi-function inputs from C001 to C006.

Parameter No.	Function name	Monitor or data range (Digital Operator)	Default setting	Changes during operation	Unit	Page	
Control parameter	H003	Motor capacity selection	Factory default	No	kW	4-64	
	H203	*2nd motor capacity selection	Factory default				
	H004	Motor pole number selection	2 4 6 8	4	No	Pole	4-64
	H204	*2nd motor pole number selection	4				
	H006	Stabilization parameter	0. to 255.	100	Yes	%	4-34 4-64
	H206	* 2nd stabilization parameter		100			
	H007	Motor voltage selection	00: 200 V 01: 400 V	Factory default	Yes	%	4-64
	H207	*2nd motor voltage selection	Factory default				

*2nd control is displayed when '08 (2nd control)' is allocated to one of multi-function inputs from C001 to C006.

Chapter 4

Functions

4-1	Monitor Mode.....	4-1
4-2	Function Mode.....	4-5

4-1 Monitor Mode

Output Frequency Monitor [d001]

Displays the output frequency of the Inverter.
The monitor LED indicator "Hz" lights up while d001 is displayed.

(Display)

0.0 to 400.0: Displays in increments of 0.1 Hz.

Output Current Monitor [d002]

Displays the output current value of the Inverter.
The monitor LED indicator "A" lights up while d002 is displayed.

(Display)

0.0 to 999.9: Displays in increments of 0.1 A.

Rotation Direction Monitor [d003]

Displays whether the Inverter output is in a forward/reverse/stop status. The RUN LED indicator lights up during forward/reverse rotation.

(Display)

F: Forward

o: Stop

r: Reverse

PID Feedback Value Monitor [d004]

Displays a feedback value converted by [A075] (PID scale) when the PID function is enabled ([A071] = 01).

"Monitor display" = "PID feedback value (%)" × "PID scale"
[A075]

(Setting)

A071: 01 (PID enabled)

A075: 0.01 to 99.99 (Can be set in increments of 0.01.)

(Display)

0.00 to 99.99 : Displays in increments of 0.01.

100.0 to 999.9 : Displays in increments of 0.1.

1000 to 9999 : Displays in increments of 1.

Multi-function Input Monitor [d005]

Displays the input status of the multi-function input terminals.
C011 to C016 (contact selection) are excluded.

(Example) Multi-function input terminal S2,S1:ON
Multi-function input terminal S6,S5,S4,S3:OFF

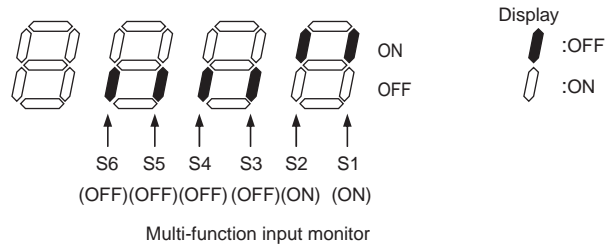

Multi-function Output Monitor [d006]

Displays the output status of the multi-function output terminals and relay output terminals.
C031, C032, and C036 (contact selection) are excluded.

This monitor indicates the signal status of the functions (C021 and C022) allocated to each multi-function output terminal.

(Example) Multi-function output terminal P2,P1:ON
Relay output terminal MA:OFF

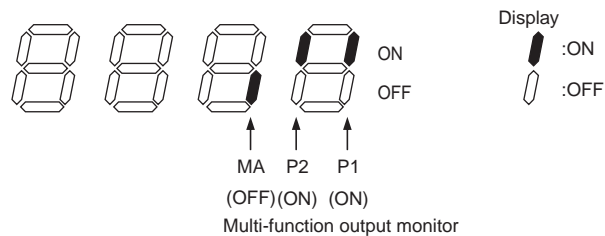

Output Frequency Monitor (After Conversion) [d007]

Displays a conversion value obtained by multiplying the Inverter output frequency by the coefficient set in [b086].

Displayed value = "Output frequency [d001]" × "Frequency conversion coefficient [b086]"

(Display) [d007]

- 0.00 to 99.99 : Displays in increments of 0.01.
- 100.0 to 999.9 : Displays in increments of 0.1.
- 1000. to 9999. : Displays in increments of 1.
- 1000 to 3996 : Displays in increments of 10.

(Setting range) [b086]

0.1 to 99.9: Can be set in increments of 0.1.

(Example)

When the output frequency [d001] = 50.0 Hz, and the frequency conversion coefficient [b086] = 1.1, the monitor [d007] displays "55.0" through $50.0 \times 1.1 = 55.0$.

Output Voltage Monitor [d013]

Displays the output voltage value (Vac) of the Inverter.
The monitor LED indicator "V" lights up.

(Display)

0. to 600.: Displays in increments of 1 V.

Total RUN Time [d016]

Displays the Inverter RUN time.

(Display)

0. to 9999. : Displays in increments of 1 hour.

1000 to 9999 : Displays in increments of 10 hours.

┌100 to ┌999 : Displays in increments of 1000 hours.

Power ON Time Monitor [d017]

Displays the total power ON time of the Inverter.

(Display)

0. to 9999. : Displays in increments of 1 hour.

1000 to 999 : Displays in increments of 10 hours.

┌100 to ┌999 : Displays in increments of 1000 hours.

Fault Frequency Monitor [d080]

•Displays the number of times the Inverter has tripped.

(Display)

0. to 9999. : Displays in increments of 1 time.

1000 to 6553 : Displays in increments of 10 times.

Fault Monitors 1 [d081], 2 [d082], 3 [d083]

•Displays the details of the last three trips.
The most recent trip is displayed on trip monitor 1.

(Display)

•Factor (E01 to E35)*1

•Output frequency at the time of tripping (Hz)

•Output current at the time of tripping (A)

•Internal DC voltage at the time of tripping (V)

•Total RUN time before the trip (hr)

•Total power supply time before the trip (hr)

*1. Refer to "Error Code List" (page 5-1) or "Trip Monitor Display" (page 5-4).

(Trip Monitor Display Sequence)

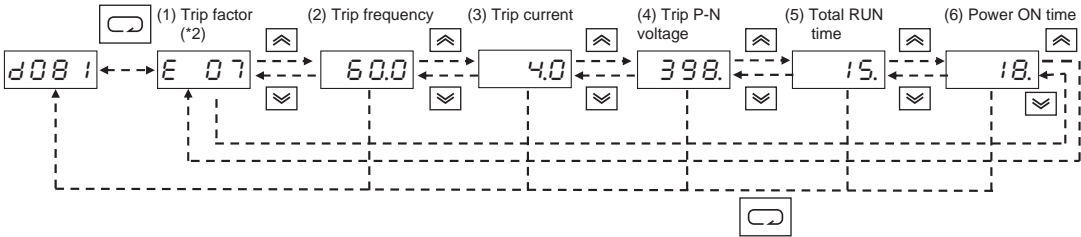

*2. Displays if there has been no trip.

4-2 Function Mode

<Group F: Basic Function Parameter>

Output Frequency Setting/Monitor

- Set the Inverter output frequency.
- With the frequency reference set to the Digital Operator ([A001] = 02), you can set the output frequency in F001. For other methods, refer to the [A001] section in "Frequency Reference Selection" (page 4-7).
- If a frequency is set in [F001], the same value is automatically set in multi-step speed reference 0 [A020]. To set the 2nd multi-step speed reference, use [A220], or use [F001] with the SET terminal turned on.
To set by using the SET terminal, allocate 08 (SET) to the desired multi-function input terminal.

Parameter No.	Function name	Data	Default setting	Unit
F001	Output frequency setting/monitor	0.0, Starting frequency to Max. frequency	—	Hz
A020	Multi-step speed reference 0		6.0	
A220	*2nd multi-step speed reference 0			
Related functions		A001, A201, C001 to C006		

* To switch to the 2nd multi-step speed, allocate 08 (SET) to the multi-function input and then turn it on.

Acceleration/Deceleration Time

- Set an acceleration/deceleration time for the motor. For a slow transition, set to a large value, and for a fast transition, set to a small one.

Parameter No.	Function name	Data	Default setting	Unit
F002	Acceleration time 1	0.01 to 3000	10.0	s
F202	*2nd acceleration time 1			
F003	Deceleration time 1			
F203	*2nd deceleration time 1			
Related functions		A004, A204, C001 to C006		

* To switch to 2nd acceleration/deceleration time 1, allocate 08 (SET) to the multi-function input and then turn it on.

- The set time here indicates the acceleration/deceleration time from 0 Hz to the maximum frequency.

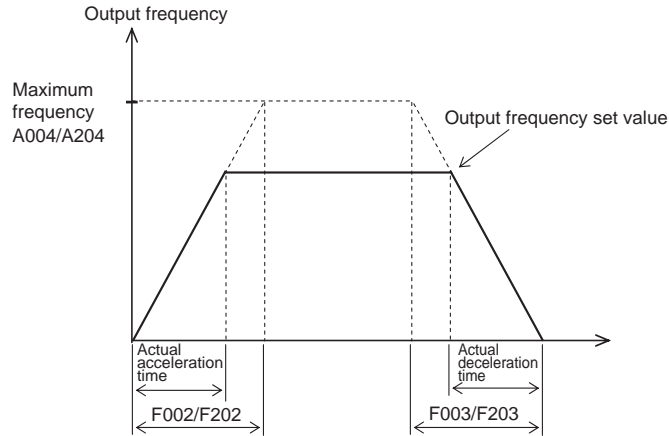

Even if a short acceleration/deceleration time is set, the actual time cannot be shorter than the minimum acceleration/deceleration time that is determined by the mechanical inertia moment and the motor torque. If you set a time shorter than the minimum time, an overcurrent/overvoltage trip may occur.

Acceleration Time T_s

$$T_s = \frac{(J_L + J_M) \times N_M}{9.55 \times (T_S - T_L)}$$

J_L :Inertia moment of the load converted to the motor shaft [kg·m²]

J_M :Inertia moment of the motor [kg·m²]

N_M :Motor rotation speed [r/min]

T_S :Maximum acceleration torque with the Inverter driving [N·m]

Deceleration Time T_B

T_B :Maximum deceleration torque with the Inverter driving [N·m]

T_L :Required driving torque [N·m]

$$T_B = \frac{(J_L + J_M) \times N_M}{9.55 \times (T_B + T_L)}$$

For short-time deceleration, use the regenerative braking unit (optional).

Digital Operator Rotation Direction Selection

Select the direction of motor rotation applied to the RUN command via the Digital Operator. This is disabled at terminals.

Parameter No.	Function name	Data	Default setting	Unit
F004	Operator rotation direction selection	00: Forward 01: Reverse	00	—

<Group A: Standard Function Parameter>**Frequency Reference Selection**

Select the method for using the frequency reference.

Parameter No.	Function name	Data	Default setting	Unit
A001	Frequency reference selection	00: Digital Operator (FREQ adjuster) 01: Terminal	00	—
A201	*2nd frequency reference selection	02: Digital Operator (F001) 03: ModBus communication 10: Frequency operation result		
Related functions		A005, A141 to A143, A145, A146		

* To switch to the 2nd frequency reference, allocate 08 (SET) to the multi-function input and then turn it on.

Data	Frequency reference source
00	FREQ adjuster
01	Voltage or current directive from the terminal
02	F001 value set via the Digital Operator
03	ModBus communication
10	Result of the frequency operation function

RUN Command Selection

Select the method for using the RUN/STOP command.

Parameter No.	Function name	Data	Default setting	Unit
A002	RUN command selection	01: Terminal 02: Digital Operator 03: ModBus communication	02	—
A202	*2nd RUN command selection			
Related functions		F004, A002, C001 to C006		

* To switch to the 2nd RUN command, allocate 08 (SET) to the multi-function input and then turn it on.

Data	RUN command source
01	Turn on/off the FW and RV allocated to the terminal. The STOP command is activated if both Forward/Reverse commands are input simultaneously.
02	Use the STOP/RESET key on the Digital Operator.
03	Use the ModBus communication.

Base Frequency

■ Base Frequency and Motor Voltage

Match the Inverter output (frequency/voltage) to the motor rating. Be careful, especially if you set a base frequency at below 50 Hz. Otherwise, the motor may burn out.

Parameter No.	Function name	Data	Default setting	Unit
A003	Base frequency	30 to Max. frequency [A004]	60.0	Hz
A203	* 2nd base frequency	30 to Max. frequency [A204]		
Related functions		A004, A204, A081, A082		

* To switch to the 2nd base frequency, allocate 08 (SET) to the multi-function input and then turn it on.

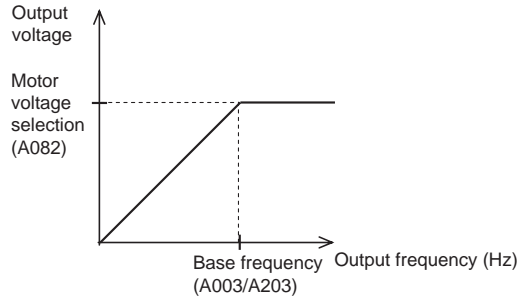

- If you apply a base frequency of over 60 Hz, a special motor is required. This may require the Inverter to increase its capacity to accommodate a different applicable motor.
- Select the motor voltage according to the motor specifications. If the voltage exceeds the specified level, the motor may burn out.
- The Inverter cannot output voltage beyond that of the incoming voltage.

Maximum Frequency

Set the maximum value of the output frequency.

- The value set here is the maximum value (e.g., 10 V in the range from 0 to 10 V) of the external analog input (frequency reference).
- The maximum Inverter output voltage from base to maximum frequencies is the voltage set in AVR voltage selection A082.
- The Inverter cannot output voltage beyond that of the incoming voltage.

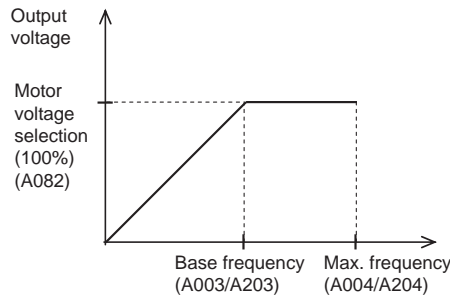

Parameter No.	Function name	Data	Default setting	Unit
A004	Maximum frequency	30 to 400	60.0	Hz
A204	* 2nd maximum frequency			
Related functions		A003, A203, A081, A082		

* To switch to the 2nd max. frequency, allocate 08 (SET) to the multi-function input and then turn it on.

Analog Input (FV, FI)

The Inverter has two types of analog input terminals.

FV-FC terminal: 0 to 10 V (voltage input)

FI-FC terminal: 4 to 20 mA (current input)

Simultaneous inputs are not acceptable. Do not connect the signal lines for inputs FV and FI simultaneously.

Parameter No.	Function name	Data	Default setting	Unit
A005	FV/FI selection	00: Switches between FV/FI via terminal AT 01: Operation via terminal AT is disabled 02: Switches between FV/FREQ adjuster via terminal AT 03: Switches between FI/FREQ adjuster via terminal AT	00	—
Related functions		A011 to A016, A101 to A105, A151 to A155, C001 to C006		

This function is enabled with the frequency reference set to the terminal block (A001 or A201 = 01). The settings are as follows. (VR: FREQ adjuster)

A005 set value	00		01	02		03	
AT terminal input status	OFF	ON	—	OFF	ON	OFF	ON
Analog input enabled	FV-FC	FI-FC	FV-FI	FV-FC	VR	FI-FC	VR

If AT is not allocated to any of the multi-function input, this means the AT input = OFF in the above table.

External Frequency (Voltage/Current) Adjustment

External Analog Input (Frequency Reference)

FV-FC terminal: 0 to 10 V (voltage input)

FI-FC terminal: 4 to 20 mA (current input)

Also set an output frequency for the FREQ adjuster on the Digital Operator.

Parameter No.	Function name	Data	Default setting	Unit
A011 A101 A151	FV/FI/VR start frequency	0.00 to 400.0 (Set start/end frequency.)	0.0	Hz
A012 A102 A152	FV/FI/VR end frequency			
A013 A103 A153	FV/FI/VR start ratio	0. to 100. (Set a start/end ratio relative to an external frequency reference of 0 to 10 V and 4 to 20 mA.)	0.	%
A014 A104 A154	FV/FI/VR end ratio		100.	
A015 A105 A155	FV/FI/VR start selection	00: Start frequency (A011 set value) 01: 0 Hz	01	—

Parameter No.	Function name	Data	Default setting	Unit
Related functions		A005, A016, AT input		

•To input voltage ranging from 0 to 5 V on the FV-FC terminal, set A014 to 50%.

(Example 1) A015/A105/A155: 00

(Example 2) A015/A105/A155: 01

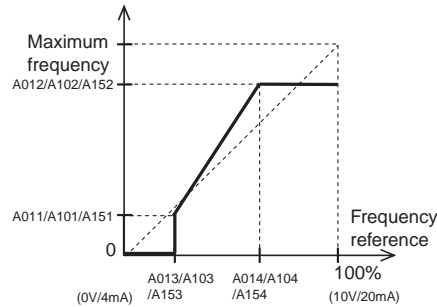
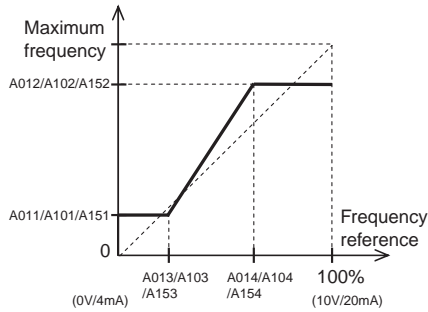

FV, FI Sampling

•You can set the built-in filter applied to frequency setting signals of the external voltage/current input.

Parameter No.	Function name	Data	Default setting	Unit
A016	FV, FI sampling	1. to 17.	8.	Time
Related functions		A011 to A016, C001 to C006		

- Helps remove noise in the frequency setting circuit.
- Set a larger data value if stable operation cannot be secured because of noise. Note that the larger the data value is, the slower the response time.
- In case of setting "17", it indicates the setting of 16 moving average calculation disregarding the voltage fluctuation equivalent to 0.1 Hz. Though the frequency becomes less likely to fluctuate, the resolution for analog input decreases. This setting is not suitable for equipment that requires rapid response.

Relation Between Torque Boost and V/f Characteristics

Determine the relation of output voltage against output frequency.

Parameter No.	Function name	Data	Default setting	Unit
A042	Manual torque boost voltage	0.0 to 20.0 (Ratio to the value of AVR voltage selection A082)	5.0	%
A242	* 2nd manual torque boost voltage		0.0	
A043	Manual torque boost frequency	0.0 to 50.0 (Ratio to base frequency)	3.0	%
A243	* 2nd manual torque boost frequency		0.0	

Parameter No.	Function name	Data	Default setting	Unit
A044	V/f characteristics selection	00: Constant torque characteristics (VC)	00	—
A244	* 2nd V/f characteristics selection	01: Special reduced torque characteristics (Special VP) 02: Intelligent sensorless vector control (iSLV)		
A045	Output voltage gain	20. to 100.		
A245	*2nd output voltage gain			
Related functions		A046, A246, A047, A247, A082, H003, H203, H004, H204		

* To switch to the 2nd control, allocate 08 (SET) to the multi-function input and then turn it on.

■ Control Method (V/f Characteristics)

Constant Torque Characteristics (VC)

- Output voltage is proportional to output frequency. While proportional from 0 Hz to base frequency, the output voltage is constant from base to maximum frequencies regardless of the frequency.

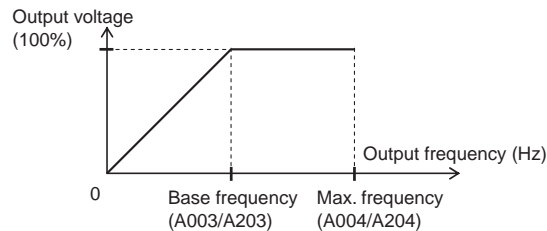

Special Reduced Torque Characteristics (Special VP)

- Suitable for a fan or pump that requires torque in a low speed range. These have VC characteristics only for low deceleration in reduced torque characteristics.

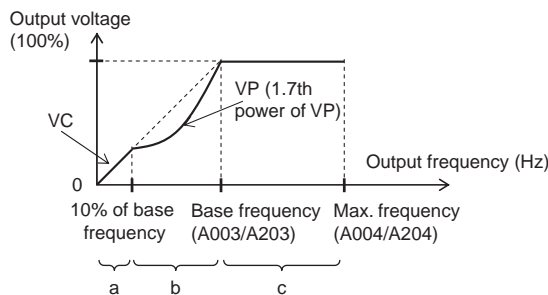

Period a: Provides constant torque characteristics (VC) within a range from 0 Hz to 10% of the base frequency.

(Example) If the base frequency is 60 Hz, the Inverter provides constant torque characteristics within a range from 0 to 6 Hz.

Period b: Provides reduced torque characteristics within a range from 10% to 100% of the base frequency.

The Inverter outputs voltage based on a curve of the 1.7th power of the frequency.

Period c: Provides constant voltage within a range from the base frequency to the maximum frequency.

■Torque Boost

- Compensates for the voltage drop caused by the motor primary resistance or by wiring and suppresses torque reduction at a low speed range.

Manual Torque Boost [A042/A242, A043/A243]

- Adds the voltage characteristics set in A042/A242 and A043/A243 to the V/f characteristics, and outputs the resulting voltage. The addition value is set in percentage terms based on the AVR voltage selection (A082) as 100%.
- The manual torque boost frequency (A043/A243) is set in percentage terms based on the base frequency as 100%.

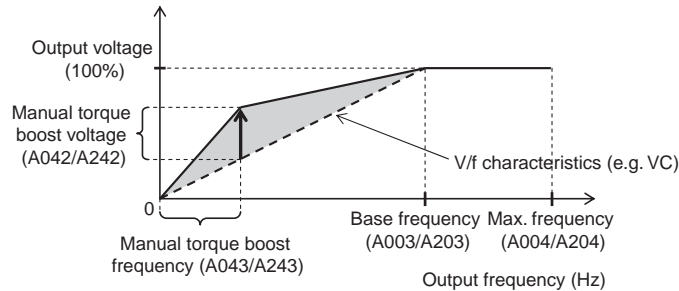

- If you raise the set value of the manual torque boost, be careful about motor overexcitation. Otherwise, the motor may burn out.
- Should such a situation occur, lower the set value of A042/A242.

Manual + Automatic Torque Boost (Intelligent Sensorless Vector Control)

- Automatically adjusts output voltage and output frequency according to the load status.
- To avoid a possible overcurrent trip during deceleration, set the AVR selection to "Always ON" (A081: 00).
- Sufficient characteristics may not be obtained if you select two or more lower rank motor size than specified.

Phenomenon	Adjusting method	Adjustment item
Insufficient torque at low speed (Motor does not run at low speed.)	Gradually increase the voltage setting of the manual torque boost.	A042/A242
	Gradually increase the slip compensation gain of the automatic torque boost.	A047/A247
	Gradually increase the voltage compensation gain of the automatic torque boost.	A046/A246
	Reduce the set value of the carrier frequency.	b083
Rotation speed lowers when load is applied.	Gradually increase the slip compensation gain of the automatic torque boost.	A047/A247
Rotation speed increases when load is applied.	Gradually reduce the slip compensation gain of the automatic torque boost.	A047/A247
Overcurrent trip occurs when load is applied.	Gradually reduce the voltage compensation gain of the automatic torque boost.	A046/A246
	Gradually reduce the slip compensation gain of the automatic torque boost.	A047/A247
	Gradually reduce the voltage setting of the manual torque boost.	A042/A242

■ Output Voltage Gain

- Changes the Inverter output voltage in percentages, with the voltage selected in the AVR voltage selection (A082) as 100%.
- The Inverter cannot output voltage beyond that of the input voltage.

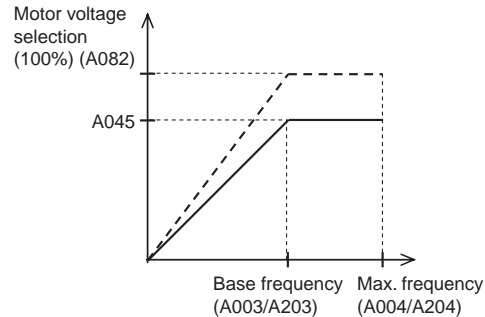

DC Injection Braking (DB)

This function securely stops the motor rotation during deceleration.

Parameter No.	Function name	Data	Default setting	Unit
A051	DC injection braking selection	00: Disabled 01: Enabled	00	—
A052	DC injection braking frequency	0.0 to 60.0	0.5	Hz
A053	DC injection braking delay time	0.0 to 5.0	0.0	s
A054	DC injection braking power	0. to 100.	50	%
A055	DC injection braking time	0.0 to 60.0	0.5	s
A056	DC injection braking method selection	00: Edge operation 01: Level operation	01	—
Related functions		C001 to C006		

- Two methods are available for DC injection braking: One is the external method via the multi-function input (external DC injection braking); the other is the internal method performed automatically to stop the motor (internal DC injection braking).
- Below are operation types:
 - Edge operation: DB operates during the specified time period from the DB signal input.
 - Level operation: DB operates while a signal is being input.
 - Frequency control mode: DB operates when the frequency reaches the specified level during operation.
- If DC injection braking operates at a high motor speed, an overcurrent trip (E01 to E04) or overload trip (E05) may occur. For internal DC injection braking, the following adjustment may help you avoid such a situation:
 - Lower the DC injection braking frequency (A052).
 - Increase the DC injection braking delay time (A053)

For external DC injection braking via the multi-function input, use the external DC injection braking terminal (along with deceleration stop).

• External DC Injection Braking (A051 = 00)

- Allocate 07 (DB) to the desired multi-function input.
- DC injection braking can be applied by turning on/off the DB terminal, regardless of the DC injection braking selection (A051).
- Adjust the DC injection braking power with A054.
- If the DC injection braking delay time (A053) is set, the Inverter output will be shut off during the specified time period and the motor goes into free-run status. After the set time elapses, DC injection braking starts.
- Set the DC injection braking time (A055) via the Digital Operator or the DB terminal while taking into account motor heat generation.
- Perform each setting according to your system after selecting the level or edge operation in A056.

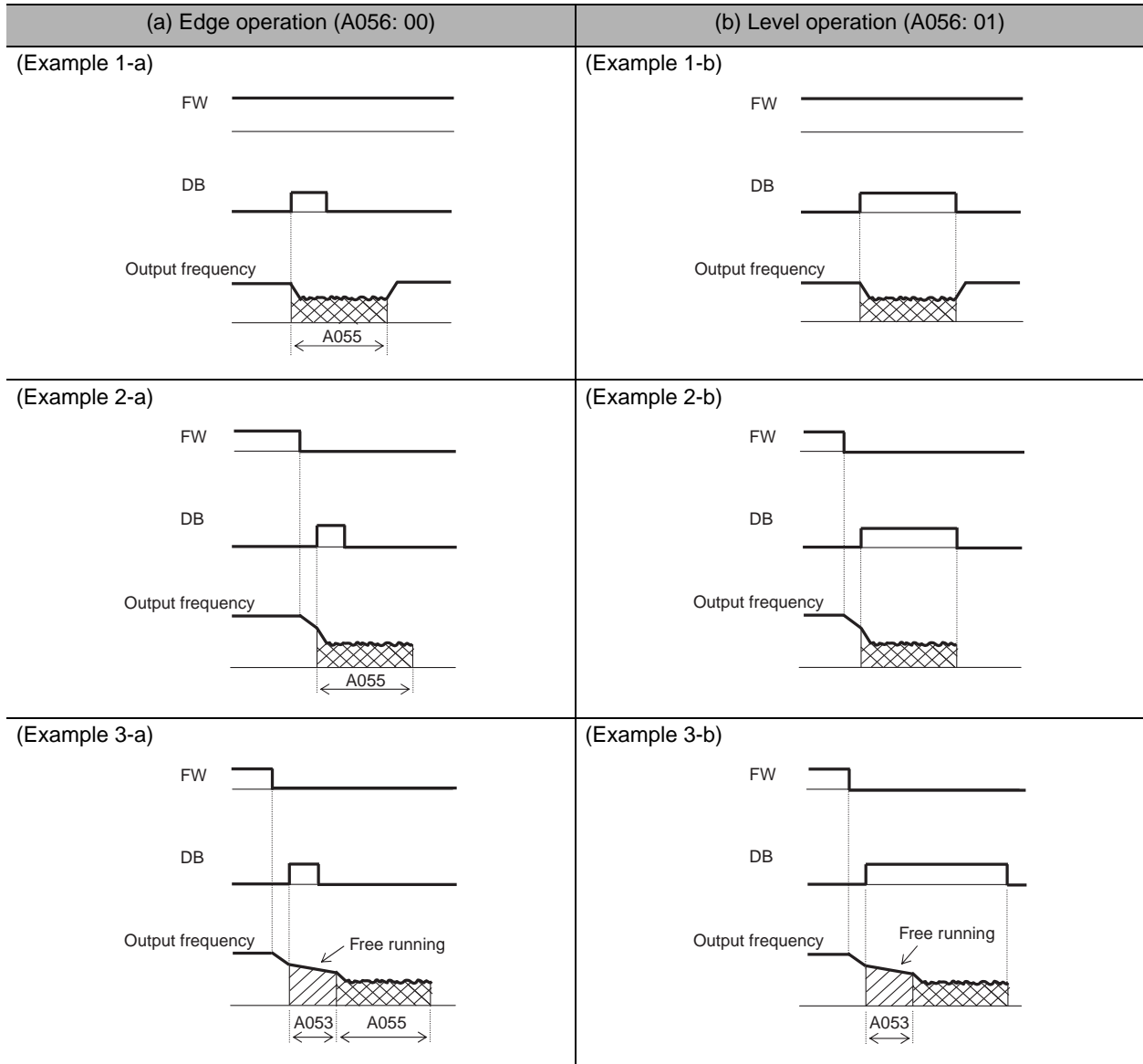

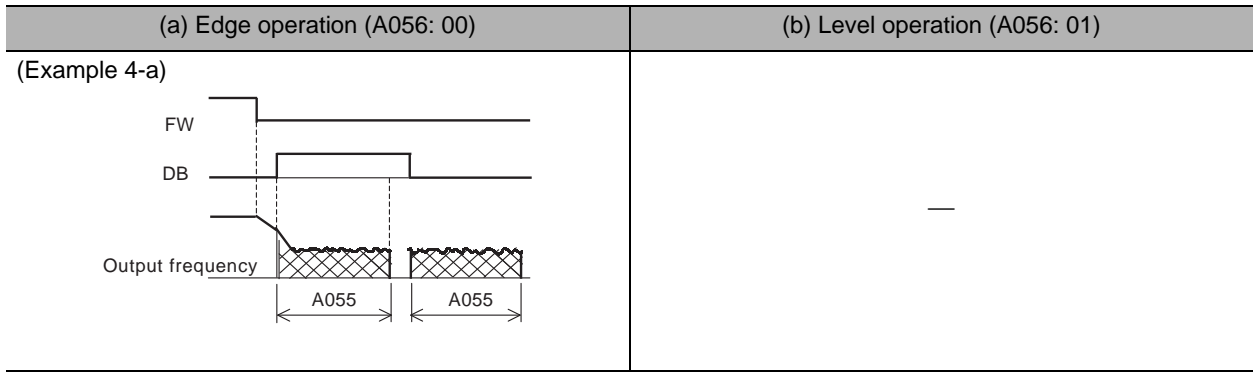

• **Internal DC Injection Braking (A051 = 01)**

- Performs DC injection braking to stop the motor without any terminal operation. To use this function, set the DC injection braking selection (A051) to 01.
- Adjust the DC injection braking power with A054.
- Set the frequency for starting DC injection braking in A052.
- If you set a DC injection braking frequency (A052) below the starting frequency (b082), internal DC injection braking operates at the starting frequency. Note that setting the DC injection braking frequency to 0.0 Hz disables internal DC injection braking.
- If the DC injection braking delay time (A053) is set, the output is shut off when the frequency reaches the level set in A052 during deceleration, and free-run status arises for the specified period. DC injection braking starts after the set time elapses.
- Below are edge/level operations in internal DC injection braking.

Edge operation: Giving priority to the DC injection braking time (A055), performs DC injection braking for the specified period.
 DC injection braking is activated for the set time in A055 when the output frequency reaches the set value in A052 after the RUN command (FW) is turned off.

Even if the RUN command is turned on during DC injection braking, the latter is effective during the set time in A055.

(Example 5-a), (Example 6-a)

Level operation: Giving priority to the RUN command, shifts to normal operation, ignoring the DC injection braking time (A055).

If the RUN command is turned on during DC injection braking, returns to normal operation, ignoring the set time in A055.

(Example 5-b), (Example 6-b)

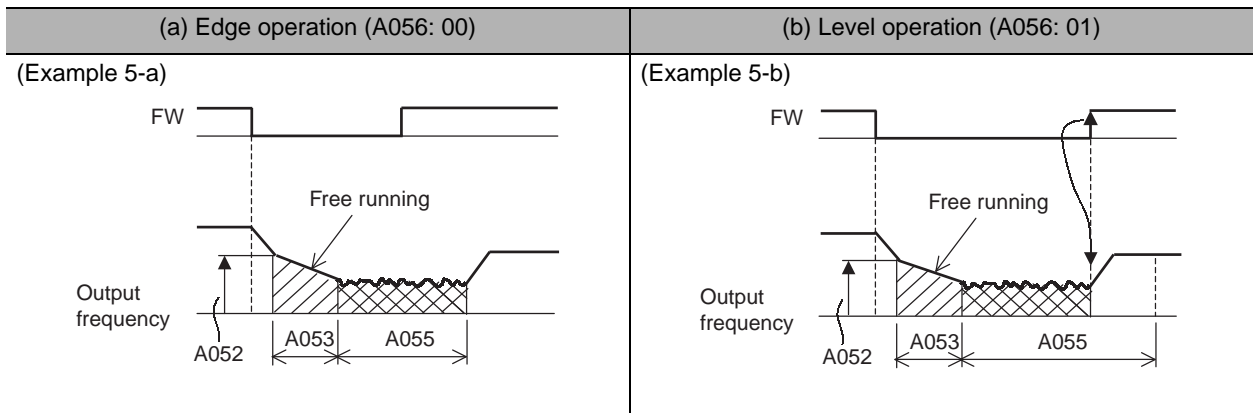

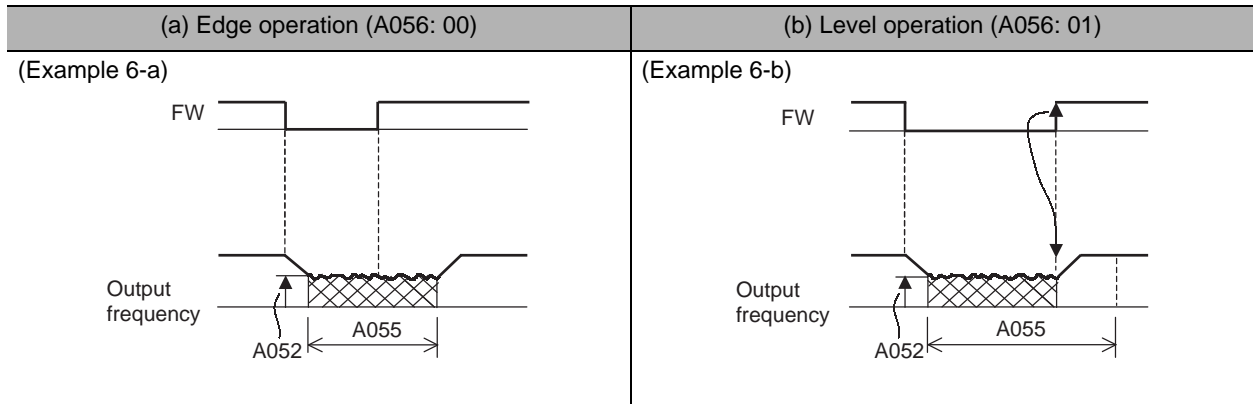

Frequency Limit

This function limits the Inverter output frequency.

Parameter No.	Function name	Data	Default setting	Unit
A061	Frequency upper limit	0.0/Frequency lower limit [A062] to Max. frequency [A004]	0.0	Hz
A261	* 2nd frequency upper limit	0.0/Frequency lower limit [A262] to Max. frequency [A204]	0.0	
A062	Frequency lower limit	0.0/Starting frequency to Frequency upper limit [A061]	0.0	
A262	* 2nd frequency lower limit	0.0/Starting frequency to Frequency upper limit [A261]	0.0	
Related functions		A004, A204, C001 to C006		

* To switch to the 2nd control, allocate 08 (SET) to the multi-function input and then turn it on.

- You can set both upper/lower limits to the set frequency. This function does not accept any frequency reference beyond the set limits.
- Set the upper limit first.
Make sure the upper limit (A061/A261) is higher than the lower limit (A062/A262).
Neither limit would work if set to 0 Hz.

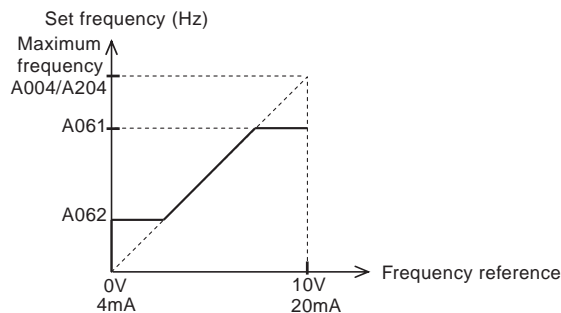

If the lower limit is set, the set value is prioritized even if 0 V (4 mA) is input for frequency reference.

Frequency Jump Function

This function helps avoid resonant points of loaded machines.

Parameter No.	Function name	Data	Default setting	Unit
A063 A065 A067	Jump frequency 1 Jump frequency 2 Jump frequency 3	0.0 to 400.0	0.0	Hz
A064 A066 A068	Jump frequency width 1 Jump frequency width 2 Jump frequency width 3	0.0 to 10.0	0.5	
Related functions		C001 to C006		

- The output frequency cannot be set within the frequency range set in the frequency jump function.
- The output frequency fluctuates continuously according to the acceleration/deceleration time during both actions. The jump frequency can be set at up to three points.

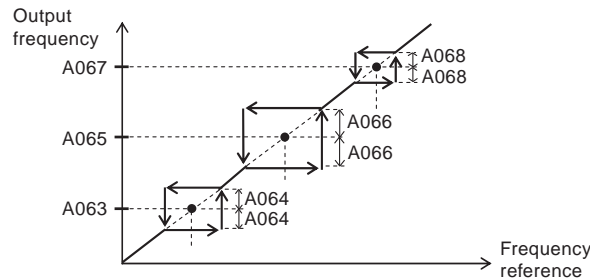

PID Function

This function enables process control of such elements as flow rate, air volume, and pressure.

Parameter No.	Function name	Data	Default setting	Unit
A071	PID selection	00: Disabled 01: Enabled	00	—
A072	PID P gain	0.2 to 5.0	1.0	—
A073	PID I gain	0.0 to 150.0	1.0	s
A074	PID D gain	0.00 to 100.0	0.0	s
A075	PID scale	0.01 to 99.99	1.00	Time
A076	PID feedback selection	00: FI 01: FV 02: RS485 communication 10: Operation function output	00	—
A077	Reverse PID function	00: Deviation = Target value - Feedback value 01: Deviation = Feedback value - Target value	00	—
A078	PID output limit function	0.00 to 100.0	0.0	%

Parameter No.	Function name	Data	Default setting	Unit
C044	PID deviation excessive level	0. to 100.	3.0	%
C052	PID FB upper limit	0.0 to 100.0	100.0	%
C053	PID FB lower limit		0.0	%
Related functions		d004, A001, A005, C001 to C006, C021 to C022, C026		

- To use this function, set A071 to 01.
- To switch between enable/disable through external signals, allocate 23 (PID enabled/disabled) to the desired multi-function input. Select OFF for "enabled" and ON for "disabled".

Feedback Selection

- Select a terminal for feedback signals in A076.
- The target value depends on the frequency reference selection A001 of the data not selected in A076.
The setting of FV/FI selection A005 is disabled when the control terminal block (terminal) 01 is set in A001.

Basic Structure of PID Control (Example)

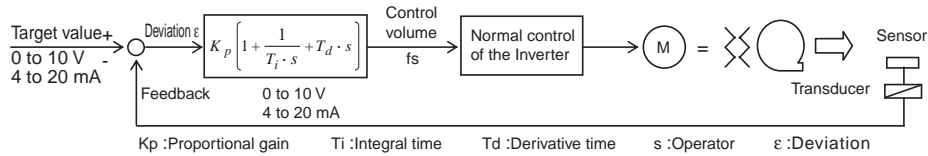

PID Operation

P Operation

- Operation where the control volume is proportional to the target value

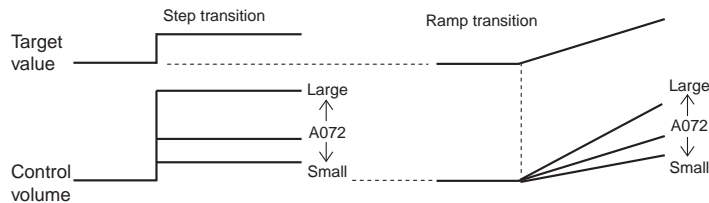

I Operation

- Operation where the control volume increases linearly according to time

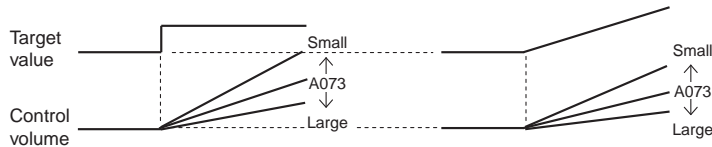

D Operation

- Operation where the control volume is proportional to the variation ratio of the target value

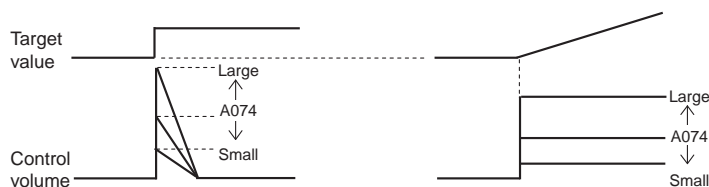

- PI operation is the combination of the above P and I operations; PD is P and D operations; PID is P, I and D operations.

■PID Gain Adjustment

- If a stable response cannot be obtained in PID function operation, adjust each gain as follows according to the situation.

- | | |
|---|-----------------|
| • Feedback value variation is slow when the target value is changed. | → Raise P gain. |
| • The feedback value changes fast but isn't stable. | → Lower P gain. |
| • The target and feedback values wouldn't match smoothly. | → Lower I gain. |
| • The feedback value fluctuates unstably. | → Raise I gain. |
| • Response is slow even with P gain raised. | → Raise D gain. |
| • With P gain raised, the feedback value fluctuates and isn't stable. | → Lower D gain. |

■Excessive Deviation/Output

- You can set PID deviation excessive level C044 during PID control. If the PID deviation reaches the PID deviation excessive level (C044), the multi-function output terminal is turned on.
- C044 can be set from 0 to 100. The setting corresponds to the range of 0 to the maximum target value.
- Allocate 04 (OD) to any of multi-function output terminals P1 and P2 (C021 and C022) or relay output terminals MA and MB (C026).

■PID Feedback Value Monitor

- You can monitor the PID feedback value with d004.
- The monitor value is displayed as the multiplied value of the PID scale (A075).
"Monitor display" = "Feedback value (%)" × "A075 setting"

■PID Integral Reset

- Clears the integral value of PID operation.
- Allocate 24 (PIDC) to the desired multi-function input.
- Clears the integral value every time the PIDC terminal is turned on.
Do not turn on the PIDC terminal during PID operation to avoid an overcurrent trip.
Turn on the PIDC terminal after turning off PID operation.
The integral value is cleared during free running or retry.

■PID Comparison Function

- This function outputs a signal when detecting that the PID feedback value exceeds the set range.
- Allocate 07 (FBV) to any of multi-function output terminals P1 and P2 (C021 and C022) or relay output terminals MA and MB (C026).
- Set the upper limit in C052, and the lower limit in C053. When the PID feedback value falls below the lower limit, the terminal is turned on. The ON status remains until the value exceeds the upper limit.
- The output signal is turned off while output is shut off (during stop or FRS, etc.).
- Helps control the number of fans and pumps.

AVR Function

- This function outputs voltage to the motor correctly even if the incoming voltage to the Inverter fluctuates. With this function, output voltage to the motor is based on that set in the motor voltage selection.

Parameter No.	Function name	Data	Default setting	Unit
A081	AVR selection	00: Always ON 01: Always OFF 02: OFF during deceleration	02	—
A082	AVR voltage selection	200-V class: 200/215/220/230/240 400-V class: 380/400/415/440/460/480	200/400	—
Related functions		d004, A001, A005		

- With A081 (AVR selection), set whether to enable or disable this function.
- Note that the Inverter cannot output voltage beyond that of the incoming voltage.
- To avoid a possible overcurrent trip during deceleration, set the AVR selection to "Always ON" (A081: 00).

Parameter No.	Data	Description	Note
A081	00	Always ON	Enabled during acceleration, constant speed, and deceleration.
	01	Always OFF	Disabled during acceleration, constant speed, and deceleration.
	02	OFF during deceleration	Disabled only during deceleration in order to reduce the energy regenerated to the Inverter by increasing the motor loss. This will avoid a possible trip due to regeneration during deceleration.

2-step Acceleration/Deceleration Function (2CH)

By setting this function, you can change the acceleration/deceleration time during acceleration/deceleration.

Parameter No.	Function name	Data	Default setting	Unit
A092	Acceleration time 2	0.01 to 99.99 100.0 to 999.9	15.0	s
A292	* 2nd acceleration time 2	1000. to 3000.	15.0	s
A093	Deceleration time 2	0.01 to 99.99 100.0 to 999.9	15.0	s
A293	* 2nd deceleration time 2	1000. to 3000.	15.0	s
A094	2-step acceleration/ deceleration selection	00: Switched via multi-function input 09 (2CH) 01: Switched by setting	00	—
A294	* 2nd 2-step acceleration/ deceleration selection	00: Switched via multi-function input 09 (2CH) 01: Switched by setting	00	—
A095	2-step acceleration frequency	0.0 to 400	0.0	Hz
A295	* 2nd 2-step acceleration frequency	0.0 to 400	0.0	Hz
A096	2-step deceleration frequency	0.0 to 400	0.0	Hz
A296	* 2nd 2-step deceleration frequency	0.0 to 400	0.0	Hz
Related functions		F002, F003, F202, F203, C001 to C006		

* To switch to the 2nd control, allocate 08 (SET) to the multi-function input and then turn it on.

- The acceleration/deceleration time can be switched via the multi-function input or automatically with an arbitrary frequency.
- To switch via a multi-function input, allocate 09 (2CH) to it.

(Example 1) When A094/A294 is set to 00

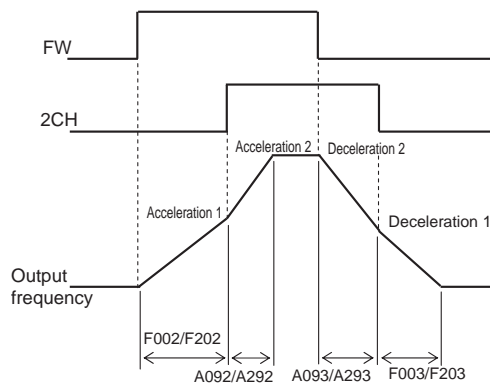

(Example 2) When A094/A294 is set to 01

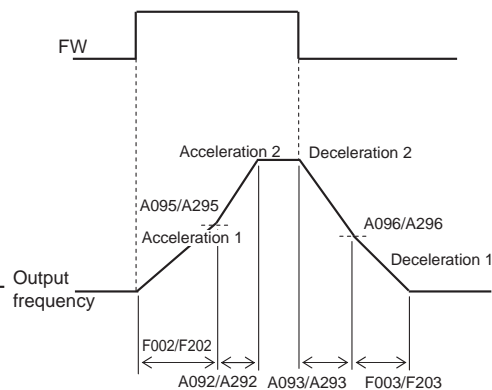

Acceleration/Deceleration Pattern

This function is used when smooth acceleration/deceleration is needed.

Parameter No.	Function name	Data	Default setting	Unit
A097	Acceleration pattern selection	00: Line 01: S-shape curve	00	—
A098	Deceleration pattern selection	00: Line 01: S-shape curve	00	—

•Acceleration/deceleration pattern can be set according to each system.

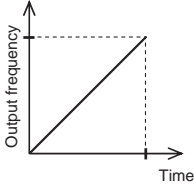
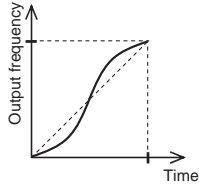
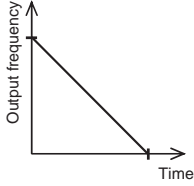
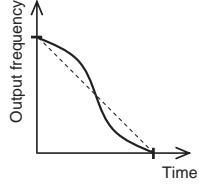
Parameter No.	Set value	
A097 (Acceleration)		
A098 (Deceleration)		
Description	Accelerates/Decelerates linearly before reaching the set output frequency value.	Helps prevent the collapse of cargo on the elevating machine or conveyor.

Operation Frequency Function

This function makes calculations for two inputs and reflects the result as the output frequency.

Parameter No.	Function name	Data	Default setting	Unit
A141	Operation frequency Input A setting	00: Digital Operator (F001) 01: Digital Operator (FREQ adjuster)	02	—
A142	Operation frequency Input B setting	02: Input FV 03: Input FI 04: RS485 communication		
A143	Operator selection	00: Addition (A + B) 01: Subtraction (A - B) 02: Multiplication (A × B)	00	—
Related functions		A001=10		

•Inputs FV and FI cannot be set simultaneously. Do not connect the signal lines for inputs FV and FI simultaneously.

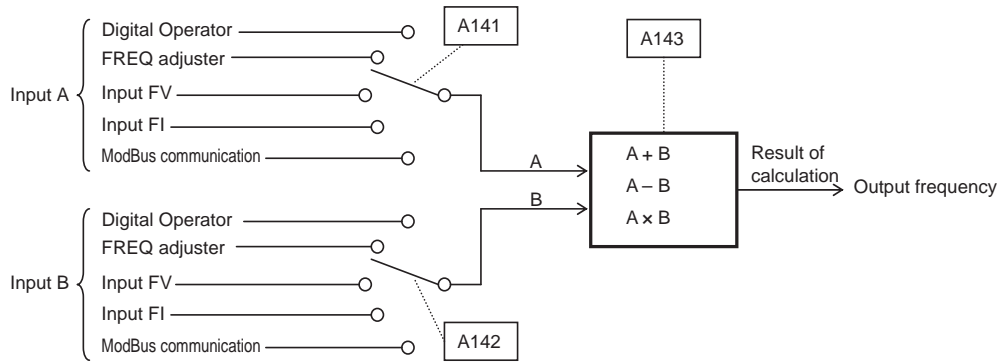

Frequency Addition Function

This function adds or subtracts the constant frequency set in A145 to/from the output frequency. Select addition or subtraction in A146.

Parameter No.	Function name	Data	Default setting	Unit
A145	Frequency addition amount	0.0 to 400.0	0.0	Hz
A146	Frequency addition direction	00: Adds the A145 value to the output frequency 01: Subtracts the A145 value from the output frequency	00	—
Related functions		C001 to C006, ADD input		

- Inputs FV and FI cannot be set simultaneously. Do not connect the signal lines for inputs FV and FI simultaneously.

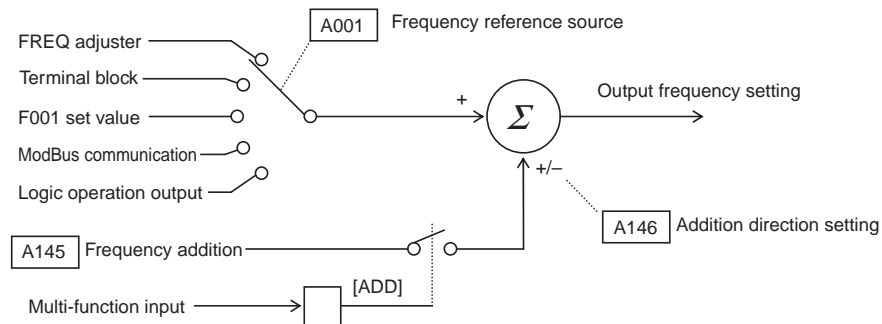

<Group B: Detailed Function Parameters>**Momentary Power Interruption/Trip Retry (Restart)**

This function allows you to determine the operation performed when a trip occurs due to momentary power interruption, undervoltage, overcurrent, or overvoltage.
Set the retry condition according to your system.

Parameter No.	Function name	Data	Default setting	Unit
b001	Retry selection	00: Outputs an alarm after a trip. 01: Restarts from 0 Hz at retry. 02: Matches the frequency at retry and starts. 03: Performs frequency pull-in start at retry and trips after deceleration stop.	00	—
b002	Allowable momentary power interruption time	0.3 to 25.0 Restarts if the momentary power interruption is within the set time. If not, it trips.	1.0	s
b003	Retry wait time	0.3 to 100.0 Time from recovery to restart	1.0	s
b004	Momentary power interruption/undervoltage trip during stop selection	00: Disabled 01: Enabled	00	—
b005	Momentary power interruption retry time selection	00: 16 times 01: No limit	00	—
Related functions		C021 to C022, C026		

■ Trip Retry Function

- Select the retry function during operation in [b001] (01 or 02). If [b005] is 00 (default), the following operations are to be performed.

At the time of momentary power interruption and undervoltage: Restarts 16 times and trips on the 17th time.

At the time of overcurrent and overvoltage: Restarts 3 times respectively and trips on the 4th time.

Retry times are counted separately for momentary power interruption, undervoltage, overcurrent, and overvoltage. For example, an overvoltage trip occurs only after 3-time overcurrent trips and then 4-time overvoltage trips. For momentary power interruption and undervoltage, if [b005] is set to 01, the retry operation continues until the status is cleared.

- You can select the operation for momentary power interruption and undervoltage during stop in b004.

(Supplemental Information)

Frequency matching start: Restarts the motor without stopping it after matching the motor rotation speed. (If the RUN command is set on the Digital Operator (A002 = 2), the Inverter stops.)

- Below is the timing chart where the retry function (b001: 02) is selected. However, if power is completely discharged, conditions will change regardless of settings to what they are when the power supply is initially turned on.

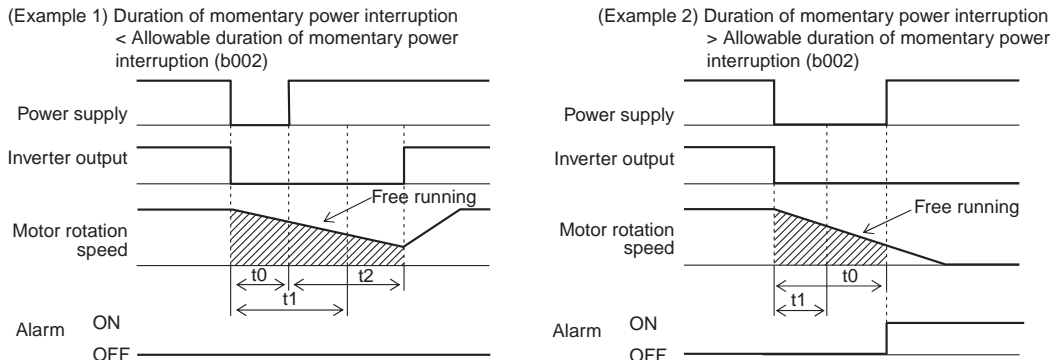

[t0: Duration of momentary power interruption / t1: Allowable duration of momentary power interruption (b002) / t2: Retry wait time (b003)]

Alarm Selection for Momentary Power Interruption/Undervoltage During Stop

- Use b004 to select whether to enable an alarm output in case of momentary power interruption or undervoltage.
- An alarm output continues while Inverter control power supply remains.

Alarm output for momentary power interruption and undervoltage during stop (Examples 3 and 4)

(Example 3) b004: 00

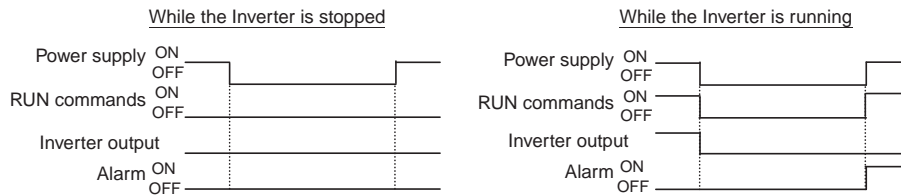

(Example 4) b004: 01

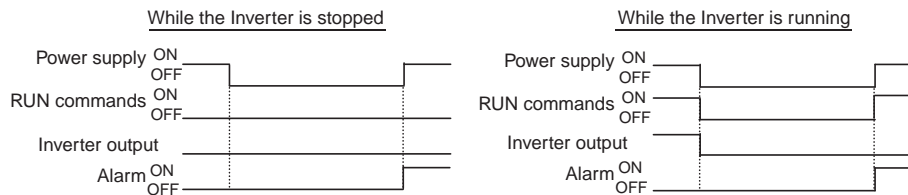

Electronic Thermal Function

- This function electronically protects the motor from overheating.

Parameter No.	Function name	Data	Default setting	Unit
b012	Electronic thermal level	0.2 × Rated current to 1.2 × Rated current	Rated current	A
b212	* 2nd electronic thermal level		Rated current	A
b013	Electronic thermal characteristics selection	00: Reduced torque characteristics 1 01: Constant torque characteristics 02: Reduced torque characteristics 2	00	—
b213	* 2nd electronic thermal characteristics selection			
Related functions		C021 to C022, C026		

* To switch to the 2nd control, allocate 08 (SET) to the multi-function input and then turn it on.

- Causes an overload trip (E06) to protect the motor from overheating by setting according to the motor rated current.
- Provides the most appropriate protection characteristics, taking into account the decline of the motor cooling capability at a low speed.
- To set a value over the rated current of the motor, be careful of any temperature rise of the motor.

■ Electronic Thermal Level (Motor Protection Level)

(Example) 3G3MX-A2007

Rated current: 5.0 A

Setting range: 1.0 to 6.0 A

- The following figure shows the time limit characteristics with the electronic thermal level (b012) set to 5.0 A.

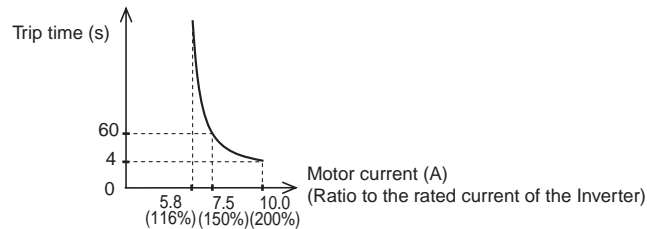

■ Electronic Thermal Characteristics

- Frequency characteristics are multiplied by the b012/212 set value shown above.
- The lower the output frequency is, the lower the cooling capability of the standard motor's self-cooling fan.

Reduced Torque Characteristics 1

- Multiplied by the time limit characteristics set in b012/212 for each frequency.

(Example) 3G3MX-A2007 (Rated current: 5.0 A), b012 = 5.00 (A),
Output frequency = 20 Hz

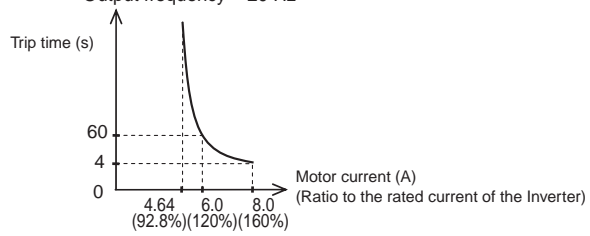
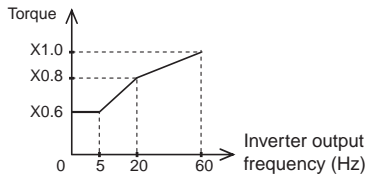

Constant Torque Characteristics

- Do not skip this setting when using a constant torque motor.
- Multiplied by the time limit characteristics set in b012/212 for each frequency.

(Example) 3G3MX-A2007 (Rated current: 5.0 A), b012 = 5.00 (A),
Output frequency = 2.5 Hz

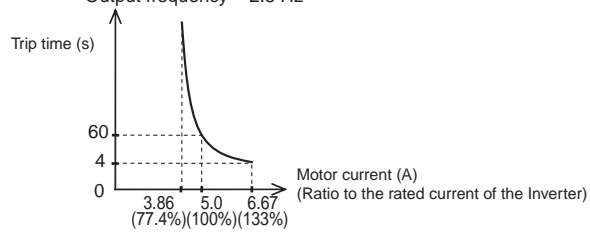
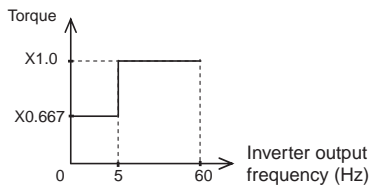

Reduced Torque Characteristics 2

- Multiplied by the time limit characteristics set in b012/212 for each frequency.

(Example) 3G3MX-A2007 (Rated current: 5.0 A), b012 = 5.00 (A),
Output frequency = 40 Hz

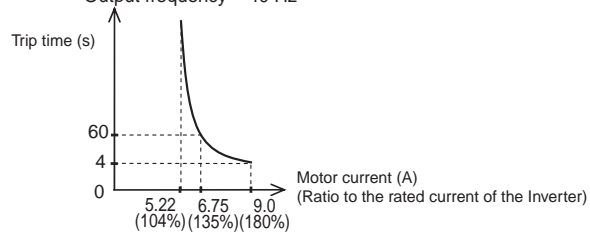
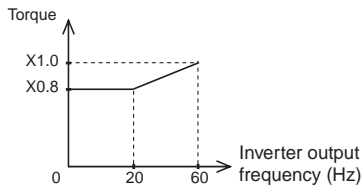

Overload Limit/Overload Warning

This function helps prevent an overcurrent trip due to rapid load fluctuation in acceleration or constant speed operation.

Parameter No.	Function name	Data	Default setting	Unit
b021	Overload limit selection	00: Disabled 01: Enabled in acceleration/constant speed operation 02: Enabled in constant speed operation	01	—
b221	*2nd overload limit selection		01	—
b022	Overload limit level	0.1 × Rated current to 1.5 × Rated current	1.5 × Rated current	A
b222	*2nd overload limit level		1.5 × Rated current	A
b023	Overload limit parameter	0.1 to 3000.0 (Deceleration time while this function is in operation)	1.0	s
b223	*2nd overload limit parameter		1.0	s
b028	Overload limit source selection	00: b022, b222 set values 01: Input terminal FV	00	—
b228	*2nd overload limit source selection		00	—
C041	Overload warning level	0.0: Does not operate. 0.1 × Rated current to 2.0 × Rated current (Outputs OL signal when reaching the overload warning level.)	Rated current	A
C241	*2nd overload warning level		Rated current	
Related functions		C021 to C022, C026		

* To switch to the 2nd control, allocate 08 (SET) to the multi-function input and then turn it on.

■ Overload Limit

- The Inverter monitors the motor current during acceleration or constant speed operation. If it reaches the overload limit level, the output frequency is lowered automatically according to the overload limit parameter.
- This function prevents an overcurrent trip caused by inertia moment during acceleration, or caused by rapid load fluctuations during constant speed operation.
- The overload limit level sets a current value for this function to work.
- When this function operates, the acceleration time becomes longer than the set time.
- With the overload limit parameter set too low, an overvoltage trip may occur due to regenerative energy from the motor. This is because of automatic deceleration from this function even during acceleration.
- Make the following adjustments if this function operates during acceleration and the frequency doesn't reach the target level.
 - Increase the acceleration time.
 - Increase the torque boost.
 - Increase the overload limit level.
 - Use a higher rank Inverter.

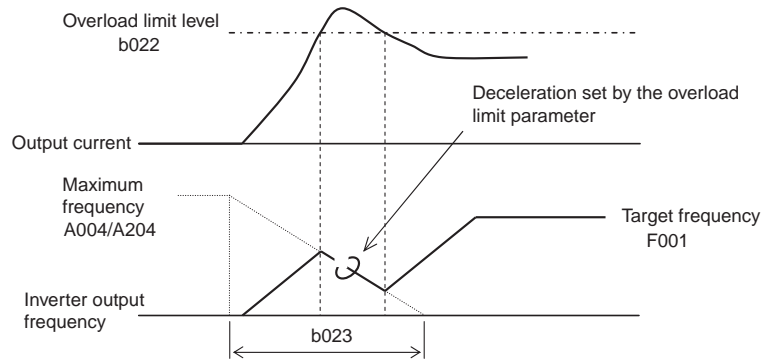

Overload Warning

- If the load is too large, this function outputs an overload warning signal, allowing you to readjust the overload level to prevent a trip. This helps prevent mechanical damage due to an overload in the conveyors, or an operation line stop due to an overload trip of the Inverter.
- Allocate 03 (OL) to the multi-function output (terminal P1, P2) or relay output.

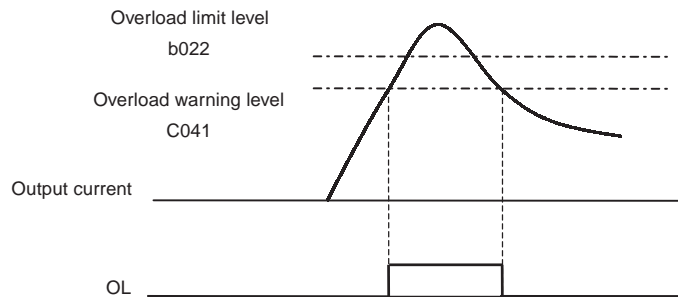

Soft Lock Function

Use this function to prohibit writing of each parameter. This helps prevent data rewrite due to erroneous operation.

For the soft lock selection through the signal input from the terminal (b031 = 00 or 01), refer to the Soft Lock Function of the Multi-function Input section in "Soft Lock Function" (page 4-47).

Parameter No.	Function name	Data	Default setting	Unit
b031	Soft lock selection	00: Data other than b031 cannot be changed when the SFT terminal is ON. 01: Data other than b031 and specified frequency parameters cannot be changed when the SFT terminal is ON. 02: Data other than b031 cannot be changed. 03: Data other than b031 and the specified frequency parameter cannot be changed. 10: Data other than parameters changeable during operation cannot be changed.	01	—
Related functions		SFT input		

- This helps prevent data rewriting due to erroneous operation.
- Select the soft lock setting and performing method from the above table.
- When using the multi-function input, allocate 15 (SFT) to it.

AM Adjustment

You can adjust the analog voltage (0 to 10 V DC) from the AM terminal on the control terminal block.

Parameter No.	Function name	Data	Default setting	Unit
b080	AM adjustment	0. to 255.	Default adjustment value	—
C028	AM selection	00: Output frequency 01: Output current	00	—
C086	AM offset adjustment	0.0 to 10.0	0.0	V

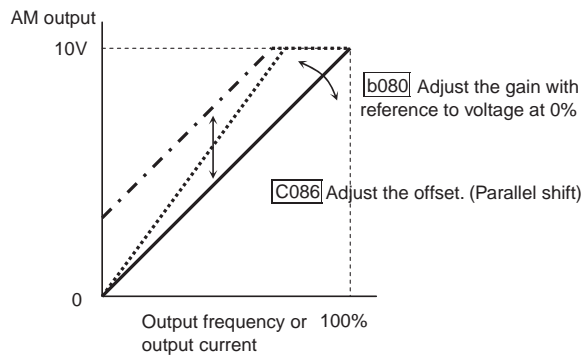

Note: If the offset (C086) is changed, the point to reach 10 V changes accordingly because of parallel movement. To avoid this, adjust the offset (C086) before the gain (b080).

Starting Frequency

- Set the frequency for starting Inverter output when the RUN signal is turned on.

Parameter No.	Function name	Data	Default setting	Unit
b082	Starting frequency	0.5 to 9.9	0.5	Hz

- Use mainly to adjust the starting torque.
- With the starting frequency set high, the starting current increases. Therefore, the current may exceed the overload limit and cause an overcurrent trip.

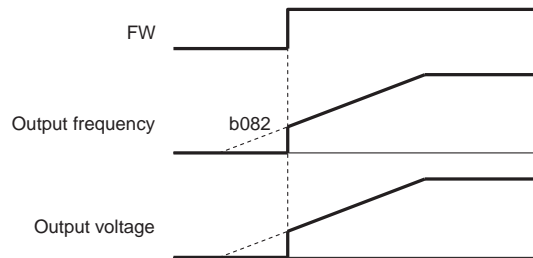

Carrier Frequency

You can change the PWM waveform carrier frequency output from the Inverter with b083.

Parameter No.	Function name	Data	Default setting	Unit
b083	Carrier frequency	2.0 to 14.0	5.0	kHz

- With the carrier frequency set high, you can reduce metallic noise form the motor. However, this may increase noise or leakage current from the Inverter.
- Helps avoid mechanical or motor resonance.
- To raise the carrier frequency, derate the output current as shown in the graph below. (when the ambient temperature is 40°C)

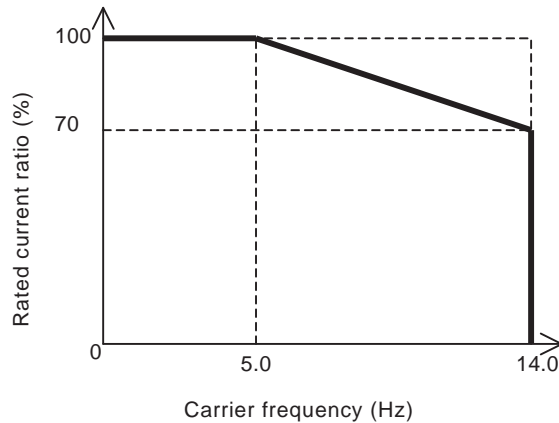

Parameter Initialization

You can initialize the rewritten set values and reset to the factory default, or clear trip records. Note that this is not available for RUN and power ON times.

Parameter No.	Function name	Data	Default setting	Unit
b084	Initialization selection	00: Clears the trip monitor 01: Initializes data 02: Clears the trip monitor and initializes data	00	—
b085	Initialization parameter selection	00: Do not change.	00	—

■ Initialization Method

After setting the parameter, use the following method to initialize.

- (1) Press the STOP/RESET key with the Mode and Increment/Decrement keys pressed simultaneously.
Release the STOP/RESET key when the display blinks.
Release the Mode and Increment/Decrement keys.

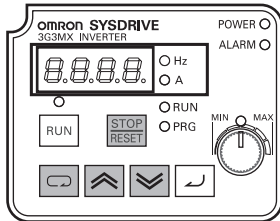

- (2) Initializing

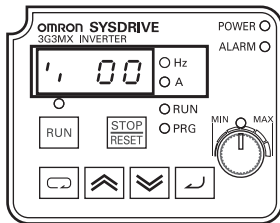

- (3) Initialization completes with "d001" displayed on the monitor.

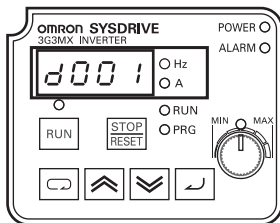

The multi-function inputs/outputs are also initialized with this function. To avoid unexpected operation, be sure to re-examine the wiring.

Stabilization Parameter

- This function adjusts to reduce motor hunting.
- In case of motor hunting, check whether the motor capacity selection (H003/H203) and motor pole number selection (H004/H204) match your motor. If they do not, match them.
- For adjustment, raise the stabilization parameter (H006) by degrees. If this increases motor hunting, lower it by degrees.
- Other than this function, the following methods are suggested to reduce hunting:
 - Lower the carrier frequency (b083)
 - Lower the output voltage gain (A045)

Parameter No.	Function name	Data	Description
A045	Output voltage gain	20. to 100.	Unit: % If hunting occurs, reduce the set value.
b083	Carrier frequency	2.0 to 14.0	Unit: kHz If hunting occurs, reduce the set value.
H006/H206	Stabilization parameter	0. to 255.	If hunting occurs, adjust the set value.

FV/FI Adjustment

You can adjust the FV/FI frequency input.
Use this to change the full scale of input.
The set frequency becomes 0 Hz with 0.0% set.
This returns to the factory default value after initialization.

Function code	Item	Data	Description
C081	FV adjustment	0.0 to 200.0%	Unit: %
C082	FI adjustment	0.0 to 200.0%	Unit: %
Related functions		A011, A101, A012, A102, A013, A103, A014, A104, A015, A105	

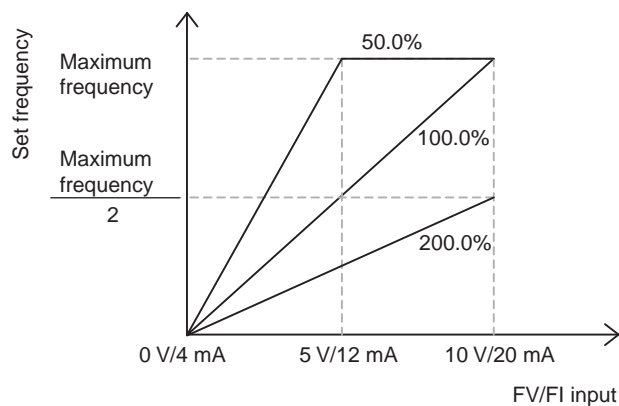

Frequency Conversion Coefficient

This function displays a conversion value obtained by multiplying the Inverter output frequency by the coefficient set in [b086]. This helps display the actual physical value on the monitor.

Function code	Item	Data	Default setting	Unit
b086	Frequency conversion coefficient	0.1 to 99.9	1.0	—
Related functions		d007		

Displayed value [d007] = "Output frequency [d001]" × "Frequency conversion coefficient [b086]"

(Display) [d007]

- 0.00 to 99.99 : Displays in increments of 0.01.
- 100.0 to 999.9 : Displays in increments of 0.1.
- 1000. to 9999. : Displays in increments of 1.
- 1000 to 3996 : Displays in increments of 10.

(Setting range) [b086]

- 0.1 to 99.9: 0. : Can be set in increments of 1.

(Example) When the output frequency [d001] = 50.0 Hz, and the frequency conversion coefficient [b086] = 1.1, the monitor [d007] displays "55.0" through $50.0 \times 1.1 = 55.0$.

STOP Key Selection

- You can select whether to enable the STOP key on the Digital Operator, even if the RUN command is set to the control terminal block (terminal).
- The trip reset function via the STOP/RESET key works according to this setting.

Parameter No.	Function name	Data	Default setting	Unit
b087	STOP key selection	00: Enabled 01: Disabled	00	—

Free-run Stop Selection and Stop Selection

Activating the free-run stop (FRS) function shuts off the Inverter output, letting the motor go into free-run status.

Parameter No.	Function name	Data	Default setting	Unit
b088	Free-run stop selection	00: 0 Hz start 01: Frequency pull-in restart	00	—
b091	Stop selection	00: Deceleration → Stop 01: Free-run stop	00	—
b003	Retry wait time	0.3 to 100.0	1.0	s
Related functions		C001 to C006		

- Helps stop the motor using a mechanical brake such as an electromagnetic one.

- Note that an overcurrent trip may occur if the mechanical brake forces the motor to stop during Inverter output.
- Allocate 11 (FRS) to the desired multi-function input.
- Performs a free-run stop (FRS) while the FRS terminal is turned on.
When the FRS terminal is turned off, the motor restarts after retry wait time b003 elapses.
With RUN command selection A002 set to 01 (control terminal), the motor restarts only if the FW terminal is turned on, even in free running.
- You can select the Inverter output mode for restart at free-run stop selection b088 (0 Hz start or frequency matching restart). (Examples 1, 2)
- The setting of this function is also applied to stop selection b091.

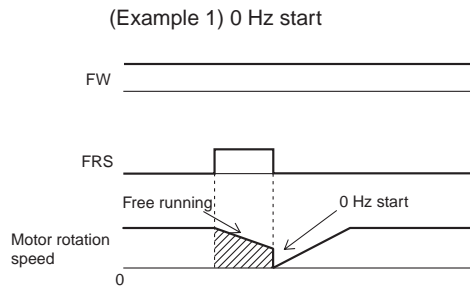

- The Inverter starts running at 0 Hz regardless of the motor rotation speed.
- The retry wait time is ignored at 0 Hz start.
- If the Inverter starts running at 0 Hz with the motor rotation speed high, an overcurrent trip may occur.

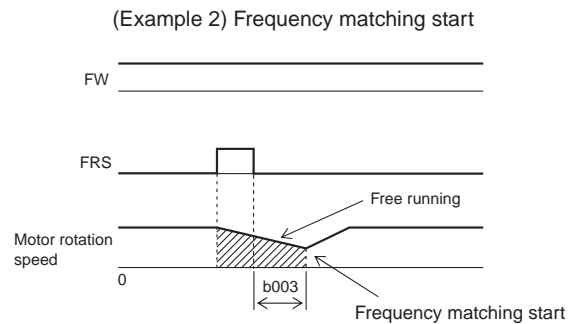

- After the FRS terminal is turned off, the motor frequency is matched and a frequency matching starts without stopping the motor. If this causes an overcurrent trip, extend the retry wait time.

Cooling Fan Control

- You can set whether to operate the Inverter's cooling fan constantly or only during Inverter operation.

This function applies to the Inverter models with a built-in cooling fan.

Parameter No.	Function name	Data	Default setting	Unit
b092	Cooling fan control	00: Always ON 01: ON during RUN 02: Depends on the fin temperature	01	—
Data	Description			
00	Operates constantly.			
01	Operates only during RUN. The cooling fan operates for 5 minutes after power-on, and for 5 minutes after the Inverter stops.			
02	Operates when the fin temperature is 50°C or higher.			

Regenerative Braking Function

- With the built-in regenerative braking circuit, this function allows an external braking resistor to consume the motor's regeneration energy as heat.
This function is useful for a system in which the motor works as a generator when it is rapidly decelerated.
- To use this function, configure the following settings.

Parameter No.	Function name	Data	Default setting	Unit
b090	Usage rate of regenerative braking function	00: Does not operate. 01 to 100.0: A BRD usage rate for 100 seconds can be set, in increments of 0.1%. If the set usage rate is exceeded, a braking resistor overload trip (E06) occurs.	0.0	%
		<p style="text-align: center;"> $\text{Usage rate (\%)} = \frac{(t1 + t2 + t3)}{100 \text{ s}} \times 100$ </p>		
b095	Regenerative braking function operation selection	00: Disabled (This function is not active.) 01: Enabled during operation (This function is active.) Disabled during stop (This function is not active.) 02: Enabled during both operation and stop (This function is active.)	0.0	—
b096	Regenerative braking function ON level	200-V class: 330 to 380 * 400-V class: 660 to 760 * (Inverter DC voltage)	200-V class: 360 V 400-V class: 720 V	V

* The regenerative braking function ON level conforms to the voltage setting for the Inverter's internal converter (DC unit).

- When using the regenerative braking function, mount the optional braking resistor between terminals P/+2 and RB, in addition to the settings above.

Model	200-V class				400-V class		
Minimum resistance (recommended)	100 Ω	50 Ω	35 Ω	17 Ω	180 Ω	100 Ω	70 Ω
Usage rate of regenerative braking function *	10%						

* The above usage rate of the regenerative braking function is the figure for using the optional braking resistor (3G3AX-RBA, RBB, RBC).

- When using an external regenerative braking unit, set the usage rate of the regenerative braking function to 0.0% (b090: 0.0) or disable the regenerative braking function selection (b095: 00). Do not mount the braking resistor between terminals P/+2 and RB.

Overvoltage LAD Stop Function

- This function helps avoid an overvoltage trip of the Inverter due to regenerative energy from the motor during deceleration.

Parameter No.	Function name	Data	Default setting	Unit
b130	Overvoltage LAD stop function	00: Disabled 01: Enabled	00	—
b131	Overvoltage LAD stop function level setting	200-V class: 330 to 395 400-V class: 660 to 790 (Inverter DC voltage)	200-V class: 380 V 400-V class: 760 V	V

- Select to enable or disable the overvoltage LAD stop function in b130.
- Adjust the overvoltage LAD stop function level in b131.
- The main circuit DC voltage rises because of regenerative energy from the motor once deceleration starts. With the overvoltage LAD stop function enabled (b130 = 1), the Inverter stops deceleration temporarily once the main circuit DC voltage has reached the overvoltage LAD stop level, which is lower than the overvoltage level. Deceleration then resumes if the voltage level falls below the overvoltage LAD stop level.
- With the overvoltage LAD stop function enabled (b130: 01), the actual deceleration time becomes longer than the set value (F003/F203).
- This function does not aim to keep the main circuit DC voltage level constant. Therefore, an overvoltage trip may occur if the main circuit DC voltage rises rapidly because of rapid deceleration.

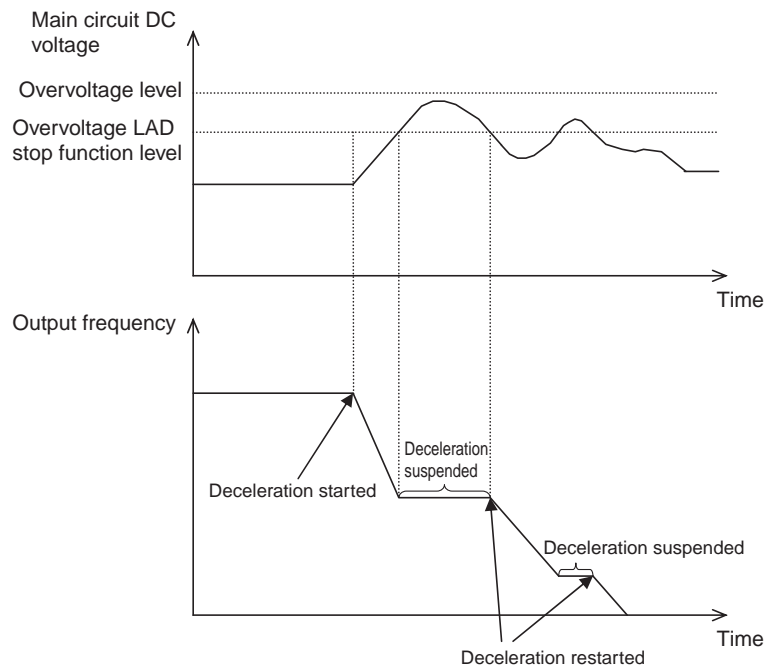

Overcurrent Suppression Function

- This function suppresses overcurrent caused by a steep current rise in rapid acceleration.
- Select to enable or disable the overcurrent suppression function in b140.
- This function does not operate during deceleration.

Parameter No.	Function name	Data	Default setting	Unit
b140	Overcurrent suppression function	00: Disabled 01: Enabled	00	—

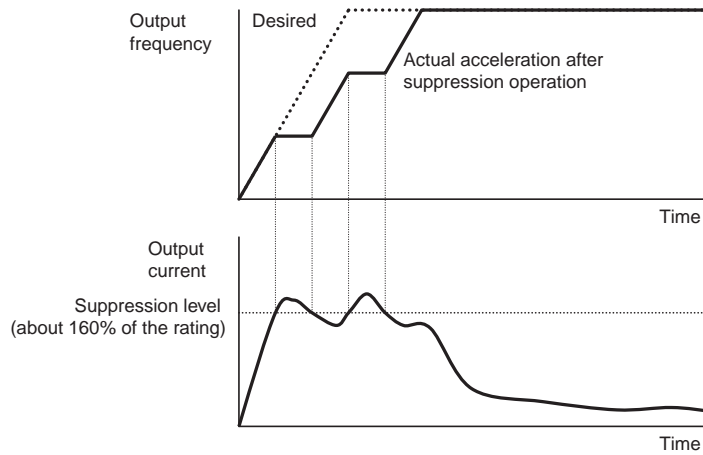

Automatic Carrier Frequency Reduction Function

This function automatically lowers the set carrier frequency when the temperature of the semiconductor inside the Inverter becomes high.

Parameter No.	Function name	Data	Default setting	Unit
b150	Automatic carrier reduction	00: Disabled 01: Enabled	00	—

- While this function is activated, the noise from the motor may be heard differently because of automatic change in carrier frequency.

RDY (Ready) Function

This function prepares for Inverter output to rotate the motor immediately after a RUN command is input.

Parameter No.	Function name	Data	Default setting	Unit
b151	Ready function selection	00: Disabled 01: Enabled	00	—

- When this function is enabled, the RUN (during RUN) LED indicator is always lit, since the Inverter is in output status even though the motor stops.
- Allocate '52 (operation ready)' to any of multi-function inputs C001 to C006, or set b151 to '01'. Refer to the table below for the correlation when the multi-function input '52' and b151 are set simultaneously.
- When this function is enabled, data other than the parameters changeable during operation cannot be changed.

		Multi-function input terminal "52"	
		OFF	ON
b151 setting	00	OFF	ON
	01	ON	ON

<Group C: Multi-function Terminal Function>

The 3G3MX has six multi-function inputs [S1], [S2], [S3], [S4], [S5] and [S6]; two open collector output terminals [P1], [P2]; two relay output terminals [MA] and [MB] (SPDT contact); and one analog output terminal [AM].

Multi-function Input Selection

- You can allocate the following functions to any of multi-function inputs S1 to S6 (C001 to C006, C201 to C206) to operate the set function.
- You can select NO- or NC-contact input for each multi-function input S1 to S6.

4-2 Function Mode

- The same two functions cannot be allocated to the multi-function inputs. If you attempt to allocate the same two functions to the terminals by mistake, the terminal where you allocated the function last takes precedence. The previous data is set to "255", and the terminal function is disabled.

Parameter No.	Function name	Data	Default setting	Unit
C001	Multi-function input 1 selection	00: FW(forward) 01: RV(reverse)	00	—
C201	*2nd multi-function input 1 selection	02: CF1 (multi-step speed binary 1) 03: CF2 (multi-step speed binary 2) 04: CF3 (multi-step speed binary 3)		
C002	Multi-function input 2 selection	05: CF4 (multi-step speed binary 4) 06: JG (jogging)	01	—
C202	*2nd multi-function input 2 selection	07: DB (external DC injection braking) 08: SET (2nd control) 09: 2CH (2-step acceleration/deceleration)		
C003	Multi-function input 3 selection	11: FRS (free run) 12: EXT (external trip) 13: USP (USP function)	18	—
C203	*2nd multi-function input 3 selection	15: SFT (soft lock) 16: AT (analog input switching)		
C004	Multi-function input 4 selection	18: RS (reset) 19: PTC (thermistor input)	12	—
C204	*2nd multi-function input 4 selection	20: STA (3-wire start) 21: STP (3-wire stop) 22: F/R (3-wire forward/reverse)		
C005	Multi-function input 5 selection	23: PID (PID enabled/disabled) 24: PIDC (PID integral reset)	02	—
C205	*2nd multi-function input 5 selection	27: UP (UP/DWN function accelerated) 28: DWN (UP/DWN function decelerated) 29: UDC (UP/DWN function data clear)		
C006	Multi-function input 6 selection	31: OPE (forced operator) 50: ADD (frequency addition) 51: F-TM (forced terminal block)	03	—
C206	*2nd multi-function input 6 selection	52: RDY (ready function) 53: SP-SET (special 2nd function) 255: No function		
C011	Multi-function input 1 operation selection	00: NO 01: NC • NO contact: "ON" with the contact closed, "OFF" with the contact open. • NC contact: "ON" with the contact open. "OFF" with the contact closed. • For the RS terminal, only NO contact is available.	00	—
C012	Multi-function input 2 operation selection		00	—
C013	Multi-function input 3 operation selection		00	—
C014	Multi-function input 4 operation selection		00	—
C015	Multi-function input 5 operation selection		00	—
C016	Multi-function input 6 operation selection		00	—

* To switch to the 2nd control, allocate 08 (SET) to the multi-function input and then turn it on.

- Function codes C001/C201 to C006/C206 correspond to multi-function inputs S1 to S6 respectively.
- '19: Thermistor input' can be allocated only to multi-function input S6.

- In the following multi-function input settings, if you allocate a function to one code (C001 to C006), the same function will be allocated to the other code (C201 to C206) automatically.
08: 2nd control, 11: Free run, 12: External trip, 18: Reset, 19: Thermistor input, 23: PID enabled/disabled, 53: Special 2nd function
- "08: 2nd control" and "53: Special 2nd function" cannot be allocated simultaneously. If you attempt to do so, the terminal where you last allocated the function takes precedence. The previous data is set to "255: No allocation", and the terminal function is disabled.

Multi-step Speed Operation Function

- You can set RUN speeds using codes and switch between the set speeds via the terminal.

Parameter No.	Function name	Data	Default setting	Unit
A020/A220	Multi-step speed reference 0/ * 2nd multi-step speed reference 0	0.0/Starting frequency to Max. frequency	6.0	Hz
A021	Multi-step speed reference 1	0.0/Starting frequency to Max. frequency	0.0	Hz
A022	Multi-step speed reference 2			
A023	Multi-step speed reference 3			
A024	Multi-step speed reference 4			
A025	Multi-step speed reference 5			
A026	Multi-step speed reference 6			
A027	Multi-step speed reference 7			
A028	Multi-step speed reference 8			
A029	Multi-step speed reference 9			
A030	Multi-step speed reference 10			
A031	Multi-step speed reference 11			
A032	Multi-step speed reference 12			
A033	Multi-step speed reference 13			
A034	Multi-step speed reference 14			
A035	Multi-step speed reference 15			

* To switch to the 2nd multi-step speed reference 0, allocate 08 (SET) to the multi-function input and then turn it on.

- By allocating 02 to 05 (CF1 to CF4) to multi-function inputs, you can select multi-step speeds 0 to 15.
Note that multi-step speed terminals not allocated to any multi-function input are regarded as "OFF". (e.g., if 02 (CF1) and 03 (CF2) are allocated to multi-function inputs, the available multi-step speeds are 0 to 3.)
- For speed 0, you can change the frequency reference with the frequency reference selection (A001). (e.g., if the frequency reference is set to the control terminal block (terminal, A001: 01), you can change it via input terminals FV and FI.)
- For speed 0, use A020/A220 if the frequency reference is set to the Digital Operator (A001: 02).
- Use A021 to A035 to set frequencies for speeds 1 to 15.

- You can also select a multi-step speed by turning on/off the multi-step speed terminals (CF1 to CF4) and set the multi-step speed frequency with F001.

Multi-step speed	Multi-step speed terminals			
	CF4	CF3	CF2	CF1
0th	OFF	OFF	OFF	OFF
1st			ON	
2nd			OFF	
3rd		ON	ON	OFF
4th			ON	OFF
5th			ON	ON
6th			ON	OFF
7th	ON	ON		
8th	ON	OFF	OFF	OFF
9th			ON	
10th			ON	OFF
11th		ON	OFF	ON
12th			ON	ON
13th			ON	OFF
14th		ON	ON	ON
15th			ON	ON

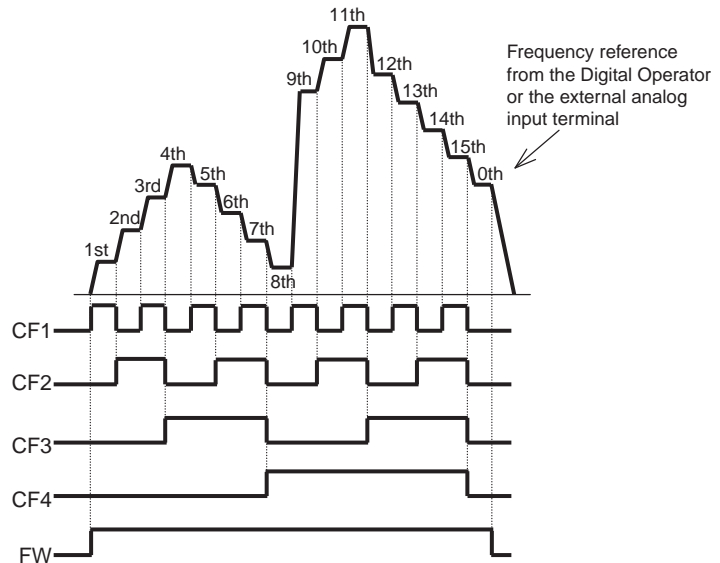

Jogging Operation Function

- The motor rotates while the input is turned ON.

Data	Symbol	Function name	Status	Description
06	JG	Jogging operation	ON	Operates at the set jogging frequency.
			OFF	Stop
Available input terminals		C001, C002, C003, C004, C005, C006		
Required settings		A002 = 01, A038 > b082, A038 > 0, A039		
Parameter No.	Function name	Data	Default setting	Unit
A038	Jogging frequency	0.00/Starting frequency to 9.99	6.00	Hz
A039	Jogging stop selection	00: Free-run stop 01: Deceleration stop 02: DC injection braking stop	00	Hz

- Allocate 06 (JG) to the desired multi-function input.

■ Jogging Frequency

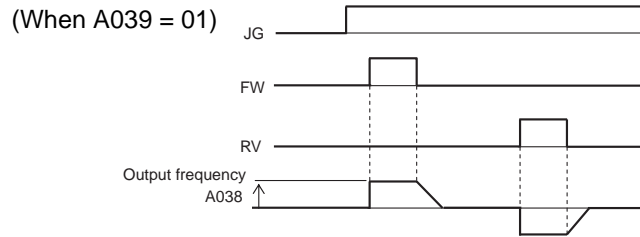

- The Inverter may easily lead to a trip if the jogging frequency is set to high. Adjust A038 so that the Inverter does not trip.

■ Jogging Stop Selection

- The deceleration time depends on the currently selected deceleration time in F003, F203, A093, or A293. When switching to normal operation, turn off the JG terminal after the deceleration time elapses, and enter the RUN command again.

Note1: To perform the jogging operation, turn on the JG terminal before the FW or RV terminals. (Do the same if the RUN command source is set to the Digital Operator.)

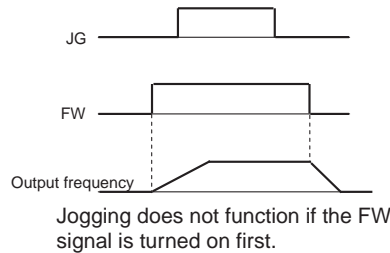

Note 2: If A039 is set to 02, data setting for the DC injection braking is required.

2nd Control Function and Special 2nd Function

- This function is used to operate by switching two different types of motors.

Data	Symbol	Function name	Status	Description
08	SET	2nd control	ON	Enables the parameter for the 2nd motor.
			OFF	Disables the parameter for the 2nd motor.
53	SP-SET	Special 2nd function	ON	Enables the parameter for the special 2nd motor.
			OFF	Disables the parameter for the special 2nd motor.
Available input terminals		C001, C002, C003, C004, C005		

- By allocating 08 (SET) or 53 (SP-SET) to the desired multi-function input and then turning on/off the SET or SP-SET terminal, you can switch and control two different motors.
- Switch to the 2nd control function at the SET terminal after turning off the RUN command and the Inverter output.
- You can switch to the 2nd control function at the SP-SET terminal during operation.

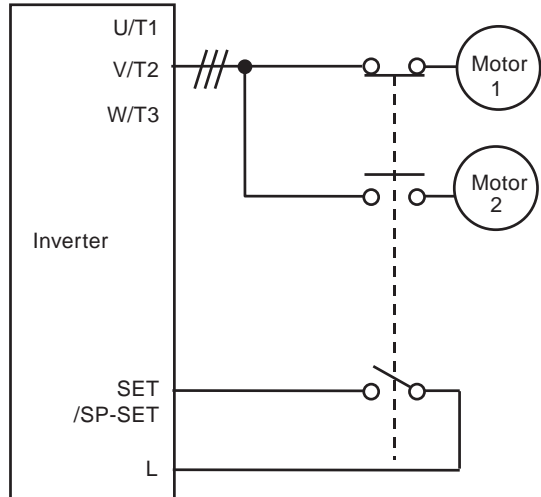

- To display and set each parameter for the 2nd control (200s of function codes), allocate SET and SP-SET.
- Parameters changeable during operation are as follows:

Parameter No.	Function name	Selection	
		SET	SP-SET
F002/F202	Acceleration time 1	Yes	Yes
F003/F203	Deceleration time 1	Yes	Yes
A001/A201	Frequency reference selection	No	Yes
A002/A202	RUN command selection	No	Yes
A003/A203	Base frequency	No	Yes
A004/A204	Maximum frequency	No	Yes
A020/A220	Multi-step speed reference 0	Yes	Yes
A042/A242	Manual torque boost voltage	Yes	Yes
A043/A243	Manual torque boost frequency	Yes	Yes
A044/A244	V/f characteristics selection	No	Yes
A045/A245	Output voltage gain	No	Yes
A046/A246	Automatic torque boost voltage compensation gain	No	Yes
A047/A247	Automatic torque boost slip compensation gain	No	Yes
A061/A261	Frequency upper limit	Yes	Yes
A062/A262	Frequency lower limit	Yes	Yes
A092/A292	Acceleration time 2	Yes	Yes
A093/A293	Deceleration time 2	Yes	Yes
A094/A294	2-step acceleration/deceleration selection	Yes	Yes
A095/A295	2-step acceleration frequency	Yes	Yes
A096/A296	2-step deceleration frequency	Yes	Yes
b012/b212	Electronic thermal level	No	Yes
b013/b213	Electronic thermal characteristics selection	No	Yes
b021/b221	Overload limit selection	No	Yes

Parameter No.	Function name	Selection	
		SET	SP-SET
b022/b222	Overload limit level	No	Yes
b023/b223	Overload limit parameter	No	Yes
b028/b228	Overload limit source selection	No	Yes
C001/C201	Multi-function input 1 selection	No	Yes
C002/C202	Multi-function input 2 selection	No	Yes
C003/C203	Multi-function input 3 selection	No	Yes
C004/C204	Multi-function input 4 selection	No	Yes
C005/C205	Multi-function input 5 selection	No	Yes
C006/C206	Multi-function input 6 selection	No	Yes
C041/C241	Overload warning level	No	Yes
H003/H203	Motor capacity selection	No	Yes
H004/H204	Motor pole number selection	No	Yes
H006/H206	Stabilization parameter	No	Yes
H007/H207	Motor voltage selection	No	Yes

- There's no indication of 2nd control functions on the display. You'll see which one is enabled by checking whether the terminal is turned on/off.
- Switch the SET terminal during stop or free run status, not during operation.

External Trip

Use this function to trip the Inverter according to the peripheral system conditions.

Data	Symbol	Function name	Status	Description
12	EXT	External trip	ON	Sets the motor to free-run status by shutting off output.
			OFF	The motor is in normal operation.
Available input terminals		C001, C002, C003, C004, C005, C006		

- When the EXT terminal is turned on, E12 is displayed and the Inverter trips to stop output.
- Allocate 12 (EXT) to the desired multi-function input.

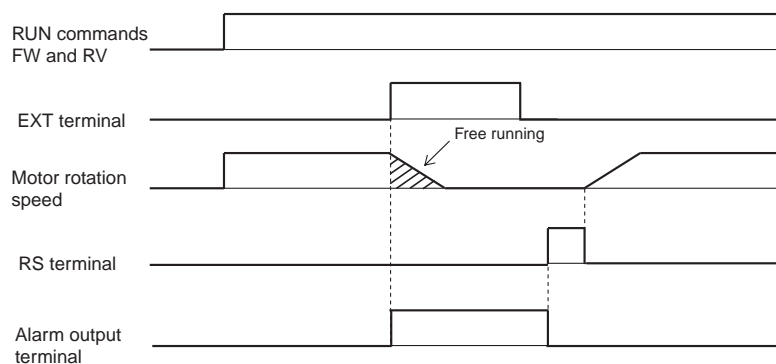

Power Recovery Restart Prevention Function

For safety reasons, this function causes a USP trip (E13) while the RUN command (FW/RV) from the control terminal (terminal) is turned on, in either of the following conditions:

- When the power is turned on
- After an undervoltage trip is reset

Data	Symbol	Function name	Status	Description
13	USP	USP function	ON	Does not start the Inverter with the power turned on while the RUN command is input.
			OFF	Starts the Inverter with the power turned on while the RUN command is input.
Available input terminals		C001, C002, C003, C004, C005, C006		

- You can reset a USP trip by turning off the RUN command (example 1) or resetting the Inverter. The Inverter starts running immediately after a trip reset if the RUN command is still turned on. (Example 2)
- To return from a USP trip to normal operation, shut off the power, turn off the RUN command, turn on the power again, and then turn on the RUN command. (Example 3)
- Allocate 13 (USP) to the desired multi-function input.
- The following shows how this function works.

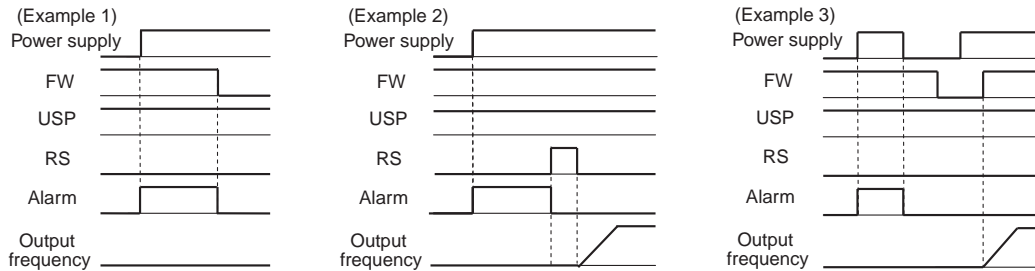

Soft Lock Function

Use this function to prohibit rewriting of each parameter. This helps prevent data rewriting due to erroneous operation.

Data	Symbol	Function name	Status	Description
15	SFT	Soft lock	ON	Rewriting is unacceptable except for specified parameters.
			OFF	Depends on the b031 setting.
Available input terminals		C001, C002, C003, C004, C005, C006		
Required settings		b031 (soft lock excluded)		

- Allocate 15 (SFT) to the desired multi-function input.

Reset

This function resets an Inverter trip.

Data	Symbol	Function name	Status	Description
18	RS	Reset	ON	Shuts off the power if the Inverter is running. Cleared at trip. (The same process as when the power is turned on)
			OFF	Same as above.
Available input terminals		C001, C002, C003, C004, C005, C006		
Required settings		C102		

- You can also reset an Inverter trip by pressing the STOP/RESET key on the Digital Operator.
- In reset selection C102, you can select alarm reset timing and either enable/disable in normal operation.
- For the RS terminal, only NO contact is available.

Parameter No.	Function name	Data	Description
C102	Reset selection	00	Trip reset at power-on (example 1) Enabled during normal operation (shuts off output)
		01	Trip reset at power-off (example 2) Enabled during normal operation (shuts off output)
		02	Trip reset at power-on (example 1) Disabled during normal operation (trip reset only)

(Example 1)

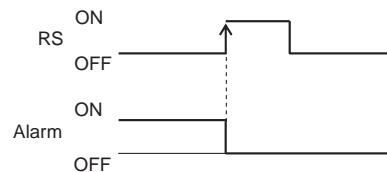

(Example 2)

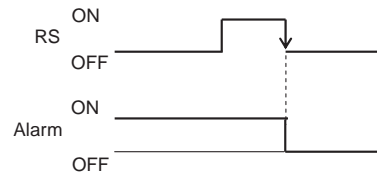

Thermistor Trip Function

This function protects the motor by tripping with the built-in thermistor detecting a temperature rise.

Data	Symbol	Function name	Status	Description
19	PTC	Thermistor input	Connected	When the thermistor is connected between terminals S5 and SC, the Inverter can detect motor temperature and, if the temperature exceeds the specified level, trips to shut off the output (E35). The level is fixed.
			Open	If the thermistor is not connected, the Inverter trips (E35) to shut off the output even with this function selected.
Available input terminals		C006 only		

- Allocate 19 (PTC) to multi-function input 5 (C005). This cannot be used with other multi-function inputs. (Use a thermistor with the PTC characteristics.)
- Trip level is fixed at $3\text{ k}\Omega \pm 10\%$ max. For how to connect the thermistor, refer to "Functions of the Control Circuit Terminals" (page 2-26).

3-wire Input Function

- This function is effective in using auto recovery contacts such as a press button switch for operation and stop.

Data	Symbol	Function name	Status	Description
20	STA	3-wire start	ON	Starts with auto recovery contacts.
			OFF	Irrelevant to the motor operation.
21	STP	3-wire stop	ON	Stops with auto recovery contacts.
			OFF	Irrelevant to the motor operation.
22	F/R	3-wire forward/reverse	ON	Reverse
			OFF	Forward
Available input terminals		C001, C002, C003, C004, C005, C006		
Required settings		A002 = 01		

- Set RUN command selection A002 to 01 (control terminal).
- The following operations become possible with 20 (STA), 21 (STP), and 22 (F/R) allocated to the multi-function inputs. With the STA and STP terminals allocated, the FW and RV terminals are disabled.
- Below are the outputs via terminal operation.

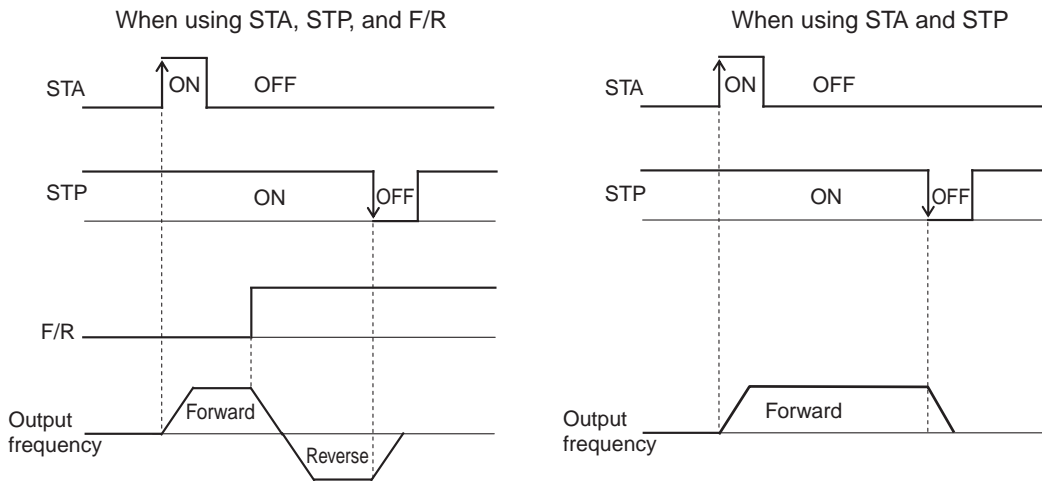

UP/DOWN Function

This function changes the Inverter output frequency using the multi-function input.

Data	Symbol	Function name	Status	Description
27	UP	UP/DWN function accelerated	ON	Increases the current speed during the signal input period.
			OFF	Keeps the current speed.
28	DWN	UP/DWN function decelerated	ON	Decreases the current speed during the signal input period.
			OFF	Keeps the current speed.
29	UDC	UP/DWN function data clear	ON	Clears the stored UP/DWN speed.
			OFF	Keeps the stored UP/DWN speed.
Available input terminals		C001, C002, C003, C004, C005, C006		
Required settings		A001 = 02, C101		

- While the UP/DWN terminal is turned on, the acceleration/deceleration time depends on F002, F003/F202, and F023. To switch to the 2nd control, allocate 08 (SET) to the multi-function input and then turn on/off the SET terminal.
- You can store a frequency set value after UP/DWN adjustment. Choose whether to store the value with C101.
Also, you can clear the stored frequency set value by allocating 29 (UDC) to the desired multi-function input and turning on/off the UDC terminal.

UP/DOWN Function Enabled/Disabled

Frequency reference selection (A001)	Multi-step speed	Jogging	Enabled/Disabled
—	—	ON	Disabled
—	ON	OFF	Enabled
00	OFF	OFF	Disabled
01	OFF	OFF	Disabled
02	OFF	OFF	Enabled
03	OFF	OFF	Disabled

- The UP/DOWN function is disabled when the JG operation (06) is enabled.
- The UP/DOWN function is enabled when the frequency reference selection (A001) is set to the Digital Operator (02).
- The UP/DOWN function is enabled when the multi-step speed reference is enabled.

Parameter No.	Function name	Data	Description
C101	UP/DWN selection	00	Does not store the frequency reference adjusted using UP/DWN. After restoring the power, returns to the value set before UP/DWN adjustment.
		01	Stores the frequency reference adjusted using UP/DWN. After restoring the power, maintains the set value after UP/DWN adjustment.

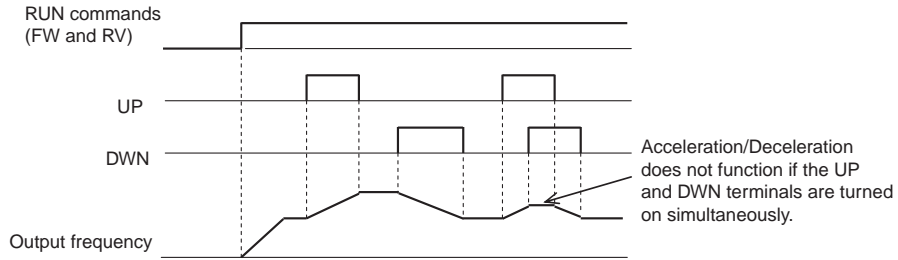

Forced Operator Function

4

This function forcibly switches to operation via the Digital Operator by turning on/off the multi-function terminal if the frequency reference/RUN command sources are not set to the Digital Operator.

Data	Symbol	Function name	Status	Description
31	OPE	Forced operator	ON	Prioritizes the command from the Digital Operator (A020, A220 set values) over the A001 and A002 settings.
			OFF	Operates according to the A001 and A002 settings.
Available input terminals		C001, C002, C003, C004, C005, C006		
Related codes		A001, A002		

- If you switch on/off this function during operation, the RUN command is reset to stop the Inverter. Before resuming operation, stop the RUN command from each command source to avoid possible danger and then input it again.

Frequency Addition Function

This function allows you to add/subtract the constant offset frequency to/from the output frequency.

Data	Symbol	Function name	Status	Description
50	ADD	Frequency addition	ON	Calculates the set value in A145 against the set frequency in A001 as specified in A146, in order to provide a new frequency reference.
			OFF	Normal control
Available input terminals		C001, C002, C003, C004, C005, C006		
Required settings		A001, A145, A146		
Related codes		A001, A002		

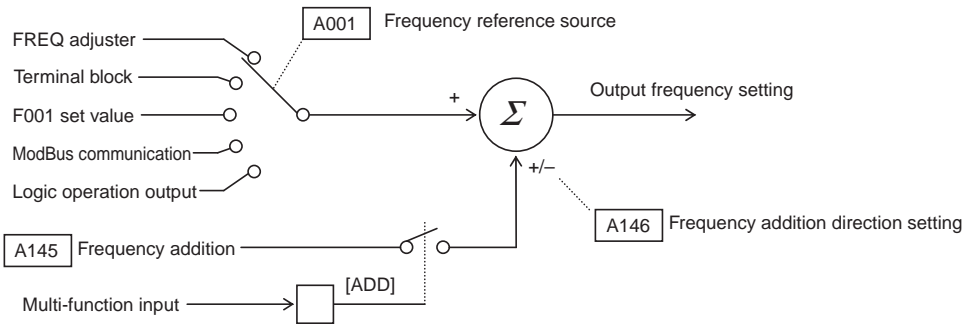

Forced Terminal Block Function

This function forcibly switches to operation via the terminal block by turning on/off the multi-function terminal when the frequency reference/RUN command sources are not set to the terminal block.

Data	Symbol	Function name	Status	Description
51	F-TM	Forced terminal block	ON	Forcibly sets to A001 = 01 and A002 = 01.
			OFF	Operates according to the A001 and A002 settings.
Available input terminals		C001, C002, C003, C004, C005, C006		
Required settings		A001, A002		

- When the input of this signal is reset, A001 and A002 return to the command status prior to the input.
- If you switch on/off this function during operation, the RUN command is reset to stop the Inverter. Before resuming operation, stop the RUN command from each command source to avoid possible danger and then input it again.

Ready Function

Data	Symbol	Function name	Status	Description
52	RDY	Ready function	ON	The Inverter is ready.
			OFF	Normal stop status
Available input terminals		C001, C002, C003, C004, C005, C006		

- Inputting this signal shortens the time between the RUN command input and the start of actual operation. In normal status, this is approx. 20 ms. Shortened time through this function varies depending on timing.

When the Inverter is in ready status, high voltage is applied to terminals U, V, and W on the main circuit terminal block. This happens even if the motor is stopped with the RUN command turned off. Do not touch the main circuit terminal block.

Multi-function Output Selection

Parameter No.	Function name	Data	Default setting	Unit
C021	Multi-function output terminal P1 selection	00: RUN (signal during RUN) 01: FA1 (constant speed arrival signal) 02: FA2 (over set frequency arrival signal)	00	—
C022	Multi-function output terminal P2 selection	03: OL (overload warning) 04: OD (excessive PID deviation) 05: AL (alarm output) 06: Dc (disconnection detected)	01	—
C026	Relay output (MA, MB) function selection	07: FBV (PID FB status output) 08: NDc (network error) 09: LOG (logic operation output)	05	—

- You can allocate the following functions to multi-function output terminals P1, P2 and the relay output terminals.
- Multi-function output terminals P1 to P2 provide open-collector output. The relay output terminal provides SPDT contact relay output.
- You can select NO- or NC-contact output for each output terminal with C031 to C032 or C036.

Data	Description	Reference item	Page
00	RUN: Signal during RUN	Signal during RUN	4-54
01	FA1: Constant speed arrival signal	Frequency arrival signal	4-54
02	FA2: Over set frequency arrival signal		
03	OL: Overload warning	Overload limit/Overload warning	4-55
04	OD: Excessive PID deviation	PID function	4-56
05	AL: Alarm output	—	4-57
06	DC: Disconnection detection	External analog input disconnection detection	4-57
07	FBV: PID FB status output	PID function	4-59
08	NDC: Network error	Network error	4-59
09	LOG: Logic operation output	Logic operation function	4-60

Signal During RUN

This function outputs a signal while the Inverter is running.

Data	Symbol	Function name	Status	Description
00	RUN	Signal during RUN	ON	The Inverter is in RUN mode.
			OFF	The Inverter is in STOP mode.
Available input terminals		P1-PC, P2-PC, MA-MC (or MB-MC)		
Required settings		C021, C022, C026		

•This signal is also output during DC injection braking. Below is the time chart.

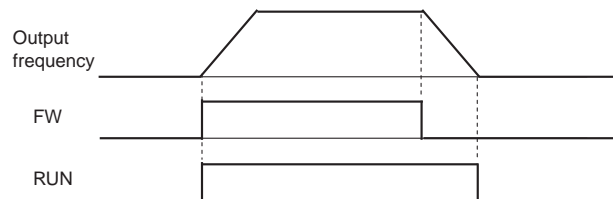

Frequency Arrival Signal

•This function outputs a signal when the output frequency has reached the set value. For elevating machines, use this signal for applying the brake.

Data	Symbol	Function name	Status	Description
01	FA1	Constant speed arrival signal	ON	The Inverter output frequency has reached the F001 set value.
			OFF	The Inverter output frequency has fallen below the F001 set value.
02	FA2	Over set frequency arrival signal	ON	The Inverter output frequency has exceeded the C042 set value during acceleration.
			OFF	The Inverter output frequency has fallen below the C042 set value during acceleration.
Available input terminals		P1-PC, P2-PC, MA-MC (or MB-MC)		
Required settings		C021, C022, C026, C042, C043		

•Below is the hysteresis of the frequency arrival signal.

ON: (Set frequency - 1% of the maximum frequency) (Hz)

OFF: (Set frequency - 2% of the maximum frequency) (Hz)

Parameter No.	Function name	Data	Default setting	Unit
C042	Arrival frequency during acceleration	0.0: Does not output arrival signal during acceleration 0.1 to 400.0: Outputs arrival signal during acceleration	0.0	Hz
C043	Arrival frequency during deceleration	0.0: Does not output arrival signal during deceleration 0.1 to 400.0: Outputs arrival signal during deceleration	0.0	Hz

■ Constant Speed Arrival Output (01: FA1)

- Outputs a signal when the output frequency has reached the level set in the frequency setting (F001, A020, and A220) or multi-step speed (A021 to A035).

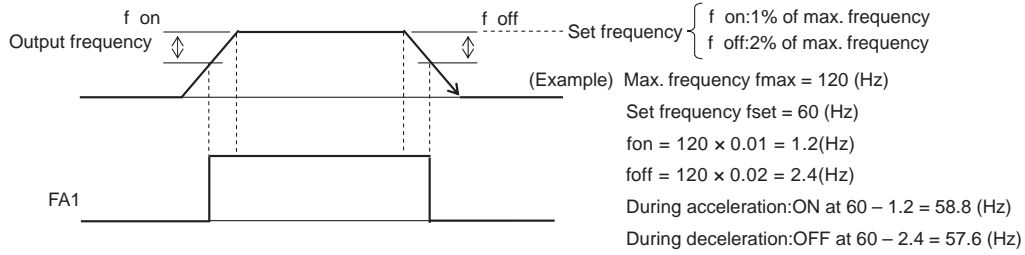

■ Output Over Set Frequency (02: FA2)

- Outputs a signal when the output frequency has exceeded the arrival frequencies during acceleration/deceleration set in [C042, C043 (FA2)].

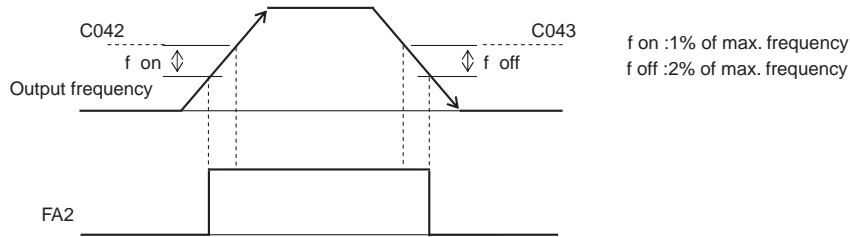

Overload Warning

If the load is too large, this function outputs an overload warning signal, allowing you to readjust the overload level to prevent a trip.

This helps prevent mechanical damage due to an overload in the conveyors, or an operation line stop due to an overload trip of the Inverter.

Data	Symbol	Function name	Status	Description
03	OL	Overload warning	ON	The Inverter output current has exceeded the C041 set value.
			OFF	The Inverter output current has not reached the C041 set value.
Available input terminals		P1-PC, P2-PC, MA-MC (or MB-MC)		
Required settings		C021, C026, C041		
Parameter No.	Function name	Data	Default setting	Unit
C041	Overload warning level	0.0: Does not operate. 0.1 to Rated current × 200%: Outputs OL signal when reaching the overload warning level.	Rated current	A

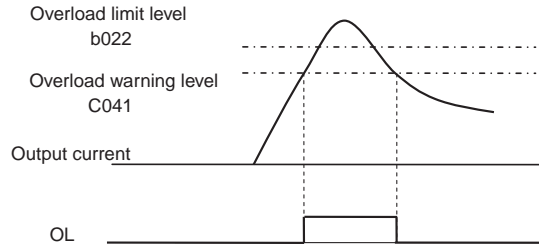

Excessive PID Deviation Output

This function outputs a signal when the deviation has exceeded the set value during the use of the PID function.

Data	Symbol	Function name	Status	Description
04	OD	Excessive PID deviation	ON	The PID deviation has exceeded the C044 set value.
			OFF	The PID deviation has not reached the C044 set value.
Available input terminals		P1-PC, P2-PC, MA-MC (or MB-MC)		
Required settings		C021, C026, C044		
Parameter No.	Function name	Data	Default setting	Unit
C044	PID deviation excessive level	0.0 to 100.0	30.	%

•C044 can be set from 0 to 100. The setting corresponds to the range of 0 to the maximum target value.

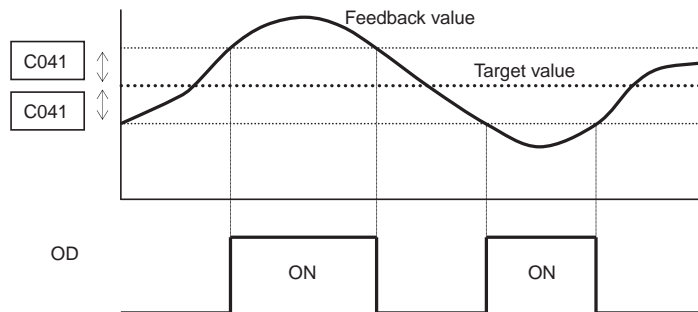

Alarm Output

This is output when the Inverter trips. If you use the relay for alarm outputs, set and check operation, as the SPDT contact is used for the terminals. For details, refer to the description of the relay output, "Multi-function Output Terminal ON Delay/OFF Delay" (page 4-61).

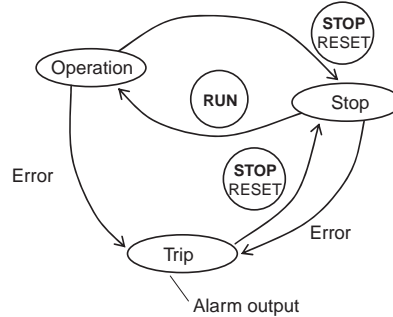

Data	Symbol	Function name	Status	Description
05	AL	Alarm output	ON	The Inverter is in trip status.
			OFF	The Inverter is normal.
Available input terminals		P1-PC, P2-PC, MA-MC (or MB-MC)		
Required settings		C021, C026		

External Analog Input Disconnection Detection

•Outputs a signal if an error is detected in the external analog inputs (FV, FI).

Data	Symbol	Function name	Status	Description
06	Dc	Disconnection detection	ON	The Inverter is in trip status.
			OFF	The Inverter is normal.
Available input terminals		P1-PC, P2-PC, MA-MC (or MB-MC)		
Required settings		C021, C022, C026, A001, A005		

- The disconnection detection signal is output if the frequency reference of the external analog input remains below the starting frequency for 500 ms or more.
- The signal stops 500 ms after the frequency reference has exceeded the starting frequency.
- Helps detect disconnection when a frequency reference is issued from the external analog inputs (FV, FI) with the frequency reference selection set to the terminal (A001 = 01).

- Enabled only when the external analog inputs (FV, FI) are selected.
Example 1: Disabled in multi-step speed operation even when the frequency reference is set to the external analog input (A001 = 01).
Example 2: Disabled even when the FV/FI selection is set to the FV/VR selection (A005 = 02) or FI/VR selection (A005 = 03) since the frequency reference is set on the Digital Operator (volume) with the AT terminal turned on.

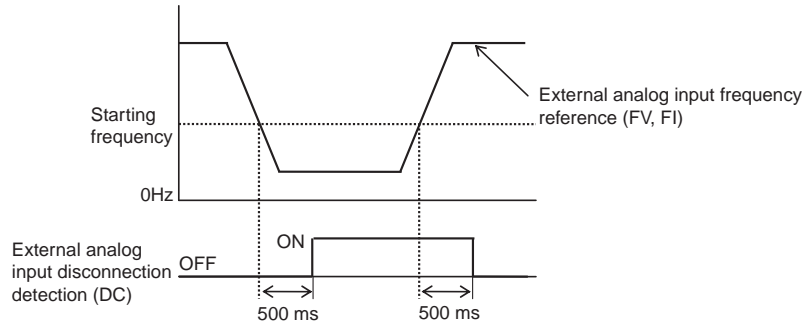

PID FB Status Output

When the PID function is used, this function outputs a signal according to the FB value, as illustrated below.

This is effective as a RUN command in operating multiple pumps.

Data	Symbol	Function name	Status	Description
07	FBV	PID FB status output	ON	See the figure below. Shifts output when exceeding the upper limit or falling below the lower limit.
			OFF	
Available input terminals		P1-PC, P2-PC, MA-MC (or MB-MC)		
Required settings		C021, C026, C052, C053		

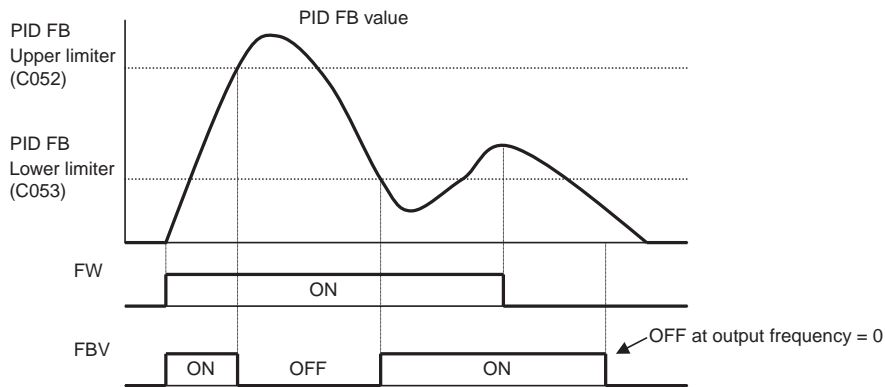

Network Error

This function detects and outputs a network error during RS485 ModBus communication.

- The error is output during RS485 ModBus communication if the next signal does not come even after the specified time period set in C077.

Data	Symbol	Function name	Status	Description
08	NDc	Network error	ON	The communication watchdog timer times out.
			OFF	Normal
Available input terminals		P1-PC, P2-PC, MA-MC (or MB-MC)		
Required settings		C021, C026, C052, C077		

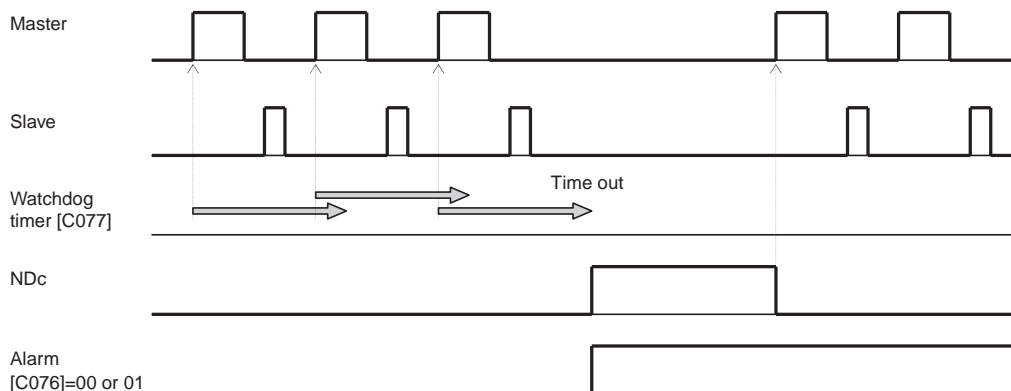

Logic Operation Output

This function outputs a logic operation result of the set two status.

Data	Symbol	Function name	Status	Description
09	LOG	Logic operation output	ON	See the figure below.
			OFF	
Available input terminals		P1-PC, P2-PC, MA-MC (or MB-MC)		
Required settings		C021, C026, C141, C142, C143		

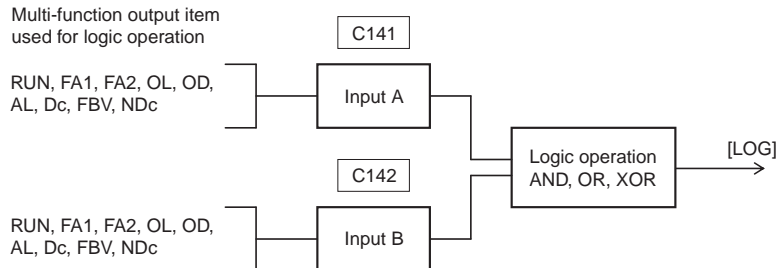

Logic Output Function

This function outputs the logic operation result of the two multi-function outputs.

Allocate "10" (LOG logic output) to multi-function output terminal P1 or P2, or the relay output terminal.

Parameter No.	Function name	Data	Description
C141/C142	Logic operation function A, B input	00 to 10	Selects the logic operation target from 00 (RUN), 01 (FA1), 02 (FA2), 03 (OL), 04 (OD), 05 (AL), 06 (DC), 07 (FBV), 08 (NDC)
C143	Logic operator selection	00	Logical conjunction (AND)
		01	Logical disjunction (OR)
		02	Exclusive disjunction (XOR)

Multi-function Output Terminal ON Delay/OFF Delay

This function allows you to set ON/OFF delay times respectively from 0.1 to 100 seconds at the signal output of the multi-function output terminals (P1 and relay). The following figure shows the output status.

Parameter No.	Function name	Data	Default setting	Unit
C144	Output terminal P1 ON delay	0.0 to 100.0	0.0	s
C145	Output terminal P1 OFF delay	0.0 to 100.0	0.0	s
C146	Output terminal P2 ON delay	0.0 to 100.0	0.0	s
C147	Output terminal P2 OFF delay	0.0 to 100.0	0.0	s
C148	Relay output ON delay	0.0 to 100.0	0.0	s
C149	Relay output OFF delay	0.0 to 100.0	0.0	s

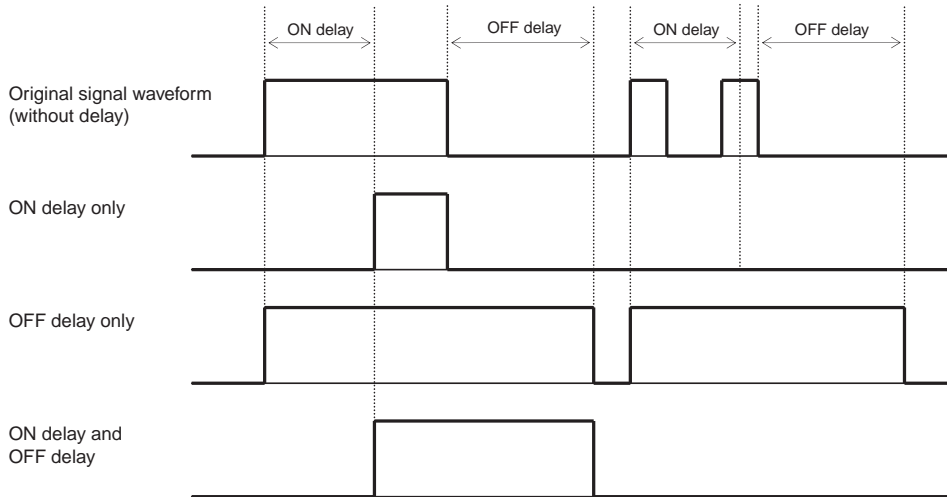

Multi-function Output Contact Selection

- You can set NO- or NC-contact output individually for multi-function output terminals P1 to P2 as well as the relay output terminal.
- Multi-function output terminals P1 to P2 provide open-collector output. The relay output terminal provides SPDT contact relay output.

Parameter No.	Function name	Data	Default setting	Unit
C031 to C032	Multi-function output terminals P1, P2 contact selection	00: NO contact 01: NC contact	00	—
C036	Relay output (MA, MB) contact selection	00: NO contact between MA and MC 01: NC contact between MA and MC	01	—

■ Specifications of Multi-function Output Terminals P1, P2

•Below are the specifications of multi-function output terminals P1, P2.

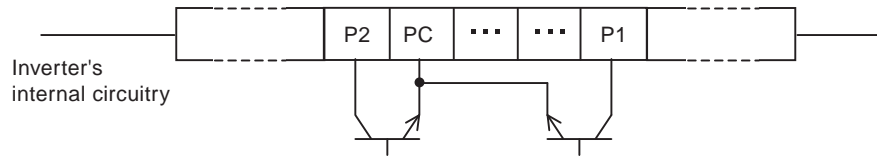

C031 to C032 set values	Power supply	Output status	Electrical specifications
00 (NO contact)	ON	ON	
	ON	OFF	
01 (NC contact)	OFF	—	
	OFF	—	

- Connect multi-function output terminals P1 and P2 at the same sink/source logics.
- The PC terminal acts as a common terminal at sink/source logics.

■ Relay Output Contact Selection

•The relay output terminal has an SPDT contact configuration. Below is the operation.

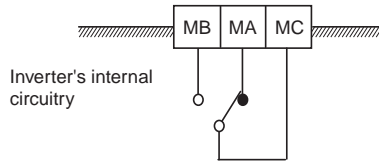

Electrical specifications

Output terminal		Resistance load	Inductive load
MA-MC	Max. contact capacity	250 V AC, 2 A 30 V DC, 3 A	250 V AC, 0.2 A 30 V DC, 0.6 A
	Min. contact capacity	100 V AC, 10 mA 5 V DC, 100 mA	
MB-MC	Max. contact capacity	250 V AC, 1 A 30 V DC, 1 A	250 V AC, 0.2 A 30 V DC, 0.2 A
	Min. contact capacity	100 V AC, 10 mA 5 V DC, 100 mA	

(a) When used as an alarm terminal

C036 set value	Power supply	Inverter status	Output terminal status	
			MA-MC	MB-MC
00	ON	Abnormal	Closed	Open
		Normal	Open	Closed
	OFF	—	Open	Closed
01	ON	Abnormal	Open	Closed
		Normal	Closed	Open
	OFF	—	Open	Closed

(b) When used as an output terminal

C036 set value	Power supply	Output signal	Output terminal status	
			MA-MC	MB-MC
00	ON	ON	Closed	Open
		OFF	Open	Closed
	OFF	—	Open	Closed
01	ON	ON	Open	Closed
		OFF	Closed	Open
	OFF	—	Open	Closed

Analog Output AM Terminal

- This function allows you to monitor the output frequency and current from the AM terminal on the control terminal block (terminal).
- The AM terminal provides 0- to 10-V analog output.
- For how to connect the AM terminal, refer to page 2-26.

■ AM Selection

- Select a signal to output from the following table.

Parameter No.	Function name	Data	Default setting	Unit
C028	AM selection	00: Output frequency 0 to 10 V (0 to Max. frequency (Hz)) 01: Output current 0 to 10 V (0% to 200% of the rated current)	00	—

■ AM Adjustment

- Adjust the calibration of the meter connected to the AM terminal by using the Inverter setting.

Parameter No.	Function name	Data	Default setting	Unit
b080	AM adjustment	0. to 255. (Adjust to the scale)	100.	—
C086	AM offset adjustment	0.0 to 10.0 (See the section below)	0.0	V

(a) AM adjustment value change

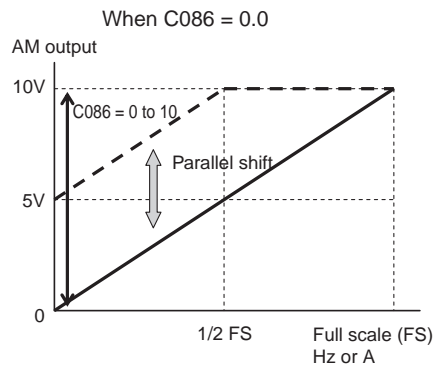
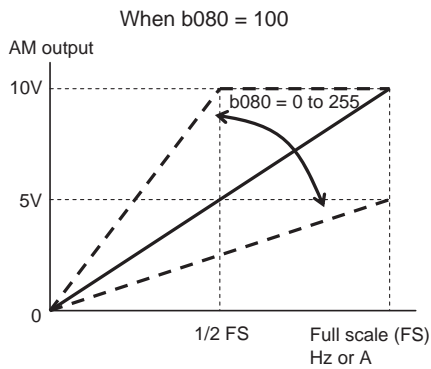

<Group H: Motor Control Parameters>

Motor Capacity, Pole Number and Motor Voltage

Set the capacity, number of poles and voltage of the motor connected to the Inverter.

•With incorrect parameters set, appropriate operation cannot be ensured.

Parameter No.	Function name	Data	Default setting	Unit
H003	Motor capacity selection	200-V class 0.2/0.4/0.75/1.5/2.2/3.7/5.5/7.5	Factory default	kW
*H203	2nd motor capacity selection	400-V class 0.4/0.75/1.5/2.2/3.7/5.5/7.5	Factory default	kW
H004	Motor pole number selection	2/4/6/8	4	Pole
*H204	2nd motor pole number selection		4	Pole
H007	Motor voltage selection	00: 200 V	Factory default	—
*H207	2nd motor voltage selection	01: 400 V	Factory default	—

* To switch to the 2nd control, allocate 08 (SET) to the multi-function input and then turn it on.

Stabilization Parameter

This function adjusts to reduce motor hunting.

Parameter No.	Function name	Data	Default setting	Unit
H006	Stabilization parameter	0. to 255.	100	—
*H206	2nd stabilization parameter		100	—
Related functions		A045, b083		

* To switch to the 2nd control, allocate 08 (SET) to the multi-function input and then turn it on.

- In case of motor hunting, check whether the motor capacity selection (H003/H203) and motor pole number selection (H004/H204) match your motor. If they do not, match them.
- For adjustment, raise the stabilization parameter (H006) by degrees. If this increases motor hunting, lower it by degrees.
- When using the automatic torque boost (A044/A244 = 02), if motor hunting occurs in a low speed range, lower the manual torque boost voltage (A042/A242) and manual torque boost frequency (A043/A243).
- Other than this function, the following methods are suggested to reduce hunting:

Lower the carrier frequency (b083)

Lower the output voltage gain (A045)

Parameter No.	Function name	Data	Description
A045	Output voltage gain	20. to 100.	Unit: % (Lower this in motor hunting.)
b083	Carrier frequency	2.0 to 14.0	Unit: kHz (Lower this in motor hunting.)
H006/H206	Stabilization parameter	0. to 255.	Adjust this in motor hunting.

Communication Function

- Communication with external network control devices can be carried out from the communication connector of the 3G3MX Series Inverter, through the RS-485 complying ModBus-RTU protocol.

■Communication Specifications

Function name	Description	Note
Transmission speed	4800/9600/19200 bps	Select using the Digital Operator.
Synchronous system	Asynchronous system	
Transmission code	Binary	
Transmission mode	LSB first	
Compatible interface	RS-485	
Data bit length	8 bits (Modbus-RTU mode)	ASCII mode not available
Parity	No parity/Even/Odd	Select using the Digital Operator.
Stop bit length	1 or 2 bits	Select using the Digital Operator.
Starting method	One-way start using host command	
Wait time	Silent interval + 0 to 1000 [ms]	Set using the Digital Operator.
Connection	1:N (N = 32 max.)	Use the Digital Operator to select a station No.
Connector	RJ-45 modular jack	
Error check	Overrun/Framing/CRC-16/Horizontal parity	

<RS-485 Port Specifications and Connection>

The Modbus communication allows the Inverter to communicate with an external controller via the RS485 interface. Refer to the connection method as follows:

-Procedure-

1. Set the parameters of the Inverter in accordance with your communication environment.
2. Shut off the power.
3. Remove the attached Digital Operator, and remove the modular plug mounted in the communication connector.
4. Insert the communication cable connected to the ModBus bus line.
5. Set the 485/OPE communications selector to "485".
6. Turn on the power and start ModBus communications.

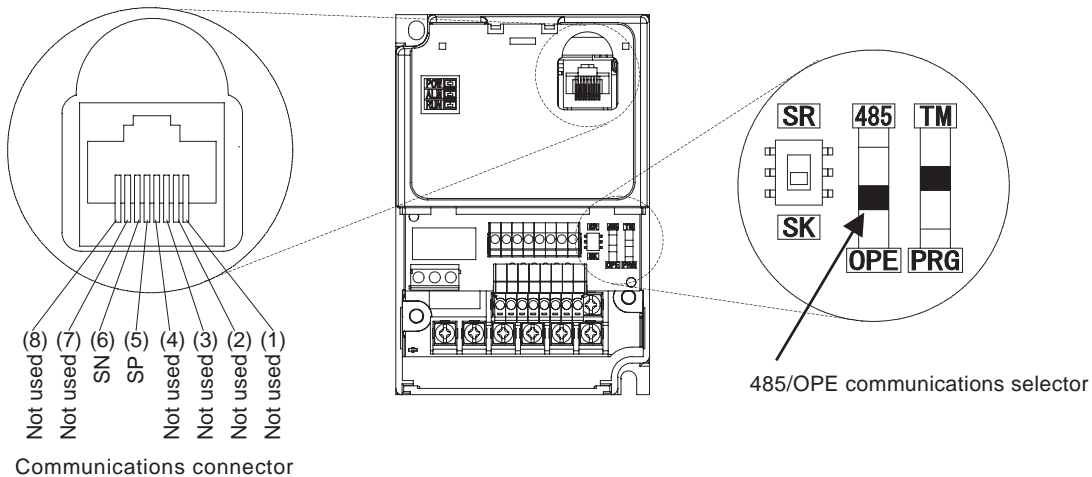

Details of each communications connector pin are shown below.

Pin No.:	Symbol	Description
(1)	—	Not used. Do not connect.
(2)	—	Not used. Do not connect.
(3)	—	Not used. Do not connect.
(4)	—	Not used. Do not connect.
(5)	SP	Sent and received data: Positive side
(6)	SN	Sent and received data: Negative side
(7)	—	Not used. Do not connect.
(8)	—	Not used. Do not connect.

Connect each Inverter in parallel as below. Connect a termination resistor separately to avoid signal reflection, since this 3G3MX does not incorporate it. Choose a termination resistor according to the impedance characteristics of the cable to be used.

Connection example where the external controller (master) incorporates a termination resistor

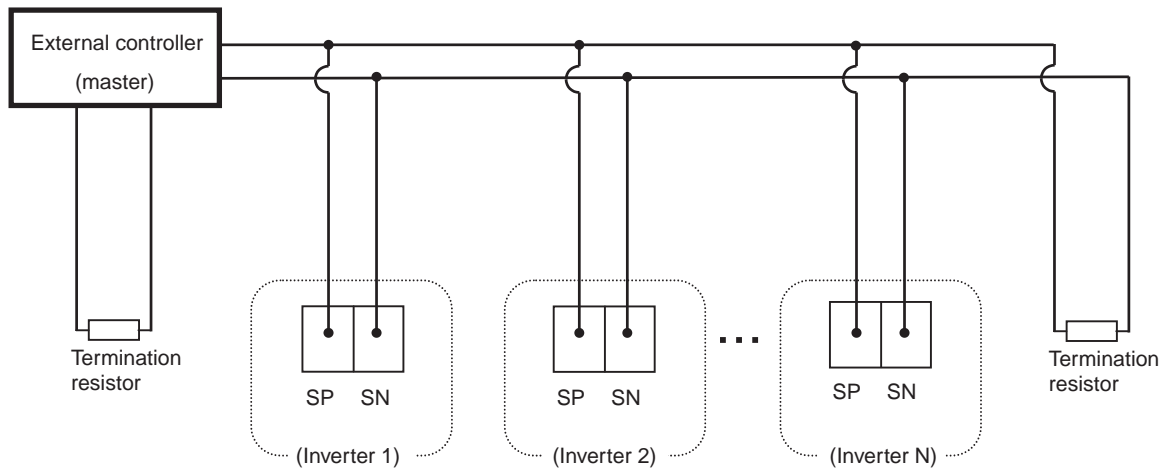

■Setting

ModBus communication requires the following settings. Be sure to set the parameters as shown below.

If the parameter settings are changed, the new settings are enabled at the point of change. However, ModBus communication will not start until "485" is selected with the 485/OPE selector and the Inverter is turned on again.

The parameters of C070s cannot be changed or set through ModBus communication. Set using the attached Digital Operator.

Parameter No.	Function name	Data	Default setting	Unit
A001	Frequency reference selection	00: Digital Operator (FREQ adjuster) 01: Terminal 02: Digital Operator (F001) 03: ModBus communication 10: Frequency operation result	00	—
A002	RUN command selection	01: Terminal 02: Digital Operator 03: ModBus communication	02	—
C071	Communication speed selection (Baud rate selection)	04: 4800 bps 05: 9600 bps 06: 19200 bps	04	—
C072	Communication station No. selection	1 to 32	1.	—
C074	Communication parity selection	00: No parity 01: Even 02: Odd	00	—
C075	Communication stop bit selection	1: 1 bit 2: 2 bits	1	—
C076	Communication error selection	00: Trip 01: Trip after deceleration stop 02: Ignore 03: Free run 04: Deceleration stop	02	—
C077	Communication error timeout	0.00 to 99.99	0.00	s
C078	Communication wait time	0 to 1000	0.	ms

Communication Procedure

- Follow the procedures below in regard to communication between the external control device and the Inverter.

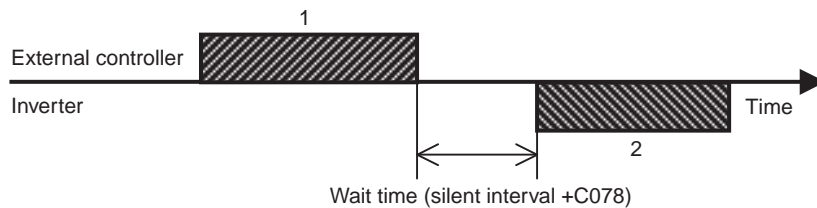

- 1: Frame to be sent from the external control device to the Inverter (Query)
- 2: Frame to be returned from the Inverter to the external control device (Response)

The Inverter returns a response (Frame (2)) only after receiving a query (Frame (1)) and does not output a response positively.

Below is each frame format (command).

Message Configuration: Query

Header (Silent interval)
Slave address
Function code
Data
Error check
Trailer (Silent interval)

<Slave Address>

- Pre-set numbers ranging from 1 to 32 in each Inverter (slave). (Only the Inverter having the same slave address as the query takes in the query.)
- Broadcasting can be performed by setting the slave address to "0".
- Data call or loopback cannot be performed while broadcasting.

<Data>

- Sends the function command.
- The 3G3MX Series corresponds with the following data formats used in the ModBus.

Data name	Description
Coil	Binary data (1-bit long) that can be referred to or changed
Holding register	16-bit long data that can be referred to or changed

<Function Code>

- Specifies a function for the Inverter to perform.
- Below are the function codes available to the 3G3MX Series.

Function code

Function code	Function	Maximum number of data bytes in 1 message	Maximum data number in 1 message
01h	Reading coil status	4	32 coils (in bits)
03h	Reading holding register content	8	4 registers (in bytes)
05h	Writing into the coil	2	1 coil (in bits)
06h	Writing into the holding register	2	1 register (in bytes)
08h	Loopback test	-	
0Fh	Writing into multiple coils	4	32 coils (in bits)
10h	Writing into multiple registers	8	4 registers (in bytes)

<Error Check>

- CRC (Cyclic Redundancy Check) is used for the Modbus-RTU error check.

- The CRC code is 16-bit data generated for the block of random length data in the 8-bit unit.
- To prepare the CRC code, use a generation polynomial of CRC-16 ($X^{16} + X^{15} + X^2 + 1$).

CRC-16 Calculation Example

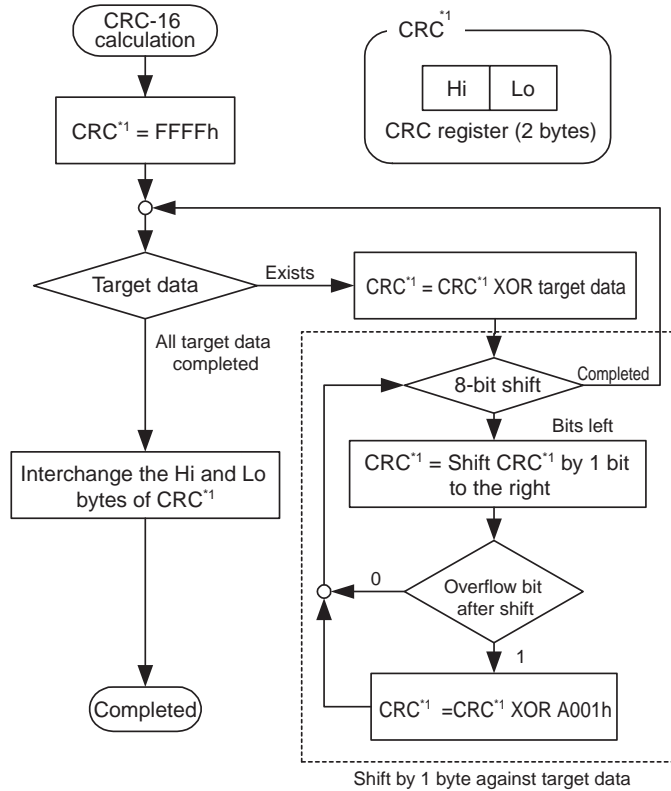

<Header and Trailer (Silent Interval)>

- Wait time between receiving the query from the master and the response by the Inverter.
- Be sure to provide 3.5 characters (24 bits) for wait time. If the length does not reach 3.5 characters, the Inverter does not respond.
- The actual communication wait time is the total of the silent interval (3.5-character length) and C078 (communication wait time) setting.

Message Configuration: Response

<Total Communication Time>

- The time between receiving query and the response by the Inverter is the total of the silent interval (3.5-character length) and C078 (communication wait time) setting.
- When sending another query to the Inverter after receiving the response from the Inverter, be sure to provide the silent interval length (3.5-character length or more) at the minimum.

<Normal Response>

- If the query is the loopback function code (08h), the Inverter sends back a response of the same content as the query.
- If the query contains a function code of writing into the holding register or coil (05h, 06h, 0Fh, 10h), the Inverter sends back the query as it is in response.
- If the query contains a function code of reading the holding register or coil (01h, 03h), the Inverter makes the slave address and function code the same as the query and attaches the read data to the query.

<Abnormal Response>

Field Configuration

Slave address
Function code
Exception code
CRC-16

- If an error (aside from a communication error) is found in the query content, the Inverter returns an exception response without performing any operation.
- To determine the cause of an error, check the function code of the response. The function code of the exception response is the value of the query function code with 80h added.
- Check the details of the error with the exception code.

Code	Description
01h	Has specified an unsupported function.
02h	Specified address does not exist.
03h	Specified data has an unacceptable format.
21h	Data is out of the Inverter's range for writing into the holding register.
22h	The Inverter does not allow this function. <ul style="list-style-type: none"> • Has attempted to change the register that cannot be changed during operation. • Has issued the enter command during operation (UV). • Has written into the register during trip (UV). • Has written into the read-only register (coil).

<No Response>

The Inverter ignores a query and does not respond if:

- The broadcast is received.
- A communication error is detected in receiving a query.
- The query slave address does not correspond with the slave address set for the Inverter.
- The time interval between 2 pieces of data constituting the message is less than a 3.5-character length.
- Query data length is inappropriate.

Note: Provide a timer in the master to monitor the response, and if no response is returned within the set time period, send the same query again.

■ Explanation of Each Function Code

<Reading Coil Status [01h]>

Reads out the coil status (ON/OFF).

(Example)

Read multi-function inputs S1 to S6 on the Inverter with slave address 8.

4-2 Function Mode

Refer to the following table for the multi-function input terminal statuses.

Multi-function input terminals	S1	S2	S3	S4	S5	S6
Coil No.	7	8	9	10	11	12
Terminal status	ON	ON	ON	OFF	ON	OFF

Coils 13 and 14 are OFF.

Query			Response		
No.	Field name	Example (HEX)	No.	Field name	Example (HEX)
1	Slave address ^{*1}	08	1	Slave address	08
2	Function code	01	2	Function code	01
3	Coil start number (MSB)	00	3	Number of data bytes	01
4	Coil start number (LSB)	07	4	Coil data ^{*3}	17
5	Number of coils (MSB) ^{*2}	00	5	CRC-16 (MSB)	12
6	Number of coils (LSB) ^{*2}	06	6	CRC-16 (LSB)	1A
7	CRC-16 (MSB)	0D			
8	CRC-16 (LSB)	50			

*1. Broadcasting cannot be performed.

*2. When specifying the value for 0 or over 32 of the reading coils, the error code "03h" is replied.

*3. Data is transferred by the number of data bytes.

*4. Note that the coil start number is "0006", which is smaller by 1 than the coil number "007h".

The data received as the response shows the statuses of coils 7 to 14. The data received here, "P7h = 00010111b", should be read with coil 7 as LSB, as follows:

Coil No.	14	13	12	11	10	9	8	7
Coil status	OFF	OFF	OFF	ON	OFF	ON	ON	ON

If the reading coil exceeds the defined coil range in the final coil data, such coil data is regarded as "0" and sent.

Refer to "<Exception Response>" (page 4-76) if the coil status reading command has not been performed normally.

<Reading the Holding Register Content [03h]>

Reads the specified number of consecutive holding register contents from the specified holding register addresses.

(Example)

- Reads the latest trip information (frequency, current, voltage at trip) from the Inverter with the slave address "1".
- Refer to the trip status as follows:

3G3MX command	D081 (Factor)	D081 (Frequency)	D081 (Output current)	D081 (DC bus V DC)
Register No.	0012h	0014h	0016h	0017h
Trip status	Overcurrent (E03)	9.9 Hz	3.0 A	284 V

Query			Response		
No.	Field name	Example (Hex)	No.	Field name	Example (Hex)
1	Slave address*1	01	1	Slave address	01
2	Function code	03	2	Function code	03
3	Register start address (MSB)*3	00	3	Number of data bytes*2	0C
4	Register start address (LSB)*3	11	4	Register data 1 (MSB)	00
5	Number of holding registers (MSB)	00	5	Register data 1 (LSB)	03
6	Number of holding registers (LSB)	06	6	Register data 2 (MSB)	00
7	CRC-16 (MSB)	95	7	Register data 2 (LSB)	00
8	CRC-16 (LSB)	CD	8	Register data 3 (MSB)	00
			9	Register data 3 (LSB)	63
			10	Register data 4 (MSB)	00
			11	Register data 4 (LSB)	00
			12	Register data 5 (MSB)	00
			13	Register data 5 (LSB)	1E
			14	Register data 6 (MSB)	01
			15	Register data 6 (LSB)	1C
			16	CRC-16 (MSB)	AF
			17	CRC-16 (LSB)	6D

*1. Broadcasting cannot be performed.

*2. Data is transferred by the number of data bytes. In this example, 12 ("0Ch") bytes are used since 6 pieces of holding register data are returned.

*3. Note that the holding register start address is "0011h", which is smaller by 1 than the register number "0012h".

Read the data received in the response, as follows:

Response buffer	4-5		6-7		8-9	
Holding register start number	12+0 (MSB)	12+0 (LSB)	12+1 (MSB)	12+1 (LSB)	12+2 (MSB)	12+2 (LSB)
Response data	003h		00h	00h	0063h	
Trip data	Trip factor (E03)		Not used		Frequency (9.9 Hz)	
Response buffer	10-11		12-13		14-15	
Holding register start number	12+3 (MSB)	12+3 (LSB)	12+4 (MSB)	12+4 (LSB)	12+5 (MSB)	12+5 (LSB)
Response data	00h	00h	001Eh		001Ch	
Trip data	Not used		Output current (3.0 A)		DC bus V DC (284V)	

Refer to "<Exception Response>" (4-76) if the holding register content reading command has not been performed normally.

<Writing Into the Coil [05h]>

Writes into one coil.

The following table shows the coil status change.

	Coil status	
	OFF → ON	ON → OFF
Change data (MSB)	FFh	00h
Change data (LSB)	00h	00h

(Example)

Issue the RUN command to the Inverter with slave address 10.

For running, "03" must be set to A002. The coil number of the RUN command is "0001h".

Query			Response		
No.	Field name	Example (HEX)	No.	Field name	Example (HEX)
1	Slave address *	0A	1	Slave address	0A
2	Function code	05	2	Function code	05
3	Coil start number (MSB)	00	3	Coil start number (MSB)	00
4	Coil start number (LSB)	00	4	Coil start number (LSB)	00
5	Change data (MSB)	FF	5	Change data (MSB)	FF
6	Change data (LSB)	00	6	Change data (LSB)	00
7	CRC-16 (MSB)	8D	7	CRC-16 (MSB)	8D
8	CRC-16 (LSB)	41	8	CRC-16 (LSB)	41

* There is no response for broadcasting.

* Note that the coil start number is "0000h", which is smaller by 1 than the coil number "0001h".

Refer to "<Exception Response>" (page 4-76) if writing into the coil cannot be performed normally.

<Writing Into the Holding Register [06h]>

Writes data into the specified holding register.

(Example)

Write 50 Hz into the Inverter with slave address 5 as multi-step speed reference 0 (A020).

The data resolution of the holding register "1029h" of multi-step speed reference 0 (A020) is 0.1 Hz.

To set 50 Hz, set the change data to "500 (1F4h)".

Query			Response		
No.	Field name	Example (HEX)	No.	Field name	Example (HEX)
1	Slave address *	05	1	Slave address	05
2	Function code	06	2	Function code	06
3	Register start number (MSB)	10	3	Register start number (MSB)	10
4	Register start number (LSB)	28	4	Register start number (LSB)	28
5	Change data (MSB)	01	5	Change data (MSB)	01
6	Change data (LSB)	F4	6	Change data (LSB)	F4
7	CRC-16 (MSB)	0C	7	CRC-16 (MSB)	0C
8	CRC-16 (LSB)	91	8	CRC-16 (LSB)	91

* There is no response for broadcasting.

* Note that the holding register start address is "1028h", which is smaller by 1 than the register number "1029h".

Refer to "<Exception Response>" (page 4-76) if writing into the holding register cannot be performed normally.

<Loopback Test [08h]>

Used to check the communications between master and slave. A random value can be used for test data.

(Example)

Loopback test to the Inverter with slave address 1

Query			Response		
No.	Field name	Example (HEX)	No.	Field name	Example (HEX)
1	Slave address *	01	1	Slave address	01
2	Function code	08	2	Function code	08
3	Diagnostic sub code (MSB)	00	3	Diagnostic sub code (MSB)	00
4	Diagnostic sub code (LSB)	00	4	Diagnostic sub code (LSB)	00
5	Data (MSB)	Random	5	Data (MSB)	Random
6	Data (LSB)	Random	6	Data (LSB)	Random
7	CRC-16 (MSB)	CRC	7	CRC-16 (MSB)	CRC
8	CRC-16 (LSB)	CRC	8	CRC-16 (LSB)	CRC

* Broadcasting cannot be performed.

The diagnostic sub code corresponds only with the query data echo (00h, 00h), not any other command.

<Writing Into Multiple Coils [0Fh]>

Rewrites consecutive multiple coils.

(Example)

Change the status of multi-function inputs S1 to S6 on the Inverter with slave address 5. Set the multi-function input terminals as shown in the following table.

Multi-function input terminals	S1	S2	S3	S4	S5	S6
Coil No.	7	8	9	10	11	12
Terminal status	ON	ON	ON	OFF	ON	OFF

Query

No.	Field name	Example (HEX)
1	Slave address ^{*1}	05
2	Function code	0F
3	Coil start number (MSB)	00
4	Coil start number (LSB)	06
5	Number of coils (MSB)	00
6	Number of coils (LSB)	06
7	Number of bytes ^{*2}	02
8	Change data (MSB) ^{*2}	17
9	Change data (LSB) ^{*2}	00
10	CRC-16 (MSB)	DB
11	CRC-16 (LSB)	3E

Response

No.	Field name	Example (HEX)
1	Slave address	05
2	Function code	0F
3	Coil start number (MSB)	00
4	Coil start number (LSB)	06
5	Number of coils (MSB)	00
6	Number of coils (LSB)	06
7	CRC-16 (MSB)	34
8	CRC-16 (LSB)	4C

- *1. There is no response for broadcasting.
- *2. Since the change data comprises both MSB and LSB as a set, make the byte to be an even number by adding 1, even if the byte that actually needs to be changed is an odd number.
- *3. Note that the coil start number is "0006", which is smaller by 1 than the coil number "007h".

Refer to "<Exception Response>" below if writing into multiple coils cannot be performed normally.

<Writing Into Multiple Holding Registers [10h]>

Writes into consecutive multiple holding registers.

(Example)

Set 1st acceleration time 1 (F002) to "3000 sec." for the Inverter with slave address 1.

The data resolution of the holding registers "1014h, 1015h" of acceleration time 1 (F002) is 0.01 seconds. To set 3000 seconds, set change data to "300000 (493E0h)".

Query			Response		
No.	Field name	Example (HEX)	No.	Field name	Example (HEX)
1	Slave address *1	01	1	Slave address	01
2	Function code	10	2	Function code	10
3	Start address (MSB)	10	3	Start address (MSB)	10
4	Start address (LSB)	13	4	Start address (LSB)	13
5	Number of holding registers (MSB)	00	5	Number of holding registers (MSB)	00
6	Number of holding registers (LSB)	02	6	Number of holding registers (LSB)	02
7	Number of bytes *2	02	7	CRC-16 (MSB)	B4
8	Change data 1 (MSB)	00	8	CRC-16 (LSB)	CD
9	Change data 1 (LSB)	04			
10	Change data 2 (MSB)	93			
11	Change data 2 (LSB)	E0			
12	CRC-16 (MSB)	DB			
13	CRC-16 (LSB)	CF			

*1. There is no response for broadcasting.

*2. Specify the number of bytes to be changed, not the number of holding registers.

*3. Note that the holding register start address is "1013h", which is smaller by 1 than the holding address number "1014h".

Refer to "<Exception Response>" below if writing into the multiple holding register cannot be performed normally.

<Exception Response>

The master requires a response for a query except for broadcasting. Though the Inverter should return a response corresponding with the query, it returns an exception response if the query has an error.

The exception response has the field configuration shown in the following table.

Field Configuration
Slave address
Function code
Exception code
CRC-16

The detailed field configuration is shown below. The function code of the exception response is the value of the query function code to which 80h is added. The exception code shows the cause of exception response.

Function code		Exception code	
Query	Exception response	Code	Description
01h	11h	01h	Has specified an unsupported function.
03h	13h	02h	Specified address does not exist.
05h	15h	03h	Specified data has an unacceptable format.
06h	16h	21h	Data is out of the Inverter's range for writing into the holding register.
0Fh	1Fh	22h	The Inverter does not allow this function.
10h	90h		<ul style="list-style-type: none"> • Has attempted to change the register that cannot be changed during operation. • Has issued the enter command during operation (UV). • Has written into the register during trip (UV). • Has written into the read-only register (coil).

■ To Save the Change to the Holding Register (Enter Command)

Even if using the command to write into the holding register (06h) or into the consecutive holding registers (10h), no change can be saved in the Inverter's memory element. If the Inverter power shuts off without saving any changes, the holding register returns to the status before the changes were made. To save the holding register changes in the Inverter's memory element, the "Enter Command" must be issued according to the following procedure.

To issue the Enter command:

Write into all memory write (holding register number 0900h) using the writing command into the holding register (06h). In this case, a random value can be written into the holding register.

Notes

- The Enter command needs considerable time. Monitor the data writing signal (coil number 001Ah) to check whether the data is being written.
- Since the Inverter's memory element has a limit on the number of rewrites (approx. 100,000 times), the Inverter life may be shortened if enter commands are frequently used.

■ Register Number List

R/W in the list shows whether the coil or holding register accepts reading and/or writing.

R: Read only R/W: Read and write enabled

Coil Number List

Coil No.	Function name	R/W	Description
0000h	No used	—	
0001h	RUN command	R/W	1: RUN 0: Stop (Enabled when A002 = 03)
0002h	Rotation direction command	R/W	1: Reverse 0: Forward (Enabled when A002 = 03)
0003h	External trip (EXT)	R/W	1: Trip
0004h	Trip reset (RS)	R/W	1: Reset
0005h	No used	—	
0006h	No used	—	
0007h	Multi-function input 1	R/W	1: ON 0: OFF *1
0008h	Multi-function input 2	R/W	1: ON 0: OFF *1
0009h	Multi-function input 3	R/W	1: ON 0: OFF *1
000Ah	Multi-function input 4	R/W	1: ON 0: OFF *1
000Bh	Multi-function input 5	R/W	1: ON 0: OFF *1
000Ch	Multi-function input 6	R/W	1: ON 0: OFF *1
000Dh	Not used	—	
000Eh	Operation status	R	1: RUN 0: Stop (Interlocked with d003)
000Fh	Rotation direction	R	1: Reverse 0: Forward (Interlocked with d003)
0010h	Inverter ready	R	1: Ready 0: Not ready
0011h to 0013h	Not used	—	
0014h	Alarm signal	R	1: During trip 0: Normal
0015h	Excessive PID deviation signal	R	1: ON 0: OFF

*1. When either the control circuit terminal block or the coil is turned ON, these settings are ON.

The control circuit terminal block has the priority for the multi-function input terminals.

If the master cannot reset the coil ON status because of communication disconnection, turn the control circuit terminal block from ON to OFF in order to turn off the coil.

*2. The content of a communications error is retained until a fault reset is input. (Can be reset during operation.)

4-2 Function Mode

Coil No.	Function name	R/W	Description
0016h	Overload warning signal	R	1: ON 0: OFF
0017h	Frequency arrival signal (Over set frequency)	R	1: ON 0: OFF
0018h	Frequency arrival signal (At a constant speed)	R	1: ON 0: OFF
0019h	Signal during RUN	R	1: ON 0: OFF
001Ah	Data writing	R	1: Writing 0: Normal
001Bh	CRC error	R	1: Error 0: No error *2
001Ch	Overrun error	R	1: Error 0: No error *2
001Dh	Framing error	R	1: Error 0: No error *2
001Eh	Parity error	R	1: Error 0: No error *2
001Fh	Check sum error	R	1: Error 0: No error *2

*1. When either the control circuit terminal block or the coil is turned ON, these settings are ON.

The control circuit terminal block has the priority for the multi-function input terminals.

If the master cannot reset the coil ON status because of communication disconnection, turn the control circuit terminal block from ON to OFF in order to turn off the coil.

*2. The content of a communications error is retained until a fault reset is input. (Can be reset during operation.)

Holding Register Number List

Register No.	Function name	Parameter No.	R/W function	Monitor or data range	Resolution
0002h	Frequency reference (Enable when A001 = 03)	—	R/W	0 to 4000	0.1 [Hz]
0003h	Inverter status	—	R	00: Default 01: (Reserved) 02: Stop 03: Run 04: Free-run stop (FRS) 05: Jogging 06: DC injection braking 07: Retry 08: Trip 09: Undervoltage	—
0005h	PID feedback (Enable when A076 = 02)	—	R/W	0 to 1000	0.1 [%]
1002h	Output frequency monitor	d001	R	0 to 4000	0.1 [Hz]
1003h	Output current monitor	d002	R	0 to 2000	0.1 [%]
1004h	Rotation direction monitor	d003	R	00: Stop 01: Forward 02: Reverse	

Register No.	Function name	Parameter No.	R/W function	Monitor or data range	Resolution
1005h	PID feedback value monitor (A075 PID scale)	d004 (MSB)	R	0 to 999900	0.01 [%]
1006h		d004 (LSB)			
1007h	Multi-function input monitor	d005	R	0 to 127 Multi-function input status, Bit 0 = [1] to Bit 5 = [6]	—
1008h	Multi-function output monitor	d006	R	0 to 7 Multi-function output status, Bit 0 = [P1] Bit 1 = [P2] Bit 2 = [MA]	—
1009h	Output frequency monitor (after conversion)	d007 (MSB)	R	0 to 3996000	0.01
100Ah		d007 (LSB)			
100Ch	Output voltage monitor	d013	R	0 to 20000	0.01 [%]
100Eh	Total RUN time	d016 (MSB)	R	0 to 999999	1 [h]
100Fh		d016 (LSB)			
1010h	Power ON time monitor	d017 (MSB)	R	0 to 999999	1 [h]
1011h		d017 (LSB)			
0011h	Fault frequency monitor	d080	R	0 to 65535	—
0012h	Fault monitor 1	d081	R	Trip monitor 1: Factor code	—
0014h			R	Trip monitor 1: Frequency	0.1 [Hz]
0016h			R	Trip monitor 1: Current	0.1 [A]
0017h			R	Trip monitor 1: Voltage	1. [V]
0018h			R	Trip monitor 1: Run time (MSB)	1. [h]
0019h			R	Trip monitor 1: Run time (LSB)	
001Ah			R	Trip monitor 1: ON time (MSB)	1. [h]
001Bh			R	Trip monitor 1: ON time (LSB)	
001Ch	Fault monitor 2	d082	R	Trip monitor 2: Factor code	—
001Eh			R	Trip monitor 2: Frequency	0.1 [Hz]
0020h			R	Trip monitor 2: Current	0.1 [A]
0021h			R	Trip monitor 2: Voltage	1. [V]
0022h			R	Trip monitor 2: Run time (MSB)	1. [h]
0023h			R	Trip monitor 2: Run time (LSB)	
0024h			R	Trip monitor 2: ON time (MSB)	1. [h]
0025h			R	Trip monitor 2: ON time (LSB)	

4-2 Function Mode

Register No.	Function name	Parameter No.	R/W function	Monitor or data range	Resolution
0026h	Fault monitor 3	d083	R	Trip monitor 3: Factor code	—
0028h			R	Trip monitor 3: Frequency	0.1 [Hz]
002Ah			R	Trip monitor 3: Current	0.1 [A]
002Bh			R	Trip monitor 3: Voltage	1. [V]
002Ch			R	Trip monitor 3: Run time (MSB)	1. [h]
002Dh			R	Trip monitor 3: Run time (LSB)	
002Eh			R	Trip monitor 3: ON time (MSB)	1. [h]
002Fh			R	Trip monitor 3: ON time (LSB)	
1014h	Acceleration time 1	F002 (MSB)	R/W	1 to 300000 The second decimal place is ignored when the value is over 10000 (100.0 seconds).	0.01 [s]
1015h		F002 (LSB)	R/W		
1501h	2nd acceleration time 1	F202 (MSB)	R/W	1 to 300000 The second decimal place is ignored when the value is over 10000 (100.0 seconds).	0.01 [s]
1502h		F202 (LSB)	R/W		
1016h	Deceleration time 1	F003 (MSB)	R/W	1 to 300000 The second decimal place is ignored when the value is over 10000 (100.0 seconds).	0.01 [s]
1017h		F003 (LSB)	R/W		
1503h	2nd deceleration time 1	F203 (MSB)	R/W	1 to 300000 The second decimal place is ignored when the value is over 10000 (100.0 seconds).	0.01 [s]
1504h		F203 (LSB)	R/W		
1018h	Operator rotation direction selection	F004	R/W	00: Forward 01: Reverse	—
1019h	Frequency reference selection	A001	R/W	00: Digital Operator (volume) 01: Terminal 02: Digital Operator (F001) 03: ModBus communication 10: Frequency operation result	—
101Ah	RUN command selection	A002	R/W	01: Terminal 02: Digital Operator 03: ModBus communication	
101Bh	Base frequency	A003	R/W	30. to maximum frequency A004	1. [Hz]
150Ch	2nd base frequency	A203	R/W	30. to maximum frequency A204	1. [Hz]
101Ch	Maximum frequency	A004	R/W	30 to 400	1. [Hz]
150Dh	2nd maximum frequency	A204	R/W	30 to 400	1. [Hz]

Register No.	Function name	Parameter No.	R/W function	Monitor or data range	Resolution
101Dh	FV/FI selection	A005	R/W	00: Switches between FV/FI via terminal AT 01: Disabled (Outputs FV+FI) 02: Switches between FV/FREQ adjuster via terminal AT 03: Switches between FI/FREQ adjuster via terminal AT	—
1020h	FV start frequency	A011	R/W	0 to 4000	0.1 [Hz]
1022h	FV end frequency	A012	R/W	0 to 4000	0.1 [Hz]
1023h	FV start ratio	A013	R/W	0 to 100	1 [%]
1024h	FV end ratio	A014	R/W	0 to 100	1 [%]
1025h	FV start selection	A015	R/W	00: Start frequency A011 01: 0 Hz	—
1026h	FV, FI sampling	A016	R/W	1 to 17	—
1029h	Multi-step speed reference 0	A020	R/W	0.0/Starting frequency to 4000	0.1 [Hz]
150Fh	2nd multi-step speed reference 0	A220	R/W	0.0/Starting frequency to 4000	0.1 [Hz]
102Bh	Multi-step speed reference 1	A021	R/W	0.0/Starting frequency to 4000	0.1 [Hz]
102Dh	Multi-step speed reference 2	A022	R/W		
102Fh	Multi-step speed reference 3	A023	R/W		
1031h	Multi-step speed reference 4	A024	R/W		
1033h	Multi-step speed reference 5	A025	R/W		
1035h	Multi-step speed reference 6	A026	R/W		
1037h	Multi-step speed reference 7	A027	R/W		
1039h	Multi-step speed reference 8	A028	R/W		
103Bh	Multi-step speed reference 9	A029	R/W		
103Dh	Multi-step speed reference 10	A030	R/W		
103Fh	Multi-step speed reference 11	A031	R/W		
1041h	Multi-step speed reference 12	A032	R/W		
1043h	Multi-step speed reference 13	A033	R/W		
1045h	Multi-step speed reference 14	A034	R/W		
1047h	Multi-step speed reference 15	A035	R/W		
1048h	Jogging frequency	A038	R/W	0 to 999	0.01 [Hz]
1049h	Jogging stop selection	A039	R/W	00: Free-run stop 01: Deceleration stop 02: DC injection braking stop	—

4-2 Function Mode

Register No.	Function name	Parameter No.	R/W function	Monitor or data range	Resolution
104Bh	Manual torque boost voltage	A042	R/W	0 to 200	0.1 [%]
1511h	2nd manual torque boost voltage	A242	R/W		
104Ch	Manual torque boost frequency	A043	R/W	0 to 500	0.1 [%]
1512h	2nd manual torque boost frequency	A243	R/W		
104Dh	V/f characteristics selection	A044	R/W	00: Constant torque characteristics (VC) 01: Special reduced torque characteristics (Special VP) 02: Intelligent sensor-less vector control (iSLV)	—
1513h	2nd V/f characteristics selection	A244	R/W		
104Eh	Output voltage gain	A045	R/W	20 to 100	1. [%]
1514h	2nd output voltage gain	A245	R/W		
104Fh	Automatic torque boost voltage compensation gain	A046	R/W	0 to 255	1. [%]
1515h	2nd automatic torque boost voltage compensation gain	A246	R/W		
1050h	Automatic torque boost slip compensation gain	A047	R/W	0 to 255	1. [%]
1516h	2nd automatic torque boost slip compensation gain	A247	R/W		
1051h	DC injection braking selection	A051	R/W	00: Disabled 01: Enabled during stop	—
1052h	DC injection braking frequency	A052	R/W	0 to 600	0.1 [Hz]
1053h	DC injection braking delay time	A053	R/W	0 to 50	0.1 [s]
1054h	DC injection braking power	A054	R/W	0 to 100	1. [%]
1055h	DC injection braking time	A055	R/W	0 to 600	0.1 [s]
1056h	DC injection braking method selection	A056	R/W	00: Edge operation 01: Level operation	—
105Ah	Frequency upper limit	A061	R/W	0.0/Frequency lower limit : A062 x 10 to Maximum frequency : A004 x 10	0.1 [Hz]
1517h	2nd frequency upper limit	A261	R/W	0.0/2nd frequency lower limit : A262 x 10 to 2nd max. frequency : A204 x 10	0.1 [Hz]
105Bh	Frequency lower limit	A062	R/W	0.0/Starting frequency : b082 x 10 to Frequency upper limit : A061 x 10	0.1 [Hz]
1518h	2nd frequency lower limit	A262	R/W	0.0/Starting frequency : b082 x 10 to 2nd frequency upper limit : A261x10	0.1 [Hz]

Register No.	Function name	Parameter No.	R/W function	Monitor or data range	Resolution
105Dh 1060h 1063h	Jump frequency 1 Jump frequency 2 Jump frequency 3	A063, A065, A067	R/W	0 to 4000	0.1 [Hz]
105Eh 1061h 1064h	Jump frequency width 1 Jump frequency width 2 Jump frequency width 3	A064, A066, A068	R/W	0 to 100	0.1 [Hz]
1068h	PID selection	A071	R/W	00: Disabled 01: Enabled	—
1069h	PID P gain	A072	R/W	2 to 50	0.1
106Ah	PID I gain	A073	R/W	0 to 1500	0.1 [s]
106Bh	PID D gain	A074	R/W	0 to 1000	0.1 [s]
106Ch	PID scale	A075	R/W	1 to 9999	0.01
106Dh	PID feedback selection	A076	R/W	00: Feedback (FI) 01: Feedback (FV) 02: External communication 10: Operation function output	—
106Eh	Reverse PID function	A077	R/W	00: OFF (Deviation = Target value - Feedback value) 01: ON (Deviation = Feedback value - Target value)	—
106Fh	PID output limit function	A078	R/W	0 to 1000	0.1 [%]
1070h	AVR selection	A081	R/W	00: Always ON 01: Always OFF 02: OFF during deceleration	—
1071h	AVR voltage selection	A082	R/W	200-V class 0: 200 1: 215 2: 220 3: 230 4: 240 400-V class 0: 380 1: 400 2: 415 3: 440 4: 460 5: 480	—
1074h	Acceleration time 2	A092 (MSB)	R/W	1 to 300000 The second decimal place is ignored when the value is over 10000 (100.0 seconds).	0.01 [s]
1075h		A092 (LSB)	R/W		
1519h	2nd acceleration time 2	A292 (MSB)	R/W	1 to 300000 The second decimal place is ignored when the value is over 10000 (100.0 seconds).	0.01 [s]
151Ah		A292 (LSB)	R/W		

4-2 Function Mode

Register No.	Function name	Parameter No.	R/W function	Monitor or data range	Resolution
1076h	Deceleration time 2	A093 (MSB)	R/W	1 to 300000 The second decimal place is ignored when the value is over 10000 (100.0 seconds).	0.01 [s]
1077h		A093 (LSB)	R/W		
151Bh	2nd deceleration time 2	A293 (MSB)	R/W	1 to 300000 The second decimal place is ignored when the value is over 10000 (100.0 seconds).	0.01 [s]
151Ch		A293 (LSB)	R/W		
1078h	2-step acceleration/ deceleration selection	A094	R/W	00: Switched via terminal 2CH 01: Switched by setting	—
151Dh	2nd 2-step acceleration/ deceleration selection	A294	R/W		
107Ah	2-step acceleration frequency	A095	R/W	0 to 4000	0.1 [Hz]
151Fh	2nd 2-step acceleration frequency	A295	R/W		
107Ch	2-step deceleration frequency	A096	R/W	0 to 4000	0.1 [Hz]
1521h	*2nd 2-step deceleration frequency	A296	R/W		
107Dh	Acceleration pattern selection	A097	R/W	00: Line 01: S-shape curve	—
107Eh	Deceleration pattern selection	A098	R/W	00: Line 01: S-shape curve	—
1080h	FI start frequency	A101	R/W	0 to 4000	0.1 [Hz]
1082h	FI end frequency	A102	R/W	0 to 4000	0.1 [Hz]
1083h	FI start ratio	A103	R/W	0 to 100	1. [%]
1084h	FI end ratio	A104	R/W	0 to 100	1. [%]
1085h	FI start selection	A105	R/W	00: Start frequency A101 01: 0 Hz	—
108Eh	Operation frequency input A setting	A141	R/W	00: Digital Operator (F001) 01: Digital Operator (volume) 02: Input FV 03: Input FI 04: RS485 communications	—
108Fh	Operation frequency input B setting	A142	R/W		
1090h	Operator selection	A143	R/W	00: Addition (A + B) 01: Subtraction (A - B) 02: Multiplication (A × B)	—
1091h	Frequency addition amount	A145	R/W	0 to 4000	0.1 [Hz]
1093h	Frequency addition direction	A146	R/W	00: Adds the A145 value to the output frequency 01: Subtract A145 value from output frequency	—
1095h	VR start frequency	A151	R/W	0 to 4000	0.1 [Hz]
1097h	VR end frequency	A152	R/W	0 to 4000	0.1 [Hz]

Register No.	Function name	Parameter No.	R/W function	Monitor or data range	Resolution
1098h	VR start ratio	A153	R/W	0 to 100	1. [%]
1099h	VR end ratio	A154	R/W	0 to 100	1. [%]
109Ah	VR start selection	A155	R/W	00: Start frequency A151	-
10A5h	Retry selection	b001	R/W	00: Alarm 01: 0 Hz start 02: Frequency matching restart 03: Trip after frequency matching deceleration stop	—
10A6h	Allowable momentary power interruption time	b002	R/W	3 to 250	0.1 [s]
10A7h	Retry wait time	b003	R/W	3 to 1000	0.1 [s]
10A8h	Momentary power interruption/undervoltage trip during stop selection	b004	R/W	00: Disabled 01: Enabled	—
10A9h	Momentary power interruption retry time selection	b005	R/W	00: 16 times 01: No limit	—
10ADh	Electronic thermal level	b012	R/W	2000 to 12000	0.01 [%]
1527h	2nd electronic thermal level	b212	R/W	Set the rated current to 10000	
10AEh	Electronic thermal characteristics selection	b013	R/W	00: Reduced torque characteristics 1 01: Constant torque characteristics 02: Reduced torque characteristics 2	—
1528h	2nd electronic thermal characteristics selection	b213	R/W		—
10B5h	Overload limit selection	b021	R/W	00: Disabled 01: Enabled in acceleration/constant speed operation	—
1529h	2nd overload limit selection	b221	R/W	02: Enabled in constant speed operation	—
10B6h	Overload limit level	b022	R/W	1000 to 15000	0.01 [%]
152Ah	2nd overload limit level	b222	R/W	Set the rated current to 10000	
10B7h	Overload limit parameter	b023	R/W	1 to 300	0.1 [s]
152Bh	2nd overload limit parameter	b223	R/W		
10BBh	Overload limit source selection	b028	R/W	00: Set values in b022 01: Input FV terminal	—
152Ch	2nd overload limit source selection	b228	R/W	00: Set values in b222 01: Input FV terminal	—

4-2 Function Mode

Register No.	Function name	Parameter No.	R/W function	Monitor or data range	Resolution
10BCh	Soft lock selection	b031	R/W	00: Data other than b031 cannot be changed when terminal SFT is ON. 01: Data other than b031 and the specified frequency parameter cannot be changed when terminal SFT is ON. 02: Data other than b031 cannot be changed. 03: Data other than b031 and the specified frequency parameter cannot be changed. 10: Data other than parameters changeable during operation cannot be changed.	—
10CFh	AM adjustment	b080	R/W	0 to 255	—
10D1h	Starting frequency	b082	R/W	5 to 99	0.1 [Hz]
10D2h	Carrier frequency	b083	R/W	20 to 140	0.1 [kHz]
10D3h	Initialization selection	b084	R/W	00: Clears the trip monitor 01: Initializes data 02: Clears the trip monitor and initializes data	—
10D4h	Initialization parameter selection	b085	R/W	00: Fixed *Do not change.	—
10D5h	Frequency conversion coefficient	b086	R/W	1 to 999	0.1
10D6h	STOP key selection	b087	R/W	00: Enabled 01: Disabled	—
10D7h	Free-run stop selection	b088	R/W	00: 0 Hz start 01: Frequency pull-in restart	—
10D9h	Usage rate of regenerative braking function	b090	R/W	0 to 1000	0.1 [%]
10DAh	Stop selection	b091	R/W	00: Deceleration→Stop 01: Free-run stop	—
10DBh	Cooling fan control	b092	R/W	00: Always ON 01: ON during RUN 02: Depends on the fin temperature	—
10DCh	Regenerative braking function operation selection	b095	R/W	00: Disabled 01: Enabled (disabled during stop) 02: Enabled (also during stop)	—
10DDh	Regenerative braking function ON level	b096	R/W	200-V class: 330 to 395 400-V class: 660 to 790	1. [V]
10F5h	Overvoltage LAD stop function	b130	R/W	00: Disabled 01: Enabled	—
10F6h	Overvoltage LAD stop function level setting	b131	R/W	200-V class: 330 to 395, 400-V class: 660 to 790	1. [V]
10F7h	Overcurrent suppression function	b140	R/W	00: Disabled 01: Enabled	—

Register No.	Function name	Parameter No.	R/W function	Monitor or data range	Resolution
10F8h	Automatic carrier reduction	b150	R/W	00: Disabled 01: Enabled	—
10F9h	Ready function selection	b151	R/W	00: RDY disabled 01: RDY enabled	—
1103h	Multi-function input 1 selection	C001	R/W	00: FW/01: RV/02: CF1/03: CF2/04: CF3/05: CF4/06: JG/07: DB/08: SET/09: 2CH/11: FRS/12: EXT/13: USP/15: SFT/ 16: AT/18: RS/19: PTC terminal 5 only/ 20: STA/21: STP/22: F/R/23: PID/24: PIDC/27: UP/28: DWN/29: UDC/31: OPE/50: ADD/51: F-TM/52: RDY/53: SP-SET/255: NO	—
1532h	2nd multi-function input 1 selection	C201	R/W		
1104h	Multi-function input 2 selection	C002	R/W		
1533h	2nd multi-function input 2 selection	C202	R/W		
1105h	Multi-function input 3 selection	C003	R/W		
1534h	2nd multi-function input 3 selection	C203	R/W		
1106h	Multi-function input 4 selection	C004	R/W		
1535h	2nd multi-function input 4 selection	C204	R/W		
1107h	Multi-function input 5 selection	C005	R/W		
1536h	2nd multi-function input 5 selection	C205	R/W		
1108h	Multi-function input 6 selection	C006	R/W		
1537h	2nd multi-function input 6 selection	C206	R/W		
110Bh	Multi-function input 1 operation selection	C011	R/W	00: NO 01: NC	—
110Ch	Multi-function input 2 operation selection	C012	R/W		
110Dh	Multi-function input 3 operation selection	C013	R/W		
110Eh	Multi-function input 4 operation selection	C014	R/W		
110Fh	Multi-function input 5 operation selection	C015	R/W		
1110h	Multi-function input 6 operation selection	C016	R/W		

4-2 Function Mode

Register No.	Function name	Parameter No.	R/W function	Monitor or data range	Resolution
1114h	Multi-function output terminal P1 selection	C021	R/W	00: RUN/01: FA1/02: FA2/03: OL/04: OD/05: AL/06: Dc/07: FBV/08: NDc/09: LOG	—
1115h	Multi-function output terminal P2 selection	C022	R/W		
1119h	Relay output (MA, MB) function selection	C026	R/W		
111Bh	AM selection	C028	R/W	00: F (Output frequency) 01: A (Output current)	—
111Dh	Multi-function output terminal P1 contact selection	C031	R/W	00: NO contact at MA; NC contact at MB 01: NC contact at MA; NO contact at MB	—
111Eh	Multi-function output terminal P2 contact selection	C032	R/W		—
1122h	Relay output (MA, MB) contact selection	C036	R/W		—
1124h	Overload warning level	C041	R/W	0 to 20000 Set to 10000 at rated current	0.01 [%]
153Ah	2nd overload warning level	C241	R/W		
1126h	Arrival frequency during acceleration	C042	R/W	0 to 4000	0.1 [Hz]
1128h	Arrival frequency during deceleration	C043	R/W	0 to 4000	0.1 [Hz]
1129h	PID deviation excessive level	C044	R/W	0 to 1000	0.1 [%]
112Eh	PID FB upper limit	C052	R/W	0 to 1000	0.1 [%]
112Fh	PID FB lower limit	C053	R/W	0 to 1000	0.1 [%]
1138h	Communication speed selection (Baud rate selection)	C071	—	Do not change through ModBus communication. For setting, refer to page 4-65.	—
1139h	Communication station No. selection	C072	—		
113Bh	Communication parity selection	C074	—		
113Ch	Communication stop bit selection	C075	—		
113Dh	Communication error selection	C076	—		
113Eh	Communication error timeout	C077	—		
113Fh	Communication wait time	C078	—		
1141h	FV adjustment	C081	R/W	0 to 2000	0.1 [%]
1142h	Fl adjustment	C082	R/W	0 to 2000	0.1 [%]
1144h	Thermistor adjustment	C085	R/W	0 to 2000	0.1 [%]
1145h	AM offset adjustment	C086	R/W	0 to 100	0.1 [V]

Register No.	Function name	Parameter No.	R/W function	Monitor or data range	Resolution
—	Not used	C091	—	Do not change.	—
1149h	UP/DWN selection	C101	R/W	00: OFF/01: ON	—
114Ah	Reset selection	C102	R/W	00: Trip reset at power-on 01: Trip reset when the power is OFF 02: Enabled only during trip (Reset when the power is ON.)	—
1150h	Logic operation function A input	C141	R/W	00: RUN/01: FA1/02: FA2/03: OL/04: OD/05: AL/06: Dc/07: FBV/08: NDC	—
1151h	Logic operation function B input	C142	R/W		
1152h	Logic operator selection	C143	R/W	00: AND/01: OR/02: XOR	—
1153h	Output terminal P1 ON delay	C144	R/W	0 to 1000	0.1 [s]
1154h	Output terminal P1 OFF delay	C145	R/W	0 to 1000	
1155h	Output terminal P2 ON delay	C146	R/W	0 to 1000	
1156h	Output terminal P2 OFF delay	C147	R/W	0 to 1000	
1157h	Relay output ON delay	C148	R/W	0 to 1000	
1158h	Relay output OFF delay	C149	R/W	0 to 1000	
1165h	Motor capacity selection	H003	R/W	00: 0.2/02: 0.4/04: 0.75/ 06: 1.5/07: 2.2/09: 3.7/ 11: 5.5/12: 7.5	—
1541h	2nd motor capacity selection	H203	R/W	00: 0.2/02: 0.4/04: 0.75/ 06: 1.5/07: 2.2/09: 3.7/ 11: 5.5/12: 7.5	—
1166h	Motor pole number selection	H004	R/W	2/4/6/8	1 [pole]
1542h	2nd motor pole number selection	H204	R/W	2/4/6/8	1 [pole]
1168h	Stabilization parameter	H006	R/W	0. to 255.	1. [%]
1544h	2nd stabilization parameter	H206	R/W	0. to 255.	1. [%]
1169h	Motor voltage selection	H007	R/W	00: 200 V 01: 400 V	—
1545h	2nd motor voltage selection	H207	R/W		
0900h	Enter command	—	W	Indefinite value	—

Chapter 5

Maintenance Operations

5-1	Special Display List	5-1
5-2	Troubleshooting.....	5-5

5-1 Special Display List

Error Code List

Name	Description	Display on Digital Operator
Overcurrent trip	If the motor is restrained or rapidly accelerated or decelerated, a large current flows through the Inverter, which may result in breakage. To avoid this, an overcurrent protection circuit works to shut off the Inverter output.	Constant speed E 01
		Deceleration E 02
		Acceleration E 03
		Others E 04
Overload trip *1	If an Inverter output current is detected and the motor is overloaded, an electronic thermal inside the Inverter works to shut off the Inverter output.	E 05
Braking resistor overload trip	If the usage rate of the braking resistor is exceeded, this function detects overvoltage through the operation stop of the control circuit and shuts off the Inverter output.	E 06
Overvoltage trip	If the incoming voltage and regenerative energy from the motor are too high, a protection circuit works to shut off the Inverter output when the voltage on the converter exceeds the specified level.	E 07
EEPROM error *2 *3	Shuts off the output if an error occurs in the EEPROM built into the Inverter due to external noise and abnormal temperature rise.	E 08
Undervoltage trip	Shuts off the output if the incoming voltage drops below the specified level, causing the control circuit not to work properly during a momentary power interruption.	E 09
CPU error*6	Shuts off the output if the internal CPU has worked erroneously or abnormally.	E 11
		E 22
External trip	If an error occurs in the external equipment or devices, the Inverter receives the signal, and the output is shut off. (Available with the external trip function selected)	E 12
USP trip *4	Appears if the Inverter is turned on with the RUN command being input. (Available with the USP function selected)	E 13
Ground fault trip *5	Shuts off the output if a ground fault between the Inverter output unit and the motor is detected when turning on the power.	E 14
Incoming overvoltage trip	Appears if the incoming voltage has remained high for 100 seconds while the Inverter output is stopped.	E 15

Name	Description	Display on Digital Operator
Temperature error	Shuts off the output if the temperature has risen in the main circuit due to malfunction of the cooling fan or other reasons.	E 21
Gate array error	Appears if a fault is detected in communication behavior between the built-in CPU and the gate array.	E 23
Thermistor error (Available when the thermistor trip function is used)	Detects the resistance of the external thermistor and shuts off the Inverter output.	E 35

- *1. After a trip occurs, normal operation is restored in 10 seconds by resetting.
- *2. Check the set data again if the EEPROM error E 08 occurs.
- *3. If the power is shut off during data initialization, an EEPROM error E 08 may occur when the power is next turned on. Shut off the power after completing data initialization or copying.
- *4. If an undervoltage trip E 09 occurs with the USP terminal turned ON, a USP error E 13 occurs after a trip reset. Reset again to release the trip.
- *5. The ground fault trip E 14 cannot be released with the reset input. Shut off the power and check the wiring.
- *6. If the multi-function output (relay output) is set to 05 (alarm), the signal may not be output during the CPU error E 22 . In this case, no error data is stored in the trip monitor.

Other Displays

Name	Description	Display on Digital Operator
Reset	Appears with the [RS] terminal turned ON or during initialization.	
Undervoltage standby	Appears in undervoltage standby condition or with the power shut off.	
Restart during momentary power interruption Restart during trip	Restart function is in operation.	
Setting initialization	Appears while the set values are being initialized.	
Trip monitor initialization	Appears while the trip monitor is being initialized.	
No data	Appears if no data exists. (Trip monitor)	
Communications error	Appears if an error occurs between the Digital Operator and the Inverter.	

Trip Monitor Display

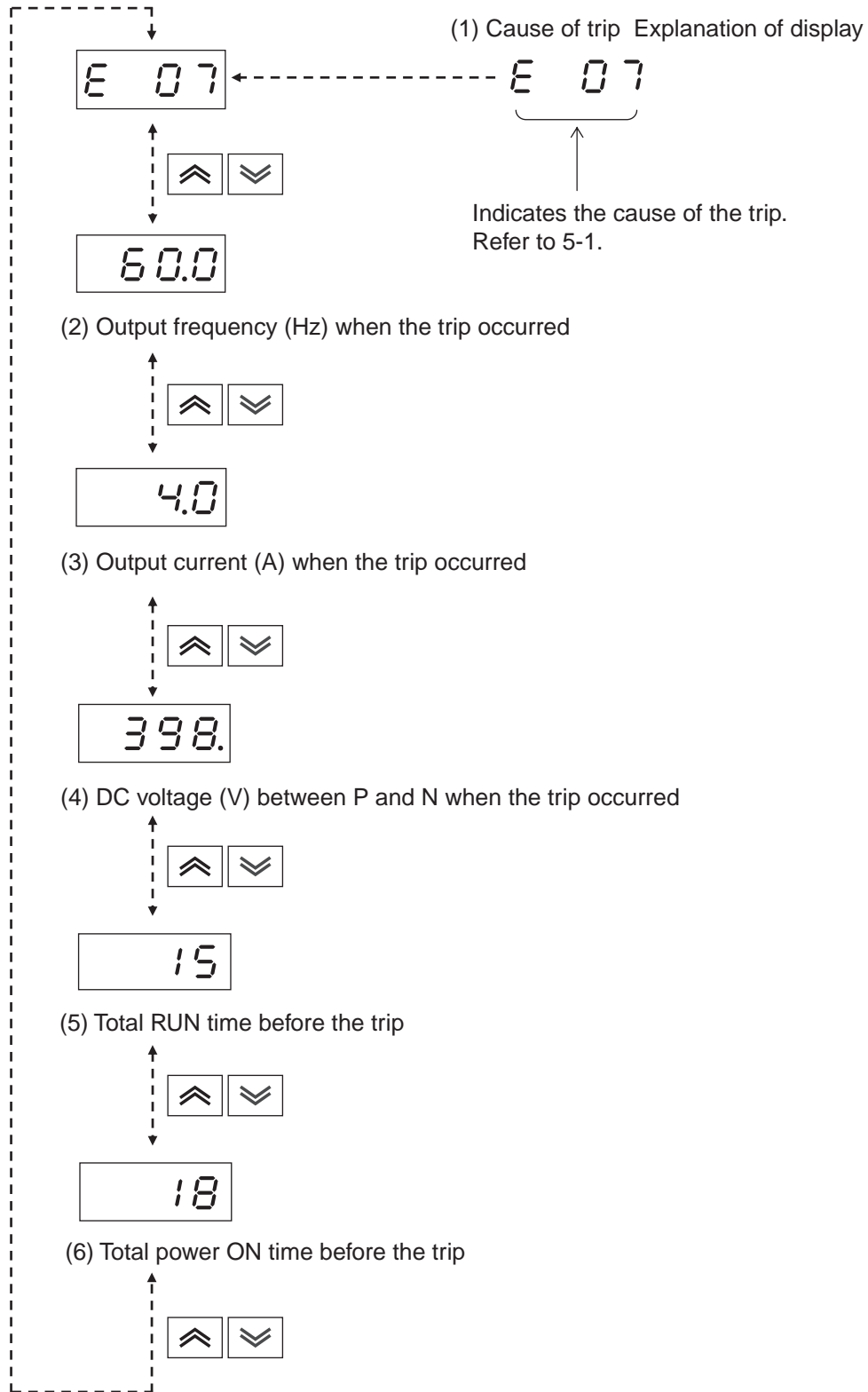

5-2 Troubleshooting

Situation		Possible cause	Remedy
The motor doesn't work.	No voltage observed for Inverter outputs U/T1, V/T2, and W/T3.	<ul style="list-style-type: none"> Is the A001 setting (frequency reference selection) correct? Is the A002 setting (RUN command selection) correct? 	<ul style="list-style-type: none"> Check the A001 setting. Check the A002 setting.
		<ul style="list-style-type: none"> Is the [485/OPE] communications selector status correct? Is the [TM/PRG] selector status correct? 	<ul style="list-style-type: none"> Check the [485/OPE] communications selector. Check the [TM/PRG] selector.
		<ul style="list-style-type: none"> Is power supplied to terminals R/L1, S/L2, and T/L3? If so, the POWER LED indicator should light up. 	<ul style="list-style-type: none"> Check the connections of terminals R/L1, S/L2, T/L3 and U/T1, V/T2, W/T3. Turn on the power.
		<ul style="list-style-type: none"> Does the display show "E ***"? 	<ul style="list-style-type: none"> Press the Mode key to check the situation, and then reset.
		<ul style="list-style-type: none"> Is the allocation of the multi-function input correct? Is the RUN key (RUN command) turned on? Are FW (or RV) input and terminal SC or PSC connected? Is the [SK/SR] selector status correct? 	<ul style="list-style-type: none"> Check the terminal allocation: C001 to C006 Turn on the RUN key (RUN command). Connect FW (or RV) input to terminal SC or PSC. Check the [SK/SR] selector.
		<ul style="list-style-type: none"> Is the frequency set with F001 selected? Is the potentiometer connected to terminals FS/FV/FC? 	<ul style="list-style-type: none"> Press the key to set. If terminal mode is selected, set the potentiometer to FS/FV/FC.
		<ul style="list-style-type: none"> Are RS and FRS inputs still turned on? 	<ul style="list-style-type: none"> Turn off these inputs.
Voltage observed for Inverter outputs U/T1, V/T2, and W/T3.	<ul style="list-style-type: none"> Is the motor restrained? Or is it overloaded? 	<ul style="list-style-type: none"> Release the restraint and reduce the load. Operate the motor separately. 	
Motor rotation is in reverse.	<ul style="list-style-type: none"> Are output terminals U/T1, V/T2, and W/T3 correct? Is the phase sequence of the motor U/T1, V/T2, W/T3, and is the rotation in forward or reverse? 	<ul style="list-style-type: none"> Connect according to the motor phase sequence. (Generally, U/T1, V/T2, W/T3 in forward) 	
		<ul style="list-style-type: none"> Is the control circuit terminal correct? Is F004 set correctly in the motor rotation direction selection via the Digital Operator? 	<ul style="list-style-type: none"> Select FW for forward and RV for reverse.

Situation		Possible cause	Remedy
Motor rotation speed does not rise.		<ul style="list-style-type: none"> Does not rise even after the frequency setting unit is turned on with correct wiring. 	<ul style="list-style-type: none"> Replace the frequency setting unit.
		<ul style="list-style-type: none"> Is the motor overloaded? 	<ul style="list-style-type: none"> Reduce the load. Motor rpm becomes lower than the set value due to the limit function if overloaded.
Rotation is unstable.		<ul style="list-style-type: none"> Is the load too varied? Is the power voltage varied? Is this situation observed at a specific frequency? 	<ul style="list-style-type: none"> Increase the capacity of both the motor and Inverter. Reduce the variation. Finely adjust the output frequency.
Motor rotation doesn't match.		<ul style="list-style-type: none"> Is the maximum frequency setting correct? 	<ul style="list-style-type: none"> Check the V/F pattern according to the motor specifications. Check the transmission gear ratio.
Data value is abnormal.	Does not change with data set.	<ul style="list-style-type: none"> After changing the data using the Increment/Decrement key, the Enter key was not pressed before the power was turned off. 	<ul style="list-style-type: none"> Input data again and press the Enter key.
		<ul style="list-style-type: none"> Was the power turned off within 6 seconds of changing the data and pressing the Enter key? 	<ul style="list-style-type: none"> Wait 6 seconds or more after changing data and pressing the Enter key.
Data would not change.	<ul style="list-style-type: none"> Frequency would not change. Can neither operate nor stop. 	<ul style="list-style-type: none"> Is the selection between operator and terminal modes correct? Is the [485/OPE] communications selector status correct? Is the [TM/PRG] selector status correct? 	<ul style="list-style-type: none"> Check the selections of the setting modes of A001 and A002. Check the [485/OPE] communications selector. Check the [TM/PRG] selector.
	Cannot change data.	<ul style="list-style-type: none"> Is the soft lock activated? Is the soft lock (data: 02 and 03) set in soft lock selection b031? Is it tripped? 	<ul style="list-style-type: none"> Reset the SFT terminal. Set b031 to 00 or 01. Turn off the switch. Reset the trip.

Notes on Data Setting:

Wait 6 seconds or more after changing data and pressing the Enter key to store it.

The data may not be set correctly if you operate any key, perform the reset, or disconnect the power supply within 6 seconds after the data entry.



Chapter 6

Inspection and Maintenance



6-1	Inspection and Maintenance	6-1
6-2	Storage.....	6-7

6-1 Inspection and Maintenance

WARNING

	Do not put on or take off the Digital Operator control circuit terminal block terminal block cover while the input power is being supplied. Doing so may result in a serious injury due to an electric shock.
	Do not remove the terminal block cover during the power supply and 5 minutes after the power shutoff. Doing so may result in a serious injury due to an electric shock.
	Do not change wiring, mode change switches, optional devices or replace cooling fans while power is being supplied. Doing so may result in a serious injury due to an electric shock.

CAUTION

	Do not touch the Inverter fins, braking resistors and the motor, which become too hot during the power supply and for some time after the power shutoff. Doing so may result in a burn.
	Do not dismantle, repair or modify this product. Doing so may result in an injury.

Safety Information

■ Maintenance and Inspection

- Be sure to confirm safety before conducting maintenance, inspection or parts replacement.

Precautions for Use

■ Operation Stop Command

- Provide a separate emergency stop switch because the STOP key on the Digital Operator is valid only when function settings are performed.
- When checking a signal during the power supply and the voltage is erroneously applied to the control input terminals, the motor may start abruptly. Be sure to confirm safety before checking a signal.

■ Product Disposal

- Comply with the local ordinance and regulations when disposing of the product.

General Precautions

- Always keep the Inverter and area clean to prevent dust from entering.
- Take utmost care not to have the wires disconnected or connected wrongly. Tightly fix the terminals and connectors.
- Do not expose the electronic device to humidity, oil, dust and/or iron powder or shavings. Doing so may result in an accident.
- Do not pull on the cables in connecting/disconnecting the connectors (cooling fan and control PCB cables). Doing so may result in fire or injury due to cable damage.

Inspection Item

- Daily inspection
- Periodic inspection (about every year)
- Insulation resistance test (about every two years)

• Insulation resistance test

Short-circuit the terminals as below to conduct the test.

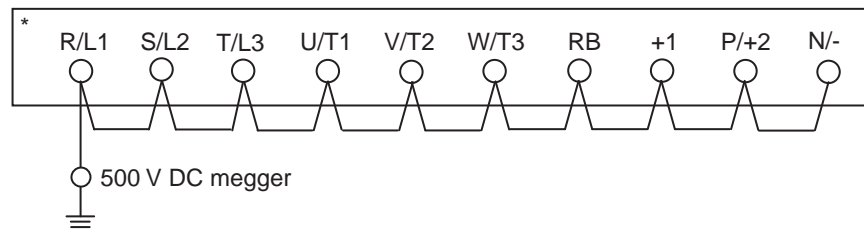

* Terminal symbols for 3G3MX-AE□□□ are indicated as L1, L2, N/L3 instead of R/L1, S/L2, T/L3 respectively.

- Make sure that the resistance between the main circuit terminal and ground is 5 M Ω or more at 500 V DC megger.
- Do not conduct a withstand voltage test on any part of the Inverter. Doing so may result in the deterioration of parts.

* To shorten non-operation time, we recommend always keeping a spare Inverter ready.

■Daily Inspection and Periodic Inspection

Inspection part	Inspection item	Inspection point	Inspection period		Inspection method	Criteria	Standard replacement period	Meter
			Daily	Periodic				
General	Ambient environment	Check ambient temperature, as well as checking for humidity, dust, hazardous gases, oil mist, etc.	✓		Monitoring, visual inspection	Ambient temperature -10°C to +40°C With no freezing Ambient humidity 20% to 90% With no condensation	—	Thermometer Hygrometer
	Entire device	Check that there are no abnormal vibrations or sounds.	✓		Visual or acoustic inspection			
	Power supply voltage	Check that the main circuit voltage is normal.	✓		Voltage measurement between terminals R/L1, S/L2 and T/L3 on the Inverter terminal block.	The following conditions must be satisfied: (200-V class) 200 to 240 V 50/60 Hz (400-V class) 380 to 480 V 50/60 Hz		Tester

*1. The life of the capacitor depends on ambient temperatures. Refer to "Product Life Curve" (App-17).

*2. Clean the Inverter periodically. Accumulated dust in or on the cooling fan or heat sink can cause the Inverter to overheat.

Inspection part	Inspection item	Inspection point	Inspection period		Inspection method	Criteria	Standard replacement period	Meter
			Daily	Periodic				
Main circuit	General	Insulation resistance test (between main circuit terminal and ground terminal)		✓	Megger check (Refer to 6-2.)	5 MΩ min.	—	500 V DC megger
		Check that the screws are secure.		✓	Tighten securely	Tightening torque (excluding terminal block) •M 3.5: 0.8 N•m •M 4 : 1.2 N•m		
		Check that no part has indications of overheating.		✓	Visual inspection			
	Terminal block	Check that there is no damage.		✓	Visual inspection	No faults		
	Smoothing capacitor	Check that there is no liquid leakage. Check that the safety valve has not come out. Check that there are no bulges.	✓ ✓ ✓		Visual inspection	No faults	*1	
	Relay terminal block	Check that there is no abnormal sound during operation.		✓	Acoustic inspection	No faults	—	
	Resistor	Check that there are no large fissures or discoloration in the resistance insulation.		✓	Visual inspection	No faults	—	Tester
Cooling fan	Check that there are no abnormal vibrations or sounds.	✓		Rotate manually when the power is off.	Smooth rotation	2 to 3 years		
	Check that there is no dirt or dust.*2	✓		Visual inspection				
	Check that the fan is mounted correctly.	✓		Visual inspection				

*1. The life of the capacitor depends on ambient temperatures. Refer to "Product Life Curve" (App-17).

*2. Clean the Inverter periodically. Accumulated dust in or on the cooling fan or heat sink can cause the Inverter to overheat.

6-1 Inspection and Maintenance

Inspection part	Inspection item	Inspection point	Inspection period		Inspection method	Criteria	Standard replacement period	Meter
			Daily	Periodic				
Control circuit	Operation check	Check the balance of output voltage levels between phases in Inverter run.		✓	Measure the phase-to-phase voltage between Inverter output terminals U/T1, V/T2, and W/T3.	Voltage difference between phases 2% max.		Digital multimeter Rectifier Voltmeter
		Check that there are no errors in trip detection and the display circuit throughout the operation of sequence protection.		✓	Simulate the Inverter trip circuit output Ex) Use an external trip etc.	Operates with no faults	—	
	Parts check (including PCB)	General	Check that there are no abnormal odors or discoloration. Check that there is no significant rusting.		✓	Visual inspection	No faults	—
	Capacitor	Check that there is no liquid leakage or deformation.	✓		Visual inspection		*1	—
Display	Digital Operator	Check that the display is clear. Check that there are no missing parts. Check that the LED indicators are lit properly.	✓ ✓ ✓		Visual inspection	Normal operation Display can be read	—	—

*1. The life of the capacitor depends on ambient temperatures. Refer to "Product Life Curve" (App-17).

*2. Clean the Inverter periodically. Accumulated dust in or on the cooling fan or heat sink can cause the Inverter to overheat.

Measurement Methods of I/O Voltage, Current, and Electric Power

Below are general measurement devices for I/O voltage, current, and electric power.
Measure effective values of fundamental wave for voltage, and all effective values for electric power.

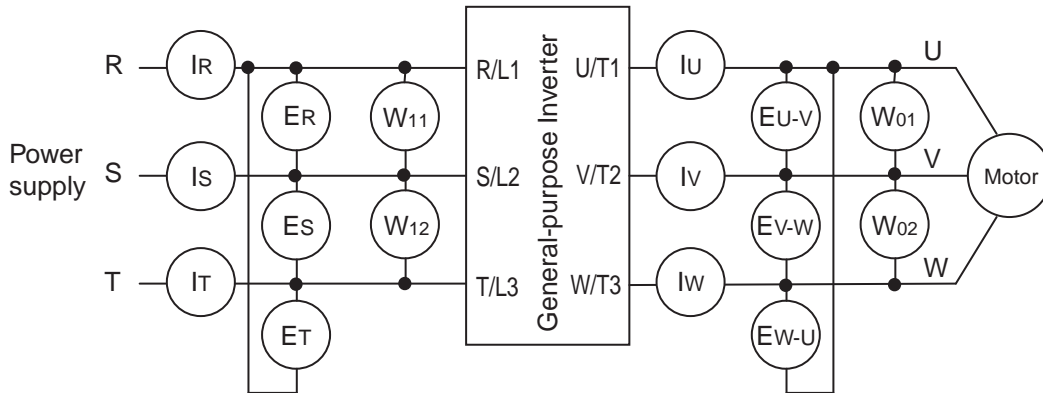

Measurement item	Measurement point	Measurement device	Note	Measurement value reference
Power supply voltage E_i	Phase-to-phase voltage between R-S, S-T, and T-R (ER) (ES) (ET)	Moving-iron voltmeter or Rectifier voltmeter	Effective value of fundamental wave	Commercial current (200-V class) 200 to 240 V, 50/60 Hz (400-V class) 380 to 480 V, 50/60 Hz
Power supply current I_i	Current R, S, T (IR) (IS) (IT)	Moving-iron ammeter	All effective values	
Input electric power W_i	Between R-S, S-T (W11) + (W12)	Electrodynamic wattmeter	All effective values	Two-wattmeter method
Input power factor Pf_i	Calculated from the measured values of power supply voltage E_i , power supply current I_i , and input electric power W_i . $Pf_i = \frac{W_i}{\sqrt{3} \cdot E_i \cdot I_i} \times 100 (\%)$			
Output voltage E_o	Between U-V, V-W, W-U (EU) (EV) (EW)	Rectifier voltmeter	All effective values	
Output current I_o	Current U, V, W (IU) (IV) (IW)	Moving-iron ammeter	All effective values	
Output power W_o	Between U-V, V-W (W01) + (W02)	Electrodynamic wattmeter	All effective values	Two-wattmeter method
Output power factor Pf_o	Calculated from the measured values of output voltage E_o , output current I_o , and output electric power W_o .			

Note 1: For voltage, use a measurement device that displays effective values of fundamental wave. For current and electric power, use a measurement device that displays all effective values.

Note 2: The Inverter output waveform, under PWM control, may have a margin of error, especially at a low frequency. Therefore, use the above shown measurement devices and methods to ensure accuracy.

Note 3: General-purpose testers are not applicable for measurement in many cases.

6-2 Storage

Ensure the following conditions when storing the Inverter temporarily or for a long term after purchase.

- Ensure the following conditions when storing the Inverter temporarily for transportation.
 - Storage temperature : -10°C to 60°C
 - Humidity : 20% to 90% RH
 - (Without condensation or freezing due to rapid temperature change)
- Do not store this unit in a place with dust, direct sunshine, corrosive gas, or combustible gas.
- The Inverter's smoothing capacitor characteristics will deteriorate if left unused for a long time, even with no power distribution, which will shorten its life.

Chapter 7

Specifications

7-1	Standard Specification List.....	7-1
7-2	Measurement Method of Output Voltage	7-5
7-3	Connection Example.....	7-6
7-4	Dimensional Drawing.....	7-8
7-5	Options.....	7-14

7-1 Standard Specification List

■3-phase 200-V Class

Item		3-phase 200-V class							
Model name (3G3MX-)		A2002	A2004	A2007	A2015	A2022	A2037	A2055	A2075
Applicable motor capacity ^{*1}	kW	0.2	0.4	0.75	1.5	2.2	3.7	5.5	7.5
	HP	1/4	1/2	1	2	3	5	7.5	10
Rated output capacity (kVA)	200 V	0.5	1.0	1.7	2.7	3.8	6.0	8.3	11.0
	240 V	0.6	1.2	2.0	3.3	4.5	7.2	9.9	13.3
Rated input voltage		3-phase (3-wire) 200 to 240 V $\pm 10\%$, 50/60 Hz $\pm 5\%$							
Rated output voltage ^{*2}		3-phase 200 to 240 V AC (according to the incoming voltage)							
Rated output current (A)		1.6	3.0	5.0	8.0	11.0	17.5	24.0	32.0
Weight (kg)		0.7	0.85	0.9	1.8	1.8	1.8	3.5	3.5
Cooling method		Self-cooling			Forced-air-cooling				
Braking torque	At short-time deceleration ^{*3} At capacitor feedback	Approx. 50%			Approx. 20% to 40%			Approx. 20%	
	For mounting discharge resistance	Approx. 150%		Approx. 100%		Approx. 80%			
	Minimum connection resistance (Ω)	100	100	50	50	35	35	17	17

■3-phase 400-V Class

Item		3-phase 400-V class						
Model name (3G3MX-)		A4004	A4007	A4015	A4022	A4037	A4055	A4075
Applicable motor capacity ^{*1}	kW	0.4	0.75	1.5	2.2	3.7	5.5	7.5
	HP	1/2	1	2	3	5	7.5	10
Rated output capacity (kVA)	400 V	1.0	1.7	2.6	3.8	5.9	9.0	11.0
	480 V	1.2	2.0	3.1	4.5	7.1	10.8	13.3
Rated input voltage		3-phase (3-wire) 380 to 480 V $\pm 10\%$, 50/60 Hz $\pm 5\%$						
Rated output voltage ^{*2}		3-phase 380 to 480 V AC (according to the incoming voltage)						
Rated output current (A)		1.5	2.5	3.8	5.5	8.6	13.0	16.0
Weight (kg)		1.3	1.7	1.8	1.8	1.8	3.5	
Cooling method		Self-cooling			Forced-air-cooling			
Braking torque	At short-time deceleration ^{*3} At capacitor feedback	Approx. 50%			Approx. 20% to 40%		Approx. 20%	
	For mounting discharge resistance	Approx. 150%	Approx. 100%		Approx. 80%			
	Minimum connection resistance (Ω)	180	180	180	100	100	70	70

■Single/3-phase 200-V Class

Item		1/3-phase 200-V class					
Model name (3G3MX-)		AE002	AE004	AE007	AE015	AE022	
Applicable motor capacity ^{*1}	kW	0.2	0.4	0.75	1.5	2.2	
	HP	1/4	1/2	1	2	3	
Rated output capacity (kVA)	200 V	0.5	0.9	1.3	2.7	3.8	
	240 V	0.6	1.0	1.6	3.3	4.5	
Rated input voltage		1/3-phase 200 to 240 $\pm 10\%$ 50/60 Hz $\pm 5\%$					
Rated output voltage ^{*2}		3-phase 200 to 240 V (Cannot output voltage higher than incoming voltage.)					
Rated output current (A)		1.6	2.6	4.0	8.0	11.0	
Weight (kg)		0.7	0.85	0.9	1.8	1.8	
Cooling method		Self-cooling			Forced-air-cooling		
Braking torque	At short-time deceleration ^{*3} At capacitor feedback	Approx. 50%			Approx. 20% to 40%		
	For mounting discharge resistance	Approx. 150%			Approx. 100%		Approx. 80%
	Minimum connection resistance (Ω)	100	100	50	50	35	

Common Specifications

Item		Specifications
Enclosure rating ^{*4}		Semi-closed (IP20)
Control	Control Method	Phase-to-phase sinusoidal modulation PWM
	Output frequency range ^{*5}	0.5 to 400 Hz
	Frequency precision ^{*6}	Digital command: ±0.01% of the max. frequency Analog command: ±0.2% of the max. frequency (25°C ± 10°C)
	Frequency setting resolution	Digital setting: 0.1 Hz Analog setting: Max. frequency/1000
	Voltage/Frequency characteristics	V/f characteristics (constant/reduced torque)
	Overload current rating	150% for 1 min
	Acceleration/Deceleration time	0.01 to 3000 s (line, S-shape curve), 2nd acceleration/deceleration setting available
	Starting torque	200% min./1 Hz
	Carrier frequency modification range	2.0 to 14.0 kHz
	DC injection braking	Starts at a frequency lower than that in deceleration via the STOP command, or via an external input. (Level and time settable.)
Protective Functions		Overcurrent, overvoltage, undervoltage, electronic thermal, temperature error, ground-fault overcurrent at power-on status, overload limit, incoming overvoltage, external trip, memory error, CPU error, USP error, internal communication error, BRD error, overvoltage protection during deceleration, overcurrent suppression
Input signal	Digital Operator signal	Frequency settings Setting with the FREQ adjuster and the Increment/Decrement keys on the Digital Operator, variable resistance from 1 to 2 kΩ (2 W), 0 to 10 V DC (input impedance 10 kΩ), 4 to 20 mA (input impedance 250 Ω), communication through an RS-485 port (Modbus communication).
		Forward/Reverse Run/Stop Forward/Stop via the RUN/STOP keys (command selection for Forward or Reverse), Reverse/Stop available at the time of terminal allocation (selectable from 1NO or 1NC), Run/Stop through external communication.
	Multi-function input	FW (forward), RV (reverse), CF1 to CF4 (multi-step speed), RS (reset input), AT (current input selection), USP (USP function), EXT (external trip), OPE (forced OPE mode), STA (3-wire startup), STP (3-wire stop), F/R (3-wire forward/reverse), FRS (free run stop), JG (jogging), 2CH (2-step acceleration/deceleration), DB (external DC injection braking), SET (2nd control function), UP (UP/DWN function accelerated), DWN (UP/DWN function decelerated), PID (PID enabled/disabled), PIDC (PID deviation clear), PTC (thermistor input), UDC (UP/DWN function data clear), SFT (soft lock), ADD (frequency addition), F-TM (forced terminal block), RDY (operation ready), SP-SET (special setting)
Output signal	Multi-function output	RUN (signal during operation), FA1 (frequency arrival signal), FA2 (over set frequency arrival signal), OL (overload warning signal), OD (PID excess deviation signal), AL (alarm output), ODC (communication option disconnected), FBV (PID FB status output), NDc (Network error), LOG (Logic operation output)
	Frequency monitor	Analog meter (0 to 10 V DC, 1 mA max.), Frequency/Current signals are selectable via the analog output terminal.
	Relay output	The relay (SPDT contact) outputs signals corresponding to the multi-function output.

	Item	Specifications
Other functions		AVR function, V/f characteristic selection, line acceleration/deceleration, upper/lower limit, 16-step speeds, starting frequency adjustment, jogging operation, carrier frequency adjustment, PID control, frequency jump, analog gain/bias adjustment, S-shape acceleration/deceleration, electronic thermal level adjustment, retry function, automatic torque boost, trip monitor, soft lock function, frequency conversion display, USP function, 2nd control function, motor rotation speed UP/DWN, fan ON/OFF function
General specifications	Ambient temperature	-10°C to 40°C (Carrier frequency: 5 kHz max.) -10°C to 50°C (Both the carrier frequency and output current need to be reduced) ^{*7}
	Ambient storage temperature	-20°C to 65°C (short-time temperature during transport)
	Humidity	20% to 90% RH
	Vibration	5.9 m/s ² (0.6G), 10 to 55 Hz (Complies with the test method specified in JIS C0040 (1999).)
	Location	At a maximum altitude of 1,000 m; indoors (without corrosive gases or dust)
	Applicable standard	Complies with UL, cUL, CE standards. (Insulation distance)
	Options	Noise filter, AC/DC reactors, regenerative braking unit and resistor, etc.

- *1. The applicable motor is a squirrel-cage induction motor. For using any other type, be sure that the rated current does not exceed that of the Inverter.
- *2. Output voltage decreases according to the level of the power supply voltage.
- *3. The braking torque at the time of capacitor feedback is an average deceleration torque at the shortest deceleration (when it stops from 50 Hz), not a continuous regeneration torque. Also, the average deceleration torque varies depending on the motor loss. The value is reduced in operation at over 50 Hz. Note that no braking resistor is built into the Inverter. If you need a larger regenerative torque, use an optionally available braking resistor.
- *4. Protection method complies with JEM 1030.
- *5. To operate the motor at over 50/60 Hz, contact the motor manufacturer to find out the maximum allowable revolution.
- *6. For the stable control of the motor, the output frequency may exceed the maximum frequency set in A004 (A204) by 2 Hz max.
- *7. Refer to page 4-32.

7-2 Measurement Method of Output Voltage

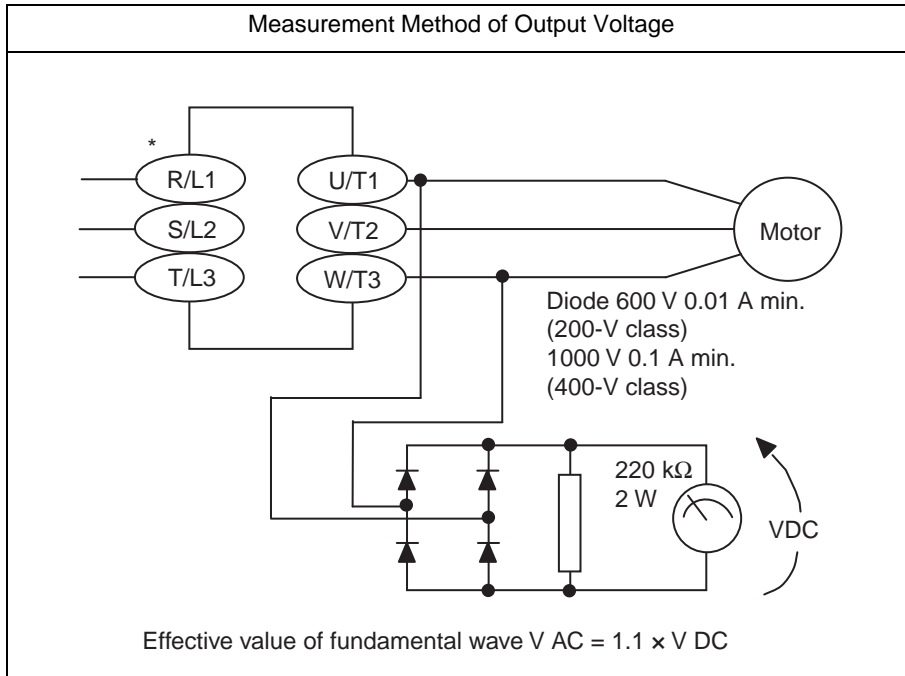

7

Specifications

* Terminal symbols for 3G3MX-AE□□□ are indicated as L1, L2, N/L3 instead of R/L1, S/L2, T/L3 respectively.

7-3 Connection Example

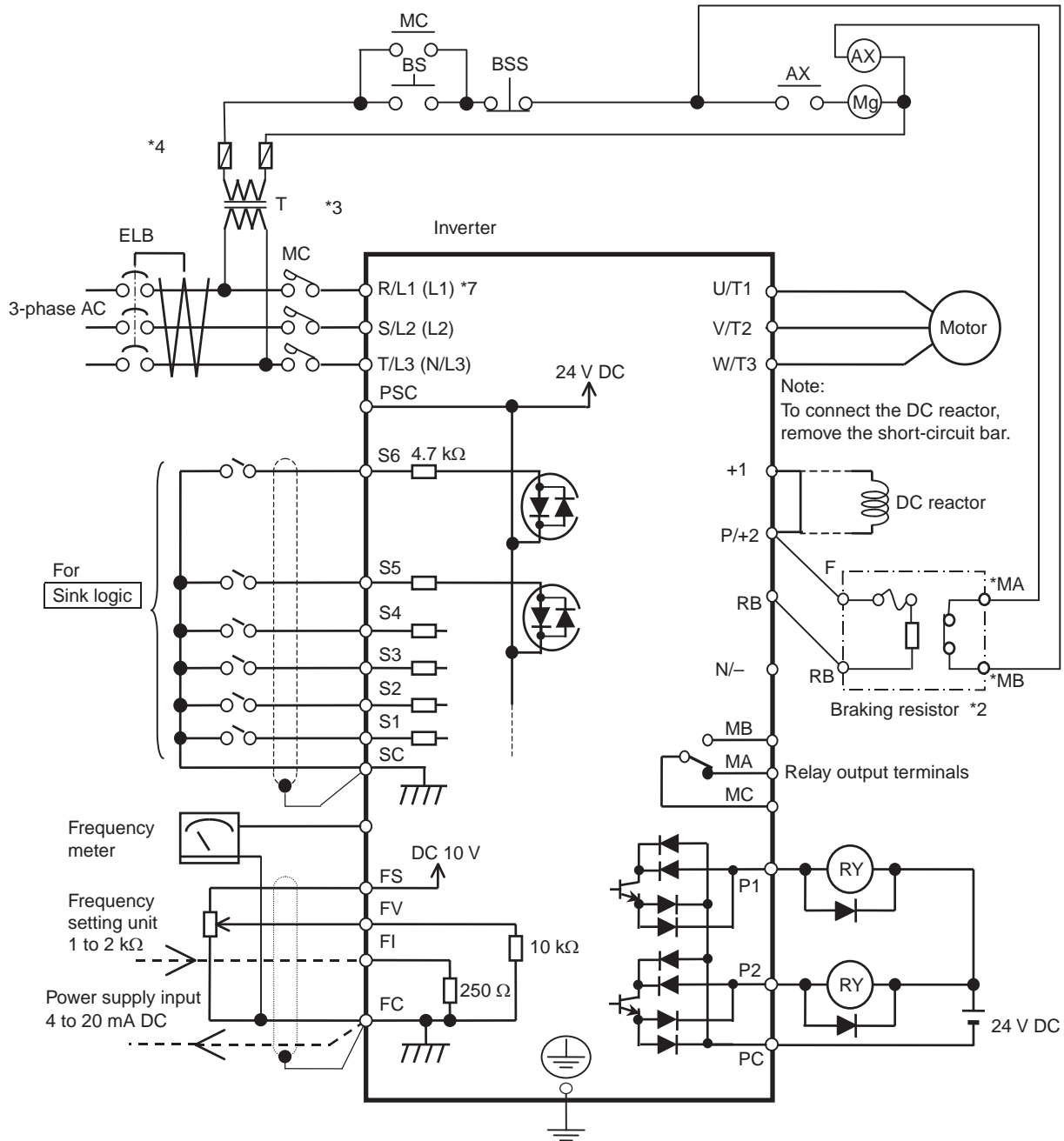

*1. Different terminals have different commons.

Terminals	S1, S2, S3, S4, S5, S6	AM	FS, FV, FI	P1, P2
Commons	Sink logic - SC	FC	PC	PC
	Source logic - PSC			

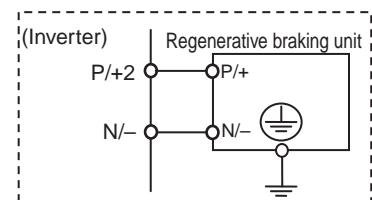

7-3 Connection Example

- *2. The braking resistor has a temperature relay. If the relay begins to operate, turn off the Inverter.
- *3. For 400-V power supply, install a step-down transformer.
- *4. Install a fuse in the operating circuit.
Not doing so may result in fire.
- *5. If the main circuit is turned on at the same time as a RUN command is input, the motor begins to rotate at least 2.0 seconds later.
- *6. Do not turn off the main circuit power supply during operation.
- *7. Terminal symbols for 3G3MX-AE□□□ are indicated in parentheses ().

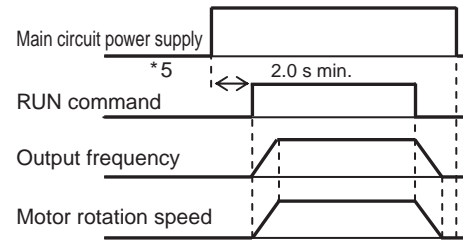

7-4 Dimensional Drawing

■3G3MX-A2002/-AE002

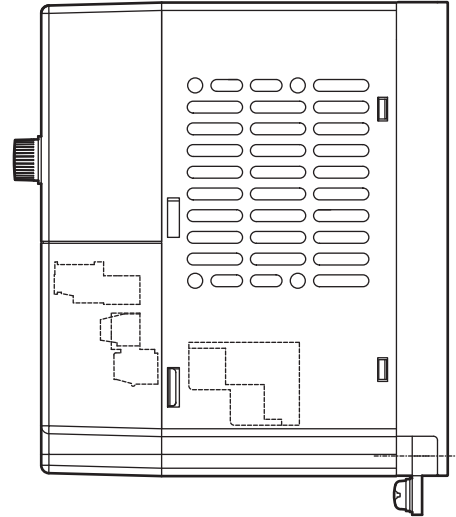
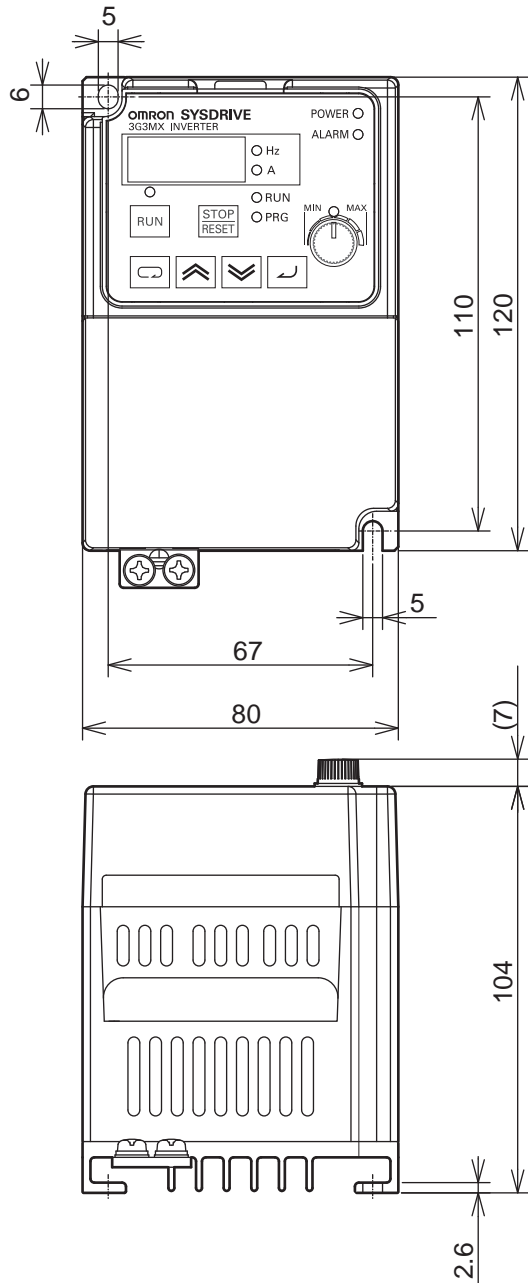

7

Specifications

■3G3MX-A2004/-AE004

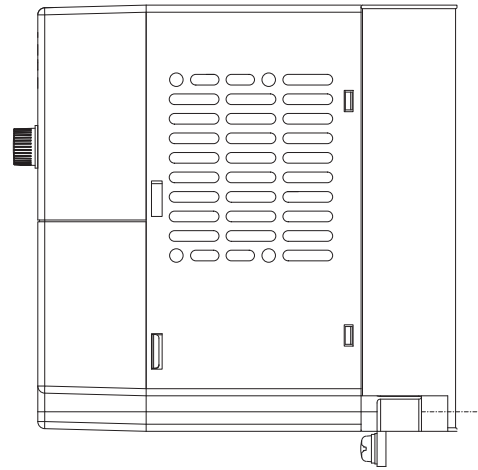
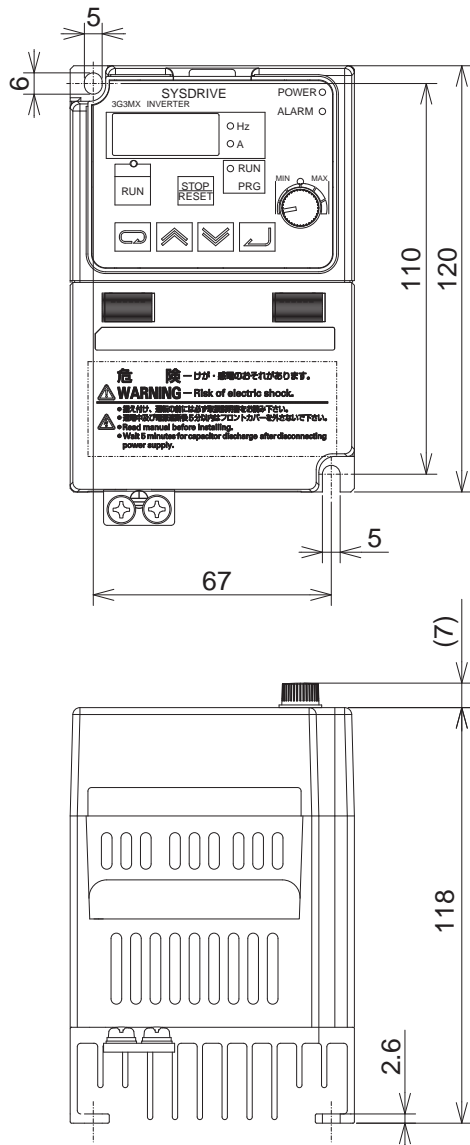

7

Specifications

■3G3MX-A2007

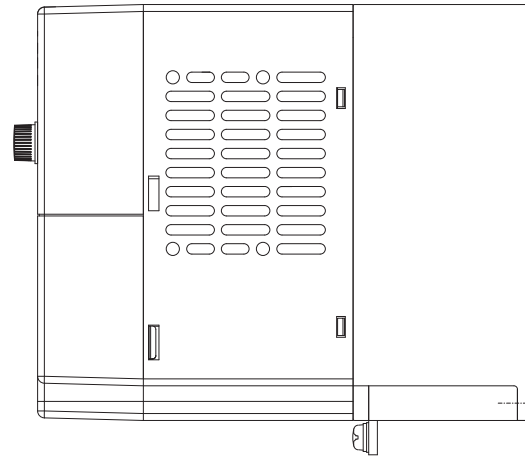
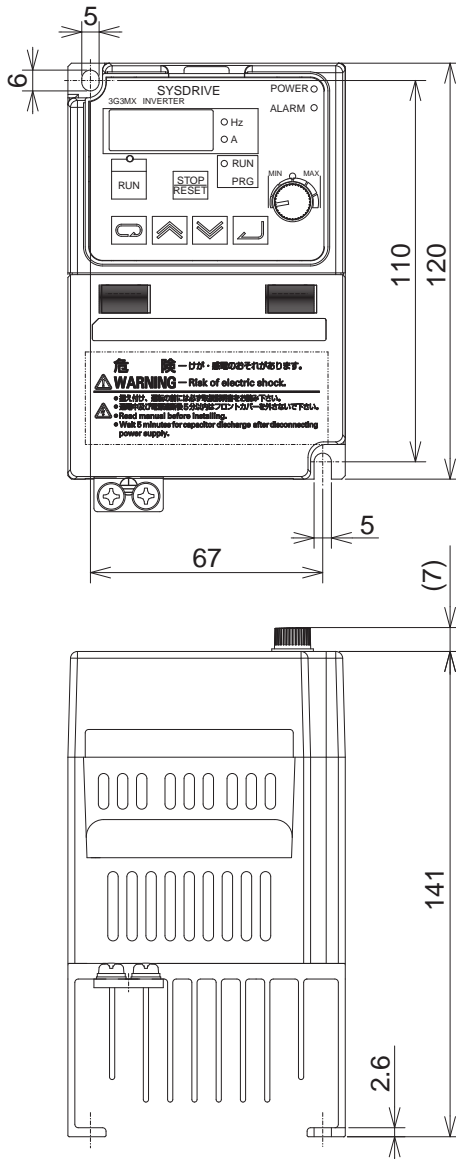

7

Specifications

■3G3MX-A4004/-AE007

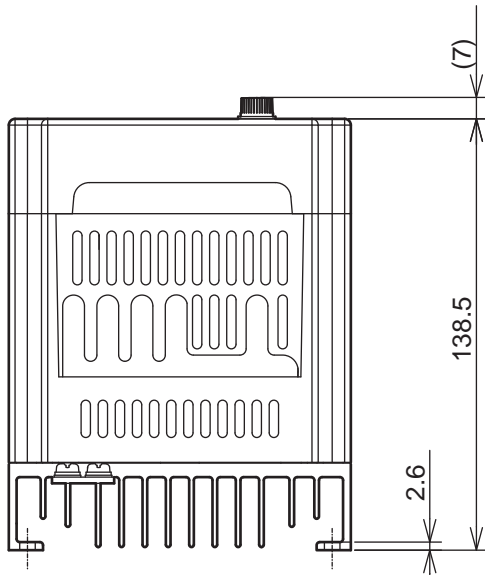
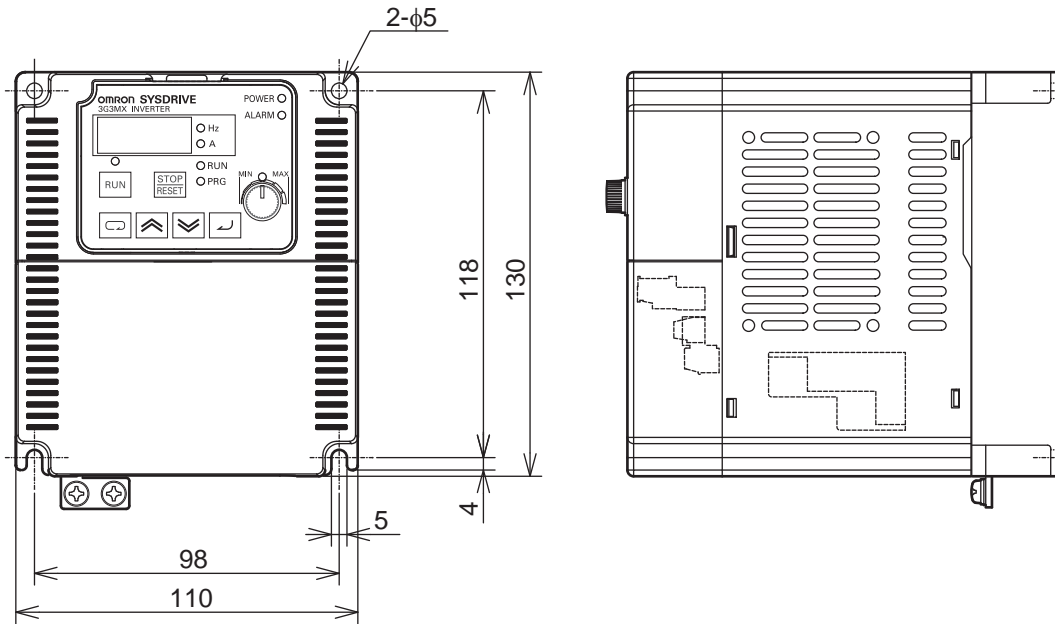

7

Specifications

■3G3MX-A2015/-A2022/-A2037/-A4007/-A4015/-A4022/-A4037/-AE015/-AE022

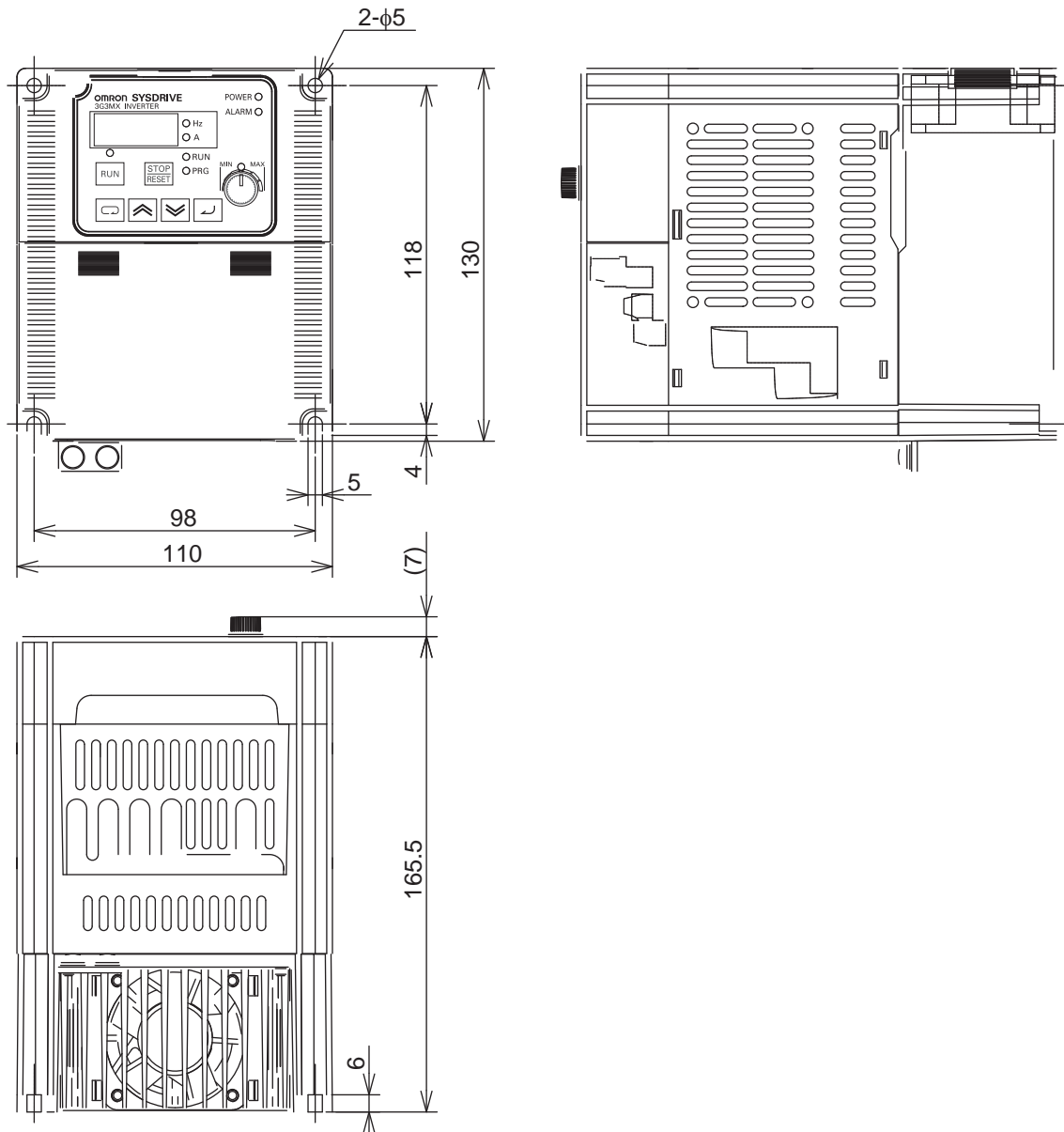

7

Specifications

■3G3MX-A2055/-A2075/-A4055/-A4075

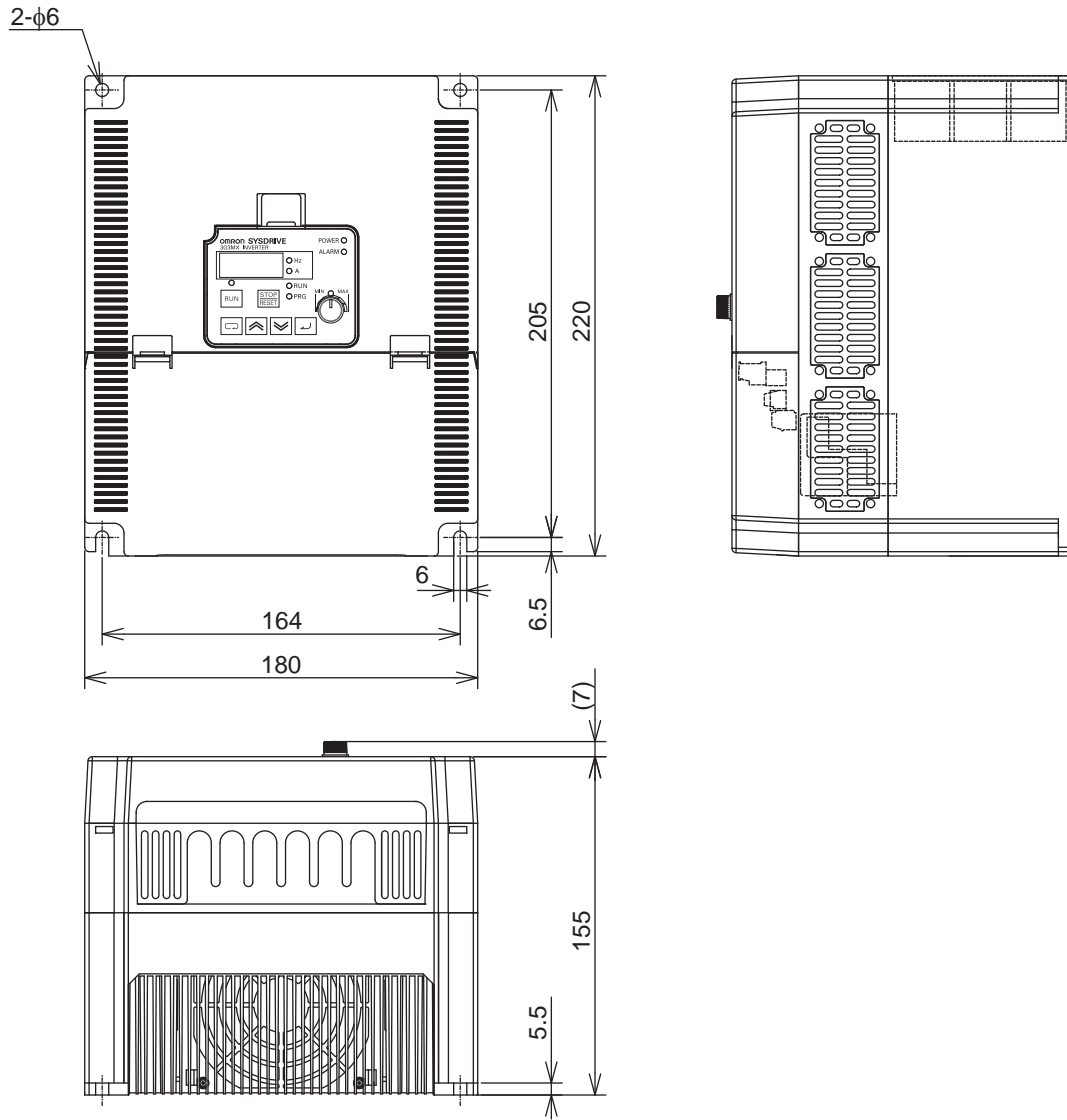

7

Specifications

7-5 Options

Regenerative Braking Unit (3G3AX-RBU Series)

■ Dimensional Drawing

3G3AX-RBU21/-RBU22

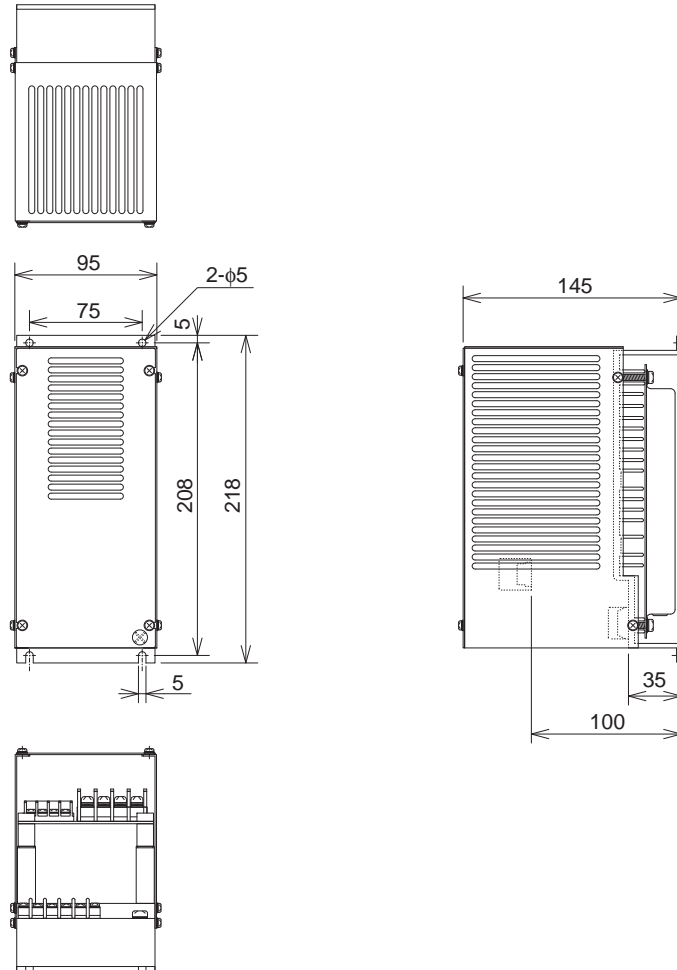

3G3AX-RBU41

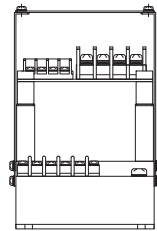
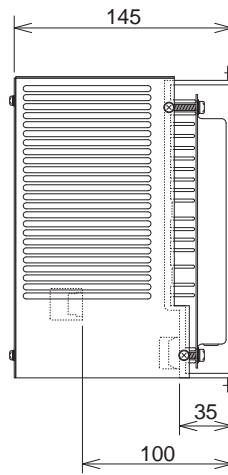
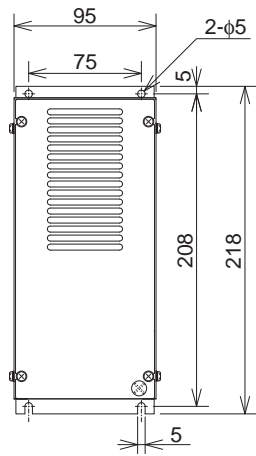
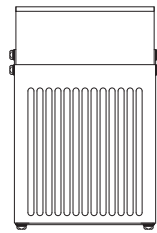

■ Specifications

Applicable voltage class	200-V class		400-V class	
Model	3G3AX-RBU21	3G3AX-RBU22	3G3AX-RBU41	
Connection resistance	17 Ω min.	17 Ω min.	34 Ω min.	
Operating voltage ON/OFF	ON : 362.5 ± 5 V OFF: 355 ± 5 V		ON : 725 ± 5 V OFF: 710 ± 5 V	
Operation indication	LED ON (Lit)			
Parallel interlocking operation function	5 units max.			
Built-in resistor	Resistance	120 W, 180 Ω	120 W, 20 Ω	120 W, 180 Ω × 2 in series
	Allowable consecutive ON time	10 s max.	0.5 s max.	10 s max.
	Allowable operation cycle	Cycle 1/10 (ON for 10 s, OFF for 90 s)	Cycle 1/80 (ON for 0.5 s, OFF for 40 s)	Cycle 1/10 (ON for 10 s, OFF for 90 s)
	Power consumption	Instantaneous 0.73 kW Short-time rating 120 W	Instantaneous 6 kW Short-time rating 120 W	Instantaneous 0.73 kW Rating 120 W × 2 in series
	Protective Functions	(1) The temperature relay operates if the internal resistor reaches approx. 200°C, and recovers at approx. 170°C (NC) Rating of contact 240 V AC 3 A (R load), 0.2 A (L load) 36 V DC 2 A (R load) Minimum load 240 V AC 25 mA (2) Built-in fuse in the internal resistor (recovery impossible)		
Operating environment	Ambient temperature	-10°C to 50°C		
	Ambient storage temperature	-20°C to 65°C (short-time temperature during transport)		
	Humidity	20% to 90% (with no condensation)		
	Vibration	5.9 m/s ² (0.6G) 10 to 55 Hz		
	Location	At a maximum altitude of 1,000 m; indoors (without corrosive gases or dust)		

Braking Resistor (3G3AX-RBA/RBB Series)

■ Dimensional Drawing

3G3AX-RBA Series

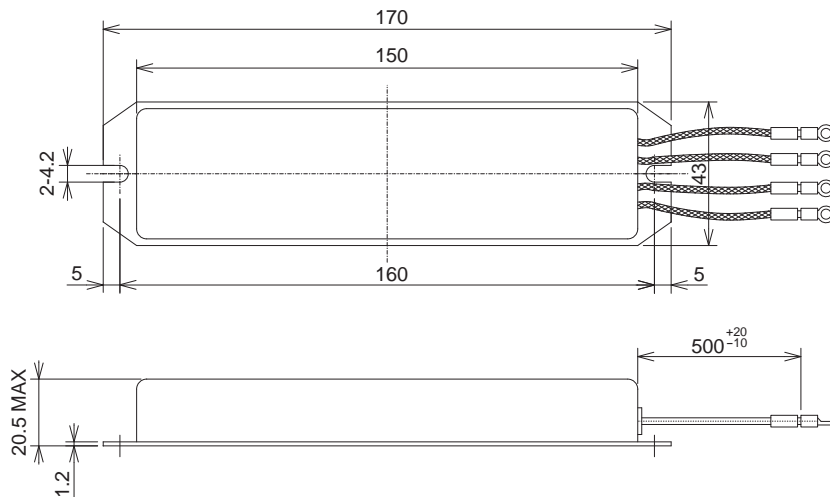

3G3AX-RBB Series

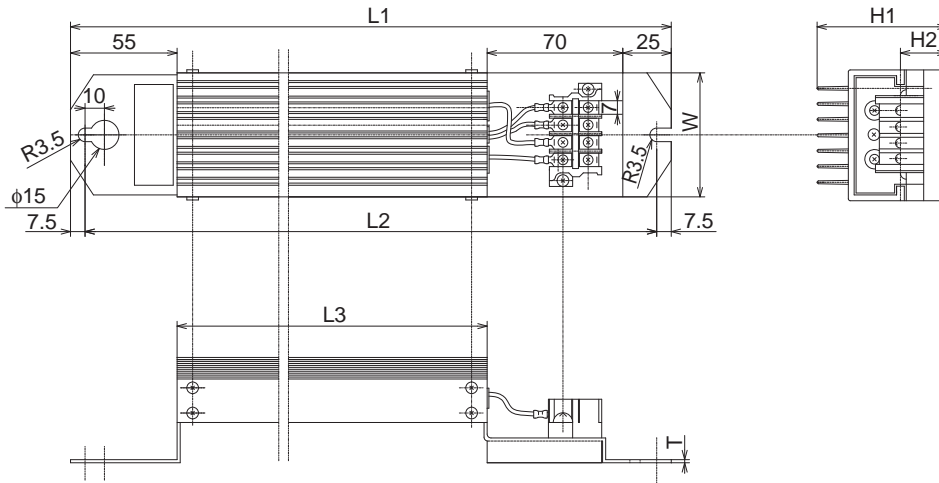

Model	Rated capacity (W)	Resistance (Ω)	Dimensions (mm)							Weight (kg)
			L1	L2	L3	H1	H2	W	T	
3G3AX-RBB2001	200	180	310	295	160	67	12	64	1.6	0.97
3G3AX-RBB2002	200	100	310	295	160	67	12	64	1.6	0.97
3G3AX-RBB3001	300	50	470	455	320	67	12	64	1.6	1.68
3G3AX-RBB4001	400	35	435	422	300	94	15	76	2	2.85

Specifications

Model		Compact type (3G3AX-RBA□□□□)				Standard type (3G3AX-RBB□□□□)			
		1201	1202	1203	1204	2001	2002	3001	4001
Resistance	Capacity	120 W	120 W	120 W	120 W	200 W	200 W	300 W	400 W
	Resistance (Ω)	180	100	50	35	180	100	50	35
Allowable braking frequency (%)		5	2.5	1.5	1.0	10	7.5	7.5	7.5
Continuous allowable braking time (s)		20	12	5	3	30	30	30	20
Weight (kg)		0.27	0.27	0.27	0.27	0.97	0.97	1.68	2.85
Fault detection function		Built-in thermal (Contact capacity: 240 V AC 2 A max. Minimum current: 5 mA), Normally ON (NC) Built-in temperature fuse (recovery impossible)							
General specifications	Ambient temperature	-10°C to 50°C							
	Humidity	20% to 90% (RH) with no condensation							
	Vibration	5.9 m/s(0.6 G) 10 to 55 Hz Complies with JISC0911							
	Location	At a maximum altitude of 1,000 m; indoors (without corrosive gases or dust)							
	Cooling method	Self-cooling							

DC Reactor (3G3AX-DL Series)

■ Dimensional Drawing

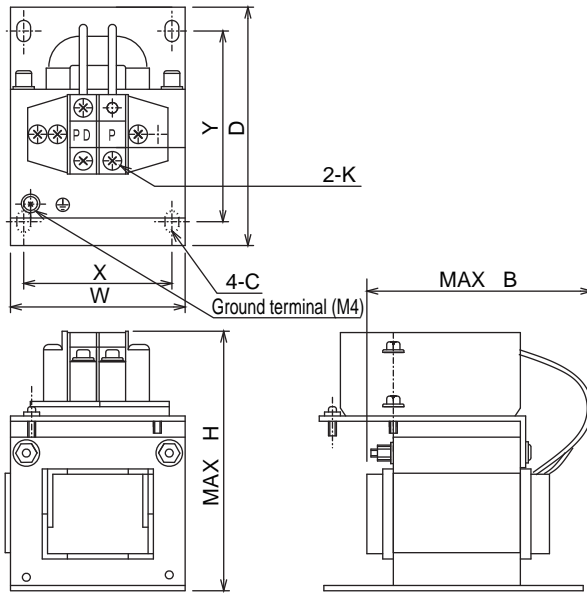

Figure 1

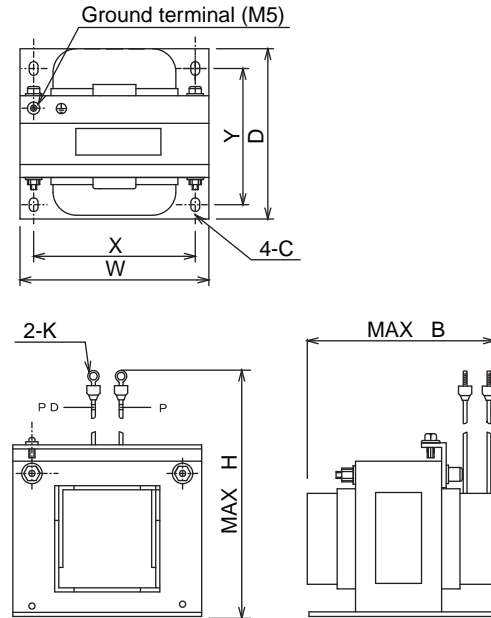

Figure 2

■ Specifications

Inverter input power supply	Model	Figure No.	Applicable Inverter capacity (kw)	Dimensions (mm) Bmax: coil dimensions							Weight (kg)	Standard applicable wire	
				W	D	H	B	X	Y	C			K
3/1-phase 200 V AC	3G3AX-DL2002	Fig. 1	0.2	66	90	98	85	56	72	5.2 × 8	M4	0.8	1.25 mm ² min.
	3G3AX-DL2004		0.4	66	90	98	95	56	72	5.2 × 8	M4	1.0	1.25 mm ² min.
	3G3AX-DL2007		0.75	66	90	98	105	56	72	5.2 × 8	M4	1.3	2 mm ² min.
	3G3AX-DL2015		1.5	66	90	98	115	56	72	5.2 × 8	M4	1.6	2 mm ² min.
	3G3AX-DL2022		2.2	86	100	116	105	71	80	6 × 9	M4	2.1	2 mm ² min.
	3G3AX-DL2037		3.7	86	100	118	120	71	80	6 × 9	M4	2.6	3.5 mm ² min.
	3G3AX-DL2055	Fig. 2	5.5	111	100	210	110	95	80	7 × 11	M5	3.6	8 mm ² min.
	3G3AX-DL2075		7.5	111	100	212	120	95	80	7 × 11	M6	3.9	14 mm ² min.

Inverter input power supply	Model	Figure No.	Applicable Inverter capacity (kw)	Dimensions (mm) Bmax: coil dimensions								Weight (kg)	Standard applicable wire
				W	D	H	B	X	Y	C	K		
3-phase 400 V AC	3G3AX-DL4004	Fig. 1	0.4	66	90	98	85	56	72	5.2 × 8	M4	0.8	1.25 mm ² min.
	3G3AX-DL4007		0.75	66	90	98	95	56	72	5.2 × 8	M4	1.1	1.25 mm ² min.
	3G3AX-DL4015		1.5	66	90	98	115	56	72	5.2 × 8	M4	1.6	2 mm ² min.
	3G3AX-DL4022		2.2	86	100	116	105	71	80	6 × 9	M4	2.1	2 mm ² min.
	3G3AX-DL4037		3.7	86	100	116	120	71	80	6 × 9	M4	2.6	2 mm ² min.
	3G3AX-DL4055		5.5	111	100	138	110	95	80	7 × 11	M4	3.6	3.5 mm ² min.
	3G3AX-DL4075		7.5	111	100	138	115	95	80	7 × 11	M4	3.9	3.5 mm ² min.

Operating Environment

Ambient temperature	-10°C to 50°C
Humidity	20% to 90% RH (with no condensation)
Vibration	15 kW max. 5.9 m/s ² max. (0.6G) 10 to 55 Hz 22 kW max. 2.0 m/s ² max. (0.2G) 10 to 55 Hz
Location	At a maximum altitude of 1,000 m; indoors (without corrosive gases or dust)

7

Specifications

Radio Noise Filter

Dimensional Drawing

3G3AX-ZCL1

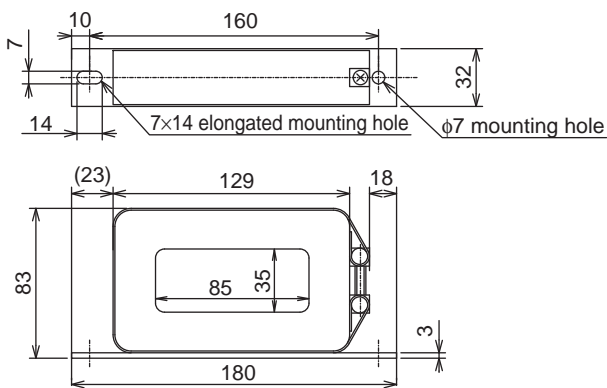

3G3AZ-ZCL2

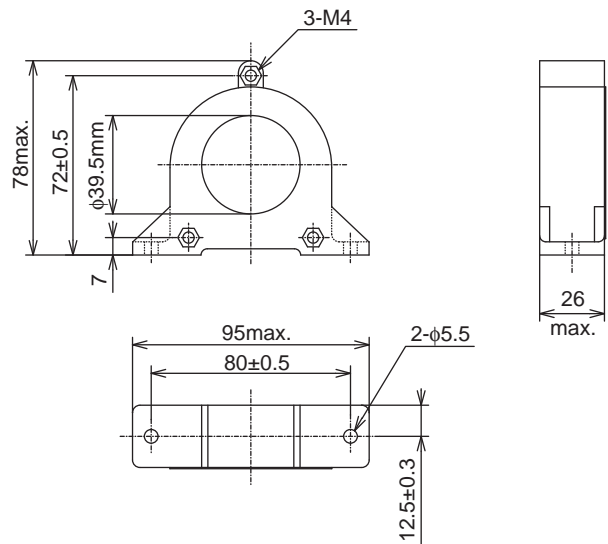

■ Specifications (3G3AX-ZCL1)

Applicable Inverter capacity (kw)	200-V class				400-V class			
	Input		Output		Input		Output	
	No. of filters	No. of penetrations	No. of filters	No. of penetrations	No. of filters	No. of penetrations	No. of filters	No. of penetrations
0.2	1	4	1	4	1	4	1	4
0.4	1	4	1	4	1	4	1	4
0.75	1	4	1	4	1	4	1	4
1.5	1	4	1	4	1	4	1	4
2.2	1	4	1	4	1	4	1	4
3.7	1	4	1	4	1	4	1	4
5.5	1	4	1	4	1	4	1	4
7.5	1	4	1	4	1	4	1	4

■ Specifications (3G3AX-ZCL2)

Applicable Inverter capacity (kw)	200-V class				400-V class			
	Input		Output		Input		Output	
	No. of filters	No. of penetrations	No. of filters	No. of penetrations	No. of filters	No. of penetrations	No. of filters	No. of penetrations
0.2	1	4	1	4	1	4	1	4
0.4	1	4	1	4	1	4	1	4
0.75	1	4	1	4	1	4	1	4
1.5	1	4	1	4	1	4	1	4
2.2	1	4	1	4	1	4	1	4
3.7	1	4	1	4	1	4	1	4
5.5	N/A		N/A		1	4	1	4
7.5					1	4	1	4

Input Noise Filter

■ Dimensional Drawing

3G3AX-NFI21

3G3AX-NFI22

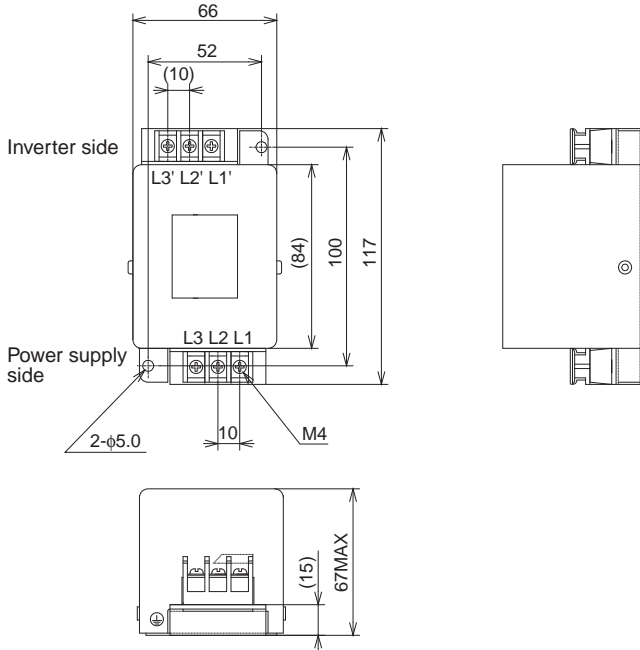

3G3AX-NFI23/3G3AX-NFI24

3G3AX-NFI41/3G3AX-NFI42

3G3AX-NFI43/

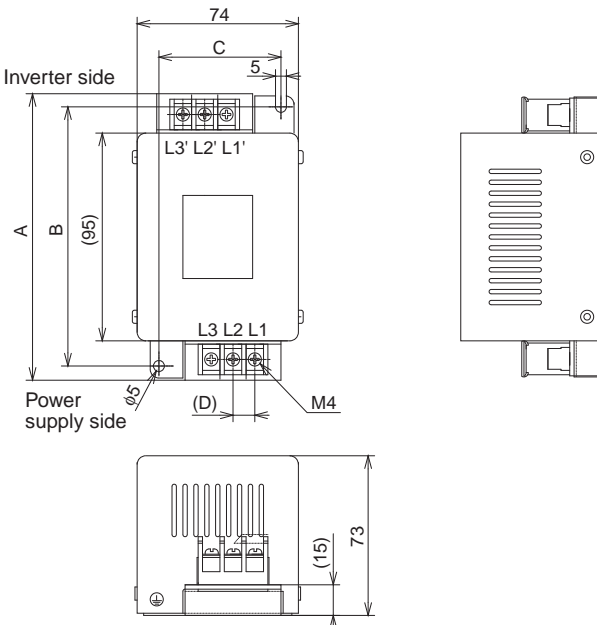

Model	Dimensions (Unit: mm)			
	A	B	C	D
3G3AX-NFI23	128	118	56	10
3G3AX-NFI24	144	130	56	11
3G3AX-NFI41	144	130	56	11
3G3AX-NFI42	144	130	56	11
3G3AX-NFI43	144	130	56	11

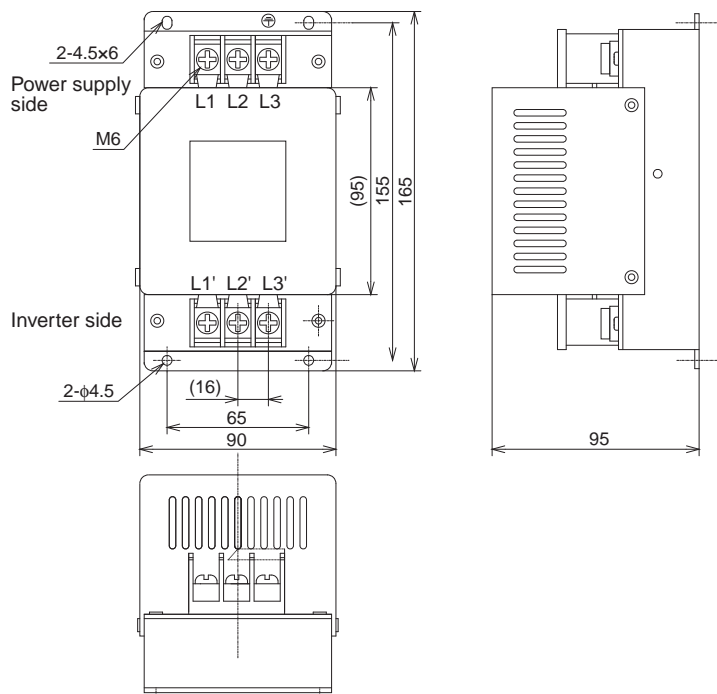
3G3AX-NFI25**■ Specifications (3G3AX-NFI Series)**

Power supply	Model	Applicable Inverter capacity (kw)	Rated input current In (A) at an ambient temperature of 50°C	Power loss (W)	Leakage current (mA/phase) at 60 Hz
3-phase 250 V +10% Max.	3G3AX-NFI21	0.2 to 0.75	3 × 6 A	3	< 1.5 (250 V)
	3G3AX-NFI22	1.5	3 × 10 A	4	< 1.5 (250 V)
	3G3AX-NFI23	2.2, 3.7	3 × 20 A	6	< 1.5 (250 V)
	3G3AX-NFI24	5.5	3 × 30 A	9	< 1.5 (250 V)
	3G3AX-NFI25	7.5	3 × 40 A	12	< 1.5 (250 V)
3-phase 480 V +10% Max.	3G3AX-NFI41	0.4 to 2.2	3 × 7 A	2	< 7.5 (480 V)
	3G3AX-NFI42	3.7	3 × 10 A	4	< 7.5 (480 V)
	3G3AX-NFI43	5.5, 7.5	3 × 20 A	6	< 7.5 (480 V)

Model	Case enclosure rating	Terminal size	Wire dia.	Weight (kg)
3G3AX-NFI21	Plastic, IP00	M4	1.25 mm ²	0.5
3G3AX-NFI22	Plastic, IP00	M4	2 mm ²	0.6
3G3AX-NFI23	Plastic, IP00	M4	2.35 mm ²	0.7
3G3AX-NFI24	Plastic, IP00	M4	5.5 mm ²	0.8
3G3AX-NFI25	Plastic, IP00	M5	8 mm ²	1.4
3G3AX-NFI41	Plastic, IP00	M4	1.25 mm ² , 2 mm ²	0.7
3G3AX-NFI42	Plastic, IP00	M4	2 mm ²	0.7
3G3AX-NFI43	Plastic, IP00	M4	2 mm ² , 3.5 mm ²	0.7

EMC-compatible Noise Filter

■ Dimensional Drawing

3G3AX-EFIB1/-EFI21

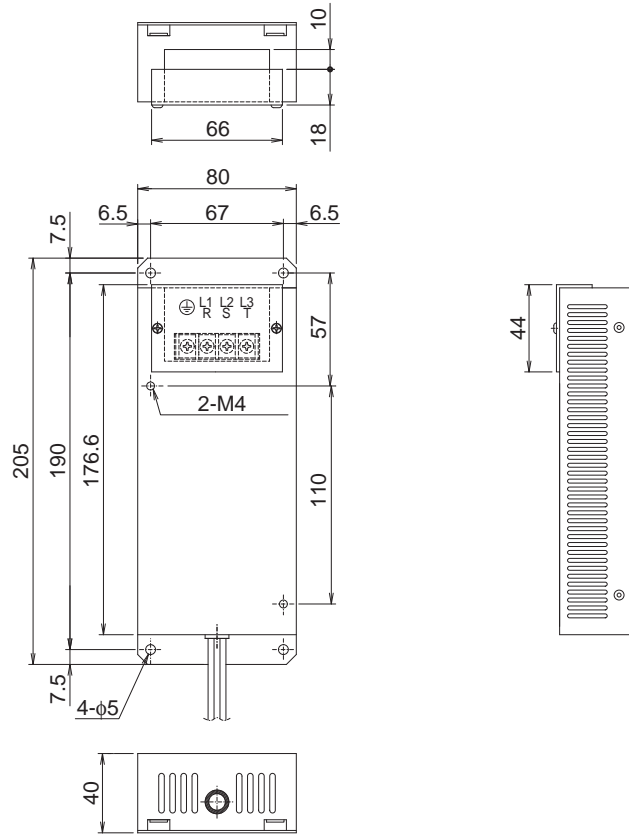

3G3AX-EFIB2/-EF122

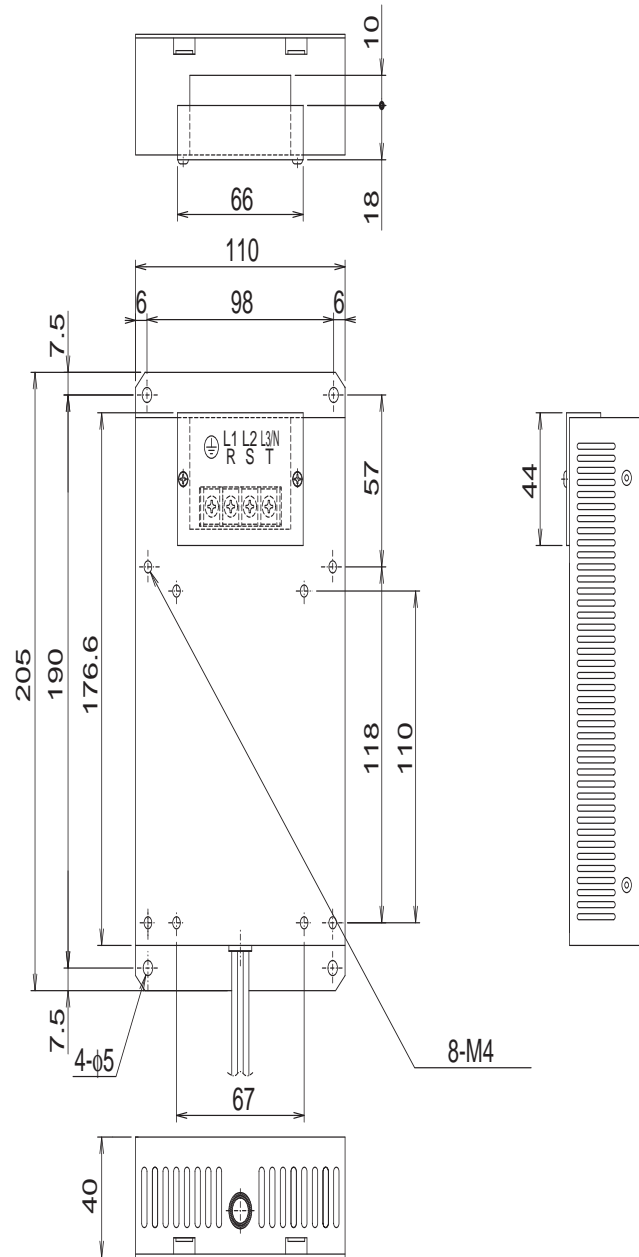

3G3AX-EFIB3/-EFI23

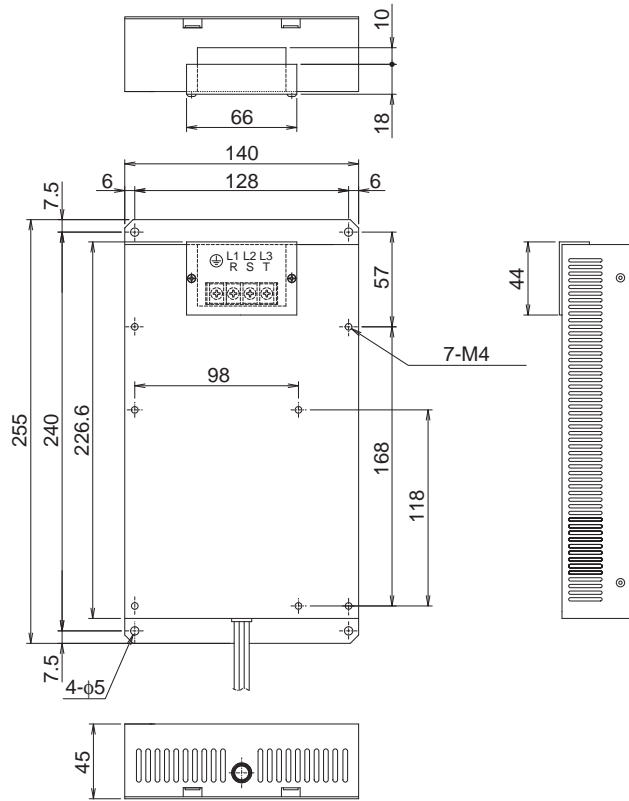

3G3AX-EFI24

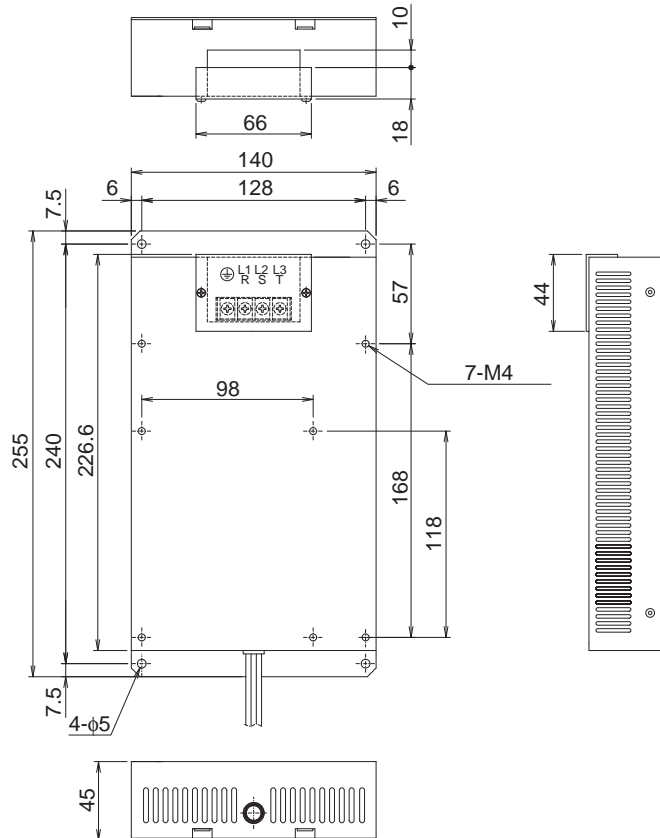

3G3AX-EFI25

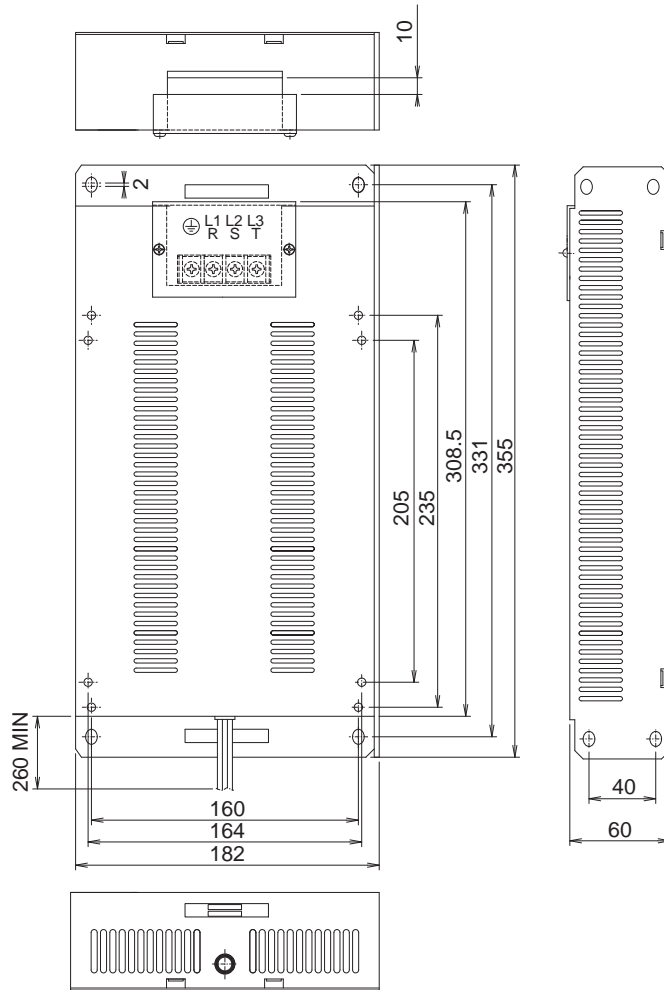

7

Specifications

3G3AX-EFI41/-EFI42

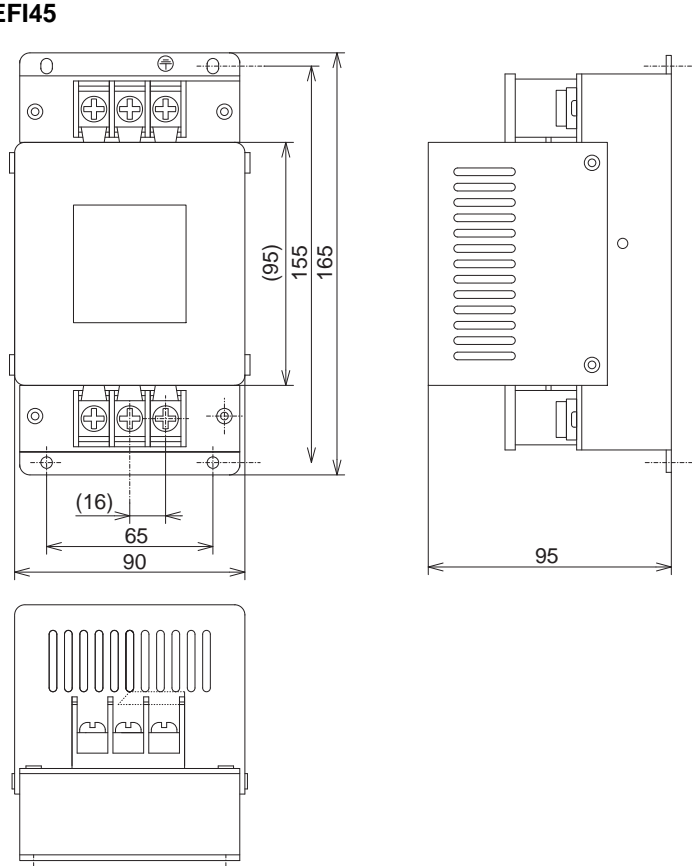
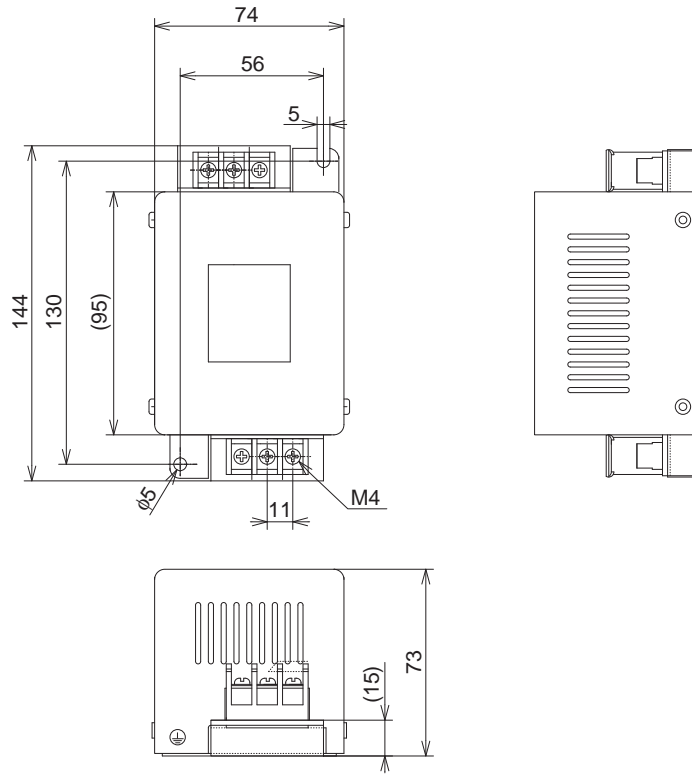

7

Specifications

■ Specifications (3G3AX-EFI Series)

Power supply	Model	Applicable Inverter capacity (kw)			Input current In (A)	Leakage current (mA/phase at 60 Hz)	Leakage current (mA/phase at 50 Hz)
		1-phase 200 V	3-phase 200 V	3-phase 400 V			
1-phase 200 V AC	3G3AX-EFIB1	0.2, 0.4	—	—	2 × 6 A	—	< 9
	3G3AX-EFIB2	0.75	—	—	2 × 10 A	—	< 9
	3G3AX-EFIB3	1.5, 2.2	—	—	2 × 21 A	—	< 9
3-phase 200 V AC	3G3AX-EFI21	—	0.2, 0.4	—	3 × 4 A	15 mA	< 3.5
	3G3AX-EFI22	—	0.75	0.4 to 1.5	3 × 5.2 A	16 mA	< 3.5
	3G3AX-EFI23	—	1.5, 2.2	2.2, 3.7	3 × 14 A	16 mA	< 3.5
	3G3AX-EFI24	—	3.7	—	3 × 22 A	16 mA	< 3.5
	3G3AX-EFI25	—	5.5, 7.5	5.5, 7.5	3 × 40 A	90 mA	< 3.5
3-phase 200/400 V AC	3G3AX-EFI41	—	0.4, 0.75	0.4 to 2.2	3 × 7 A	150 mA	< 7.5
	3G3AX-EFI42	—	1.5	3.7	3 × 10 A	150 mA	< 7.5
	3G3AX-EFI43	—	2.2, 3.7	5.5, 7.5	3 × 20 A	170 mA	< 7.5
	3G3AX-EFI44	—	5.5	—	3 × 30 A	170 mA	< 7.5
	3G3AX-EFI45	—	7.5	—	3 × 40 A	170 mA	< 7.5

Model	Case enclosure rating	Input terminal size	Input power supply wire size	Weight (kg)
3G3AX-EFIB1	Aluminum IP20	M4	3 × AWG16/1.3 mm ²	0.43
3G3AX-EFIB2	Aluminum IP20	M4	3 × AWG14/2.1 mm ²	0.6
3G3AX-EFIB3	Aluminum IP20	M4	3 × AWG12 to 10/3.3 to 5.3 mm ²	0.88
3G3AX-EFI21	Aluminum IP20	M4	4 × AWG16/1.3 mm ²	0.56
3G3AX-EFI22	Aluminum IP20	M4	4 × AWG16/1.3 mm ²	0.72
3G3AX-EFI23	Aluminum IP20	M4	4 × AWG16/2.1 mm ²	1.2
3G3AX-EFI24	Aluminum IP20	M4	4 × AWG16/3.3 mm ²	1.3
3G3AX-EFI25	Aluminum IP20	M5	4 × AWG12 to 8/3.3 to 8.4 mm ²	2.4
3G3AX-EFI41	Plastic, IP00	M4	1.25 mm ² , 2 mm ²	0.7
3G3AX-EFI42	Plastic, IP00	M4	2 mm ²	0.7
3G3AX-EFI43	Plastic, IP00	M5	2 mm ² , 3.5 mm ²	1.0
3G3AX-EFI44	Plastic, IP00	M5	5.5 mm ²	1.3
3G3AX-EFI45	Plastic, IP00	M5	8 mm ²	1.4

Output Noise Filter

■ Dimensional Drawing

3G3AX-NFO01/-NFO02

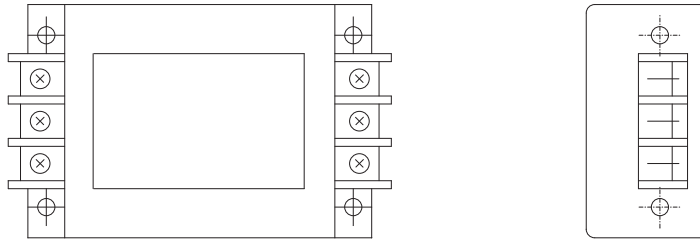

3G3AX-NFO03/-NFO04

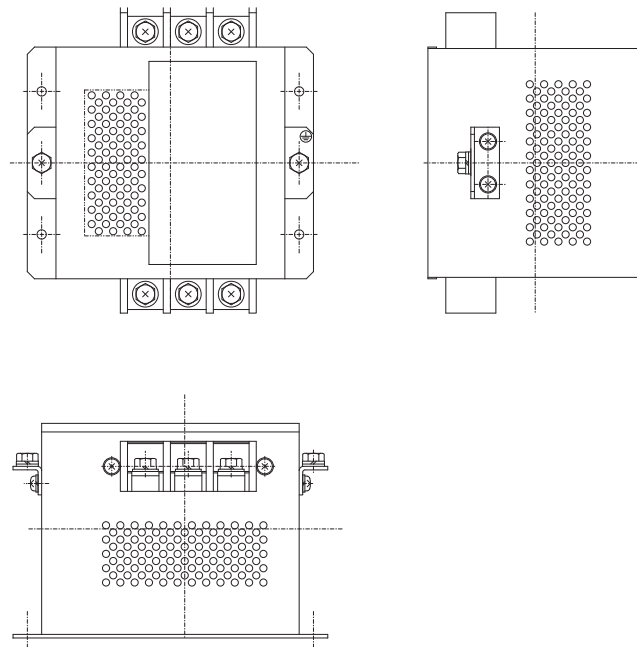

■ Specifications (3G3AX-NFO Series)

Power supply	Model	Rated current (A)	Applicable motor (kW)		External dimensions (Height × Width × Depth) (mm)	Weight (kg)
			200-V class	400-V class		
3-phase (3-wire) rated voltage 500 V AC	3G3AX-NFO01	6	0.75 max.	2.2 max.	156 × 95 × 50	0.7
	3G3AX-NFO02	12	1.5, 2.2	3.7	176 × 110 × 70	0.9
	3G3AX-NFO03	25	3.7, 5.5	5.5, 7.5	154 × 160 × 120	2.1
	3G3AX-NFO04	50	7.5	—	210 × 200 × 150	3.7

AC Reactor

■ Dimensional Drawing

3G3AX-AL2025/-AL2055

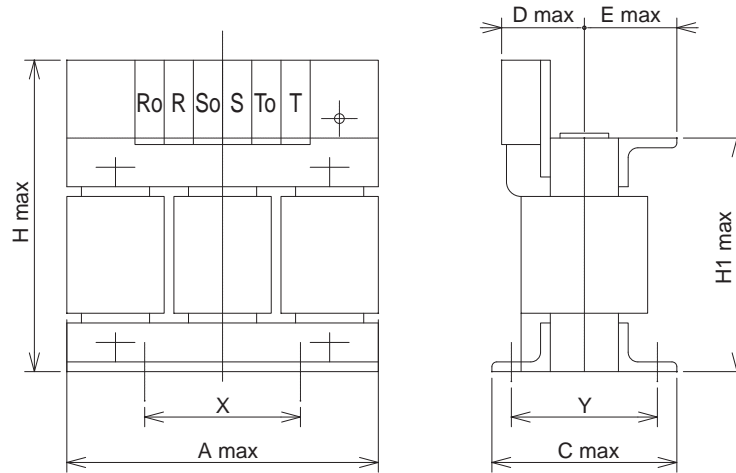

3G3AX-AL2110

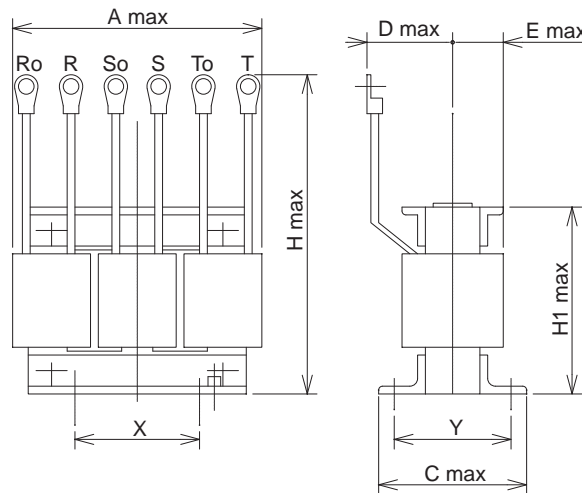

3G3AX-AL4025/-AL4055/-AL4110

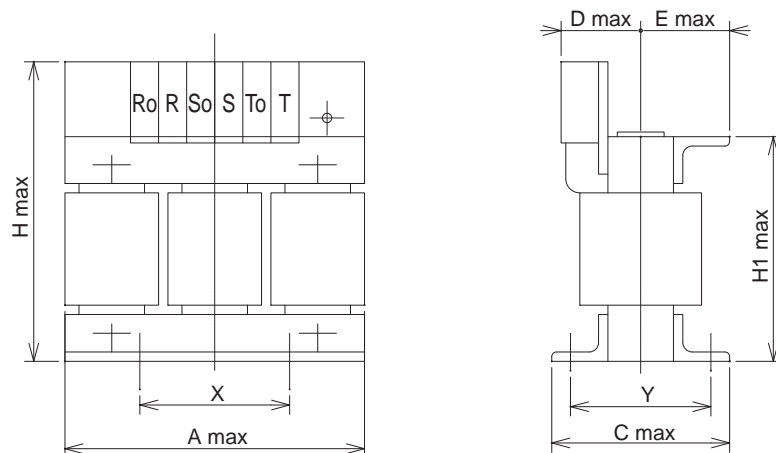

■ Specifications (3G3AX-AL Series)

Power supply	Model	Applicable Inverter capacity (kw)	External dimensions								Weight (kg)
			A	C	D	E	H	H1	X	Y	
3-phase 200 V AC	3G3AX-AL2025	0.2 to 1.5	130	82	60	40	150	92	50	67	2.8
	3G3AX-AL2055	2.2, 3.7	140	98	60	40	150	92	50	75	4.0
	3G3AX-AL2110	5.5, 7.5	160	103	70	55	170	106	60	80	5.0
3-phase 400 V AC	3G3AX-AL4025	0.4 to 1.5	130	82	60	40	150	92	50	67	2.7
	3G3AX-AL4055	2.2, 3.7	130	98	60	40	150	92	50	75	4.0
	3G3AX-AL4110	5.5, 7.5	160	116	75	55	170	106	60	98	6.0

Digital Operator

3G3AX-OP01

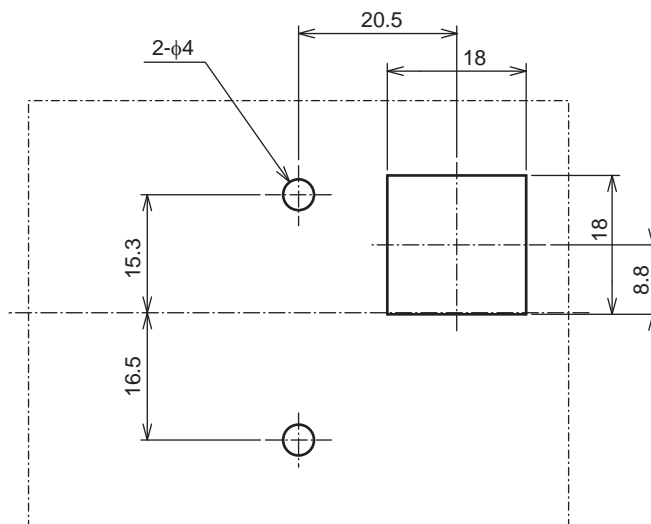
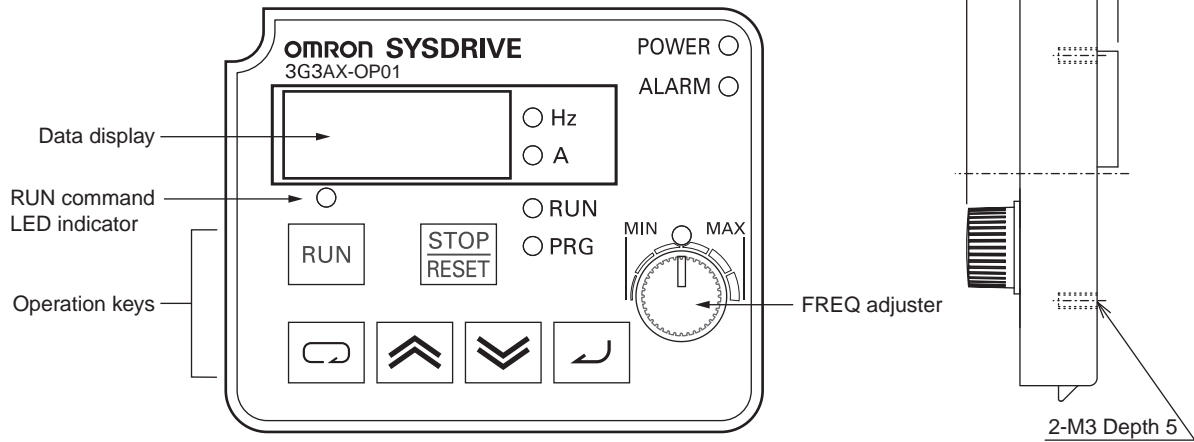

Panel cutout dimension



External dimensions	Height (55 mm) × Width (70 mm) × Depth (10 mm)
---------------------	--

Appendix

Appendix-1	Parameter List.....	App-1
Appendix-2	Product Life Curve.....	App-17

Appendix-1 Parameter List

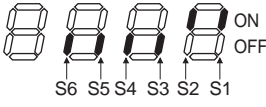
Monitor Mode (d□□□) / Basic Function Mode (F□□□)

Parameter No.	Function name	Monitor or data range (Digital Operator)	Default setting	Changes during operation	Unit	Set value
d001	Output frequency monitor	0.0 to 400.0	—	—	Hz	
d002	Output current monitor	0.0 to 999.9	—	—	A	
d003	Rotation direction monitor	F: Forward o: Stop r: Reverse	—	—	—	
d004	PID feedback value monitor	0.00 to 99.99 100.0 to 999.9 1000. to 9999.	—	—	—	
d005	Multi-function input monitor	 <p>Example) Terminal S2, S1: ON Terminal S6, S5, S4, S3: OFF</p>	—	—	—	
d006	Multi-function output monitor	 <p>Example) Terminal P1, P2: ON Terminal MA: OFF</p>	—	—	—	
d007	Output frequency monitor (after conversion)	0.00 to 99.99 100.0 to 999.9 1000. to 9999. 1000 to 3996 (10000 to 39960) (Output frequency × Conversion factor of b086)	—	—	—	
d013	Output voltage monitor	0. to 600.	—	—	V	
d016	Total RUN time	0. to 9999. 1000 to 9999 ┌100 to ┌999[h]	—	—	h	
d017	Power ON time monitor	0. to 9999. 1000 to 9999 ┌100 to ┌999[h]	—	—	h	
d080	Fault frequency monitor	0. to 9999.	—	—	—	
d081	Fault monitor 1 (Latest)	Error code (condition of occurrence) →	—	—		
d082	Fault monitor 2	Output frequency [Hz] → Output current [A]				
d083	Fault monitor 3	→ Internal DC voltage [V] → RUN time [h] → ON time [h]				

*2nd control is displayed when '08 (2nd control)' is allocated to one of multi-function inputs from C001 to C006.

Parameter No.	Function name	Monitor or data range (Digital Operator)	Default setting	Changes during operation	Unit	Set value
F001	Output frequency setting/monitor	0.0/Starting frequency to 400.0	—	Yes	Hz	
F002	Acceleration time 1	0.01 to 99.99 100.0 to 999.9 1000. to 3000.	10.0	Yes	s	
F202	* 2nd acceleration time 1	0.01 to 99.99 100.0 to 999.9 1000. to 3000.	10.0	Yes	s	
F003	Deceleration time 1	0.01 to 99.99 100.0 to 999.9 1000. to 3000.	10.0	Yes	s	
F203	* 2nd deceleration time 1	0.01 to 99.99 100.0 to 999.9 1000. to 3000.	10.0	Yes	s	
F004	Operator rotation direction selection	00: Forward 01: Reverse	00	No	—	

*2nd control is displayed when '08 (2nd control)' is allocated to one of multi-function inputs from C001 to C006.

Extended Function Mode

Parameter No.	Function name	Monitor or data range (Digital Operator)	Default setting	Changes during operation	Unit	Set value
Basic setting	A001	Frequency reference selection	00: Digital Operator (FREQ adjuster) 01: Terminal	00	No	—
	A201	*2nd frequency reference selection	02: Digital Operator (F001) 03: Modbus communication 10: Frequency operation result	00	No	—
	A002	RUN command selection	01: Terminal	02	No	—
	A202	*2nd RUN command selection	02: Digital Operator 03: Modbus communication	02	No	—
	A003	Base frequency	30. to Max. frequency [A004]	60.	No	Hz
	A203	*2nd base frequency	30 to Max. frequency [A204]	60.		
	A004	Maximum frequency	30. to 400.	60.	No	Hz
	A204	*2nd maximum frequency		60.		
Analog input	A005	FV/FI selection	00: Switches between FV/FI via terminal AT 01: Disabled (Outputs FV+FI) 02: Switches between FV/VR via terminal AT 03: Switches between FI/VR via terminal AT	00	No	—
	A011	FV start frequency	0.0 to Max. frequency	0.0	No	Hz
	A012	FV end frequency	0.0 to Max. frequency	0.0	No	Hz
	A013	FV start ratio	0. to 100.	0.	No	%
	A014	FV end ratio	0. to 100.	100.	No	%
	A015	FV start selection	00: External start frequency (A011 set value) 01: 0 Hz	01	No	—
	A016	FV, FI sampling	1. to 17.	8.	No	—

*2nd control is displayed when '08 (2nd control)' is allocated to one of multi-function inputs from C001 to C006.

Parameter No.	Function name	Monitor or data range (Digital Operator)	Default setting	Changes during operation	Unit	Set value			
Multi-step speed, Jogging	A020	Multi-step speed reference 0	0.0/Starting frequency to Max. frequency	6.0	Yes	Hz			
	A220	*2nd multi-step speed reference 0	0.0/Starting frequency to 2nd max. frequency	6.0	Yes	Hz			
	A021	Multi-step speed reference 1	0.0/Starting frequency to Max. frequency	0.0	Yes	Hz			
	A022	Multi-step speed reference 2		0.0					
	A023	Multi-step speed reference 3		0.0					
	A024	Multi-step speed reference 4		0.0					
	A025	Multi-step speed reference 5		0.0					
	A026	Multi-step speed reference 6		0.0					
	A027	Multi-step speed reference 7		0.0					
	A028	Multi-step speed reference 8		0.0					
	A029	Multi-step speed reference 9		0.0					
	A030	Multi-step speed reference 10		0.0					
	A031	Multi-step speed reference 11		0.0					
	A032	Multi-step speed reference 12		0.0					
	A033	Multi-step speed reference 13		0.0					
	A034	Multi-step speed reference 14		0.0					
	A035	Multi-step speed reference 15		0.0					
	A038	Jogging frequency		0.00/Starting frequency to 9.99			6.00	Yes	Hz
	A039	Jogging stop selection		00: Free-run stop 01: Deceleration stop 02: DC injection braking stop			00	No	—

*2nd control is displayed when '08 (2nd control)' is allocated to one of multi-function inputs from C001 to C006.

Appendix-1 Parameter List

Parameter No.	Function name	Monitor or data range (Digital Operator)	Default setting	Changes during operation	Unit	Set value
A042	Manual torque boost voltage	0.0 to 20.0	5.0	Yes	%	
A242	*2nd manual torque boost voltage		0.0			
A043	Manual torque boost frequency	0.0 to 50.0	3.0	Yes	%	
A243	*2nd manual torque boost frequency		0.0			
A044	V/f characteristics selection	00: Constant torque characteristics (VC) 01: Special reduced torque characteristics (Special VP) 02: Intelligent sensor-less vector control (iSLV)	02	No	—	
A244	*2nd V/f characteristics selection		00			
A045	Output voltage gain	20. to 100.	100.	Yes	%	
A245	*2nd output voltage gain		100.			
A046	Automatic torque boost voltage compensation gain	0. to 255.	100.	Yes	%	
A246	*2nd automatic torque boost voltage compensation gain		100.			
A047	Automatic torque boost slip compensation gain	0. to 255.	100.	Yes	%	
A247	*2nd automatic torque boost slip compensation gain		100.			

*2nd control is displayed when '08 (2nd control)' is allocated to one of multi-function inputs from C001 to C006.

Parameter No.	Function name	Monitor or data range (Digital Operator)	Default setting	Changes during operation	Unit	Set value
DC injection braking	A051	DC injection braking selection	00: Disabled 01: Enabled	00	No	—
	A052	DC injection braking frequency	0.0 to 60.0	0.5	No	Hz
	A053	DC injection braking delay time	0.0 to 5.0	0.0	No	s
	A054	DC injection braking power	0. to 100.	50.	No	%
	A055	DC injection braking time	0.0 to 60.0	0.5	No	s
	A056	DC injection braking method selection	00: Edge operation 01: Level operation	01	No	—
Upper/Lower limit, Jump	A061	Frequency upper limit	0.0/Frequency lower limit to Max. frequency	0.0	No	Hz
	A261	*2nd frequency upper limit	0.0/Frequency lower limit to 2nd Max. frequency	0.0		
	A062	Frequency lower limit	0.0/Starting frequency to Frequency upper limit	0.0	No	Hz
	A262	*2nd frequency lower limit	0.0/Starting frequency to 2nd frequency upper limit	0.0		
	A063	Jump frequency 1	Jump frequency: 0.0 to 400.0 Jump frequency width: 0.0 to 10.0	0.0	No	Hz
	A064	Jump frequency width 1		0.5		
	A065	Jump frequency 2		0.0		
	A066	Jump frequency width 2		0.5		
A067	Jump frequency 3	0.0				
A068	Jump frequency width 3	0.5				

*2nd control is displayed when '08 (2nd control)' is allocated to one of multi-function inputs from C001 to C006.

Appendix-1 Parameter List

Parameter No.	Function name	Monitor or data range (Digital Operator)	Default setting	Changes during operation	Unit	Set value
PID control	A071	PID selection	00: Disabled 01: Enabled	00	No	—
	A072	PID P gain	0.2 to 5.0	1.0	Yes	—
	A073	PID I gain	0.0 to 150.0	1.0	Yes	s
	A074	PID D gain	0.00 to 100.0	0.0	Yes	s
	A075	PID scale	0.01 to 99.99	1.00	No	Time
	A076	PID feedback selection	00: FI 01: FV 02: RS485 communication 10: Operation function output	00	No	—
	A077	Reverse PID function	00: OFF (Deviation = Target value - Feedback value) 01: ON (Deviation = Feedback value - Target value)	00	No	—
	A078	PID output limit function	0.00 to 100.0	0.0	No	%
AVR	A081	AVR selection	00: Always ON 01: Always OFF 02: OFF during deceleration	02	No	—
	A082	AVR voltage selection	200-V class: 200/215/220/230/240 400-V class: 380/400/415/440/460/480	200/ 400	No	V

*2nd control is displayed when '08 (2nd control)' is allocated to one of multi-function inputs from C001 to C006.

Parameter No.	Function name	Monitor or data range (Digital Operator)	Default setting	Changes during operation	Unit	Set value
RUN mode, Acceleration/Deceleration functions	A092	Acceleration time 2	0.01 to 99.99 100.0 to 999.9	15.00	Yes	s
	A292	*2nd acceleration time 2	1000. to 3000.	15.00		
	A093	Deceleration time 2	0.01 to 99.99 100.0 to 999.9	15.00	Yes	s
	A293	*2nd deceleration time 2	1000. to 3000.	15.00		
	A094	2-step acceleration/ deceleration selection	00: Switched via multi-function input 09 (2CH) 01: Switched by setting	00	No	—
	A294	*2nd 2-step acceleration/ deceleration selection		00		
	A095	2-step acceleration frequency	0.0 to 400.0	0.0	No	Hz
	A295	*2nd 2-step acceleration frequency		0.0		
	A096	2-step deceleration frequency	0.0 to 400.0	0.0	No	Hz
	A296	*2nd 2-step deceleration frequency		0.0		
	A097	Acceleration pattern selection	00: Line 01: S-shape curve	00	No	—
	A098	Deceleration pattern selection	00: Line 01: S-shape curve	00	No	—
External frequency adjustment	A101	FI start frequency	0.0 to 400.0	0.0	No	Hz
	A102	FI end frequency	0.0 to 400.0	0.0	No	Hz
	A103	FI start ratio	0. to 100.	0.	No	%
	A104	FI end ratio	0. to 100.	100.	No	%
	A105	FI start selection	00: Use FI start frequency [A101] 01: 0 Hz start	01	No	—

*2nd control is displayed when '08 (2nd control)' is allocated to one of multi-function inputs from C001 to C006.

Appendix-1 Parameter List

Parameter No.	Function name	Monitor or data range (Digital Operator)	Default setting	Changes during operation	Unit	Set value
Operation frequency	A141	Operation frequency input A setting	00: Digital Operator (F001) 01: Digital Operator (FREQ adjuster) 02: Input FV	02	No	—
	A142	Operation frequency input B setting	03: Input FI 04: RS485 communication	03	No	—
	A143	Operator selection	00: Addition (A + B) 01: Subtraction (A - B) 02: Multiplication (A × B)	00	No	—
Frequency addition	A145	Frequency addition amount	0.0 to 400.0	0.0	Yes	Hz
	A146	Frequency addition direction	00: Adds A145 value to output frequency 01: Subtract A145 value from output frequency	00	No	—
VR adjustment	A151	VR start frequency	0.0 to 400.0	0.0	No	Hz
	A152	VR end frequency	0.0 to 400.0	0.0	No	Hz
	A153	VR start ratio	0. to 100.	0.	No	%
	A154	VR end ratio	0. to 100.	100.	No	%
	A155	VR start selection	00: Use start frequency [A151] 01: 0 Hz start	01	No	—
Restart after momentary power interruption	b001	Retry selection	00: Alarm 01: 0 Hz start 02: Frequency matching start 03: Trip after frequency matching deceleration stop	00	No	—
	b002	Allowable momentary power interruption time	0.3 to 25.0	1.0	No	s
	b003	Retry wait time	0.3 to 100.0	1.0	No	s
	b004	Momentary power interruption/ undervoltage trip during stop selection	00: Disabled 01: Enabled	00	No	—
	b005	Momentary power interruption retry time selection	00: 16 times 01: No limit	00	No	—

*2nd control is displayed when '08 (2nd control)' is allocated to one of multi-function inputs from C001 to C006.

Parameter No.	Function name	Monitor or data range (Digital Operator)	Default setting	Changes during operation	Unit	Set value
Electronic thermal	b012	Electronic thermal level	0.2 x Rated current to 1.2 x Rated current	Rated current	No	A
	b212	*2nd electronic thermal level		Rated current		
	b013	Electronic thermal characteristics selection	00: Reduced torque characteristics 1 01: Constant torque characteristics 02: Reduced torque characteristics 2	00	No	—
	b213	*2nd electronic thermal characteristics selection		00		
Overload limit	b021	Overload limit selection	00: Disabled 01: Enabled in acceleration/constant speed operation 02: Enabled in constant speed operation	01	No	—
	b221	*2nd overload limit selection		01		
	b022	Overload limit level	0.1 x Rated current to 1.5 x Rated current	1.5 x Rated current	No	A
	b222	*2nd overload limit level		1.5 x Rated current		
	b023	Overload limit parameter	0.1 to 3000.0	1.0	No	s
	b223	*2nd overload limit parameter		1.0		
	b028	Overload limit source selection	00: b022, b222 set values 01: Input terminal FV	00	No	—
	b228	*2nd overload limit source selection		00		
Lock	b031	Soft lock selection	00: Data other than b031 cannot be changed when terminal SFT is ON. 01: Data other than b031 and the specified frequency parameter cannot be changed when terminal SFT is ON. 02: Data other than b031 cannot be changed. 03: Data other than b031 and the specified frequency parameter cannot be changed. 10: Data other than parameters changeable during operation cannot be changed.	01	No	—
Others	b080	AM adjustment	0. to 255. (Shared with C086 for AM offset adjustment)	100.	Yes	—
	b082	Starting frequency	0.5 to 9.9	0.5	No	Hz
	b083	Carrier frequency	2.0 to 14.0	5.0	No	kHz

*2nd control is displayed when '08 (2nd control)' is allocated to one of multi-function inputs from C001 to C006.

Appendix-1 Parameter List

Parameter No.	Function name	Monitor or data range (Digital Operator)	Default setting	Changes during operation	Unit	Set value
Initialization	b084	Initialization selection 00: Clears the trip monitor 01: Initializes data 02: Clears the trip monitor and initializes data	00	No	—	
	b085	Initialization parameter selection 00 * Do not change.	00	No	—	
Others	b086	Frequency conversion coefficient 0.1 to 99.9	1.0	Yes	—	
	b087	STOP key selection 00: Enabled 01: Disabled	00	No	—	
	b088	Free-run stop selection 00: 0 Hz start 01: Frequency pull-in restart	00	No	—	
	b090	Usage rate of regenerative braking function 0.0 to 100.0	0.0	No	%	
	b091	Stop selection 00: Deceleration → Stop 01: Free-run stop	00	No	—	
	b092	Cooling fan control 00: Always ON 01: ON during RUN 02: Depends on the fin temperature	01	No	—	
	b095	Regenerative braking function operation selection 00: Disabled 01: Enable (Disable during stop) 02: Enable (Enable during stop)	0.0	No	—	
	b096	Regenerative braking function ON level 200-V class: 330 to 380 400-V class: 660 to 760	200-V class: 360 V 400-V class: 720 V	No	V	
	b130	Overvoltage LAD stop function 00: Disabled 01: Enabled	00	No	—	
	b131	Overvoltage LAD stop function level setting 200-V class: 330. to 395. 400-V class: 660. to 790.	200-V class: 380 V 400-V class: 760 V	Yes	V	
	b140	Overcurrent suppression function 00: Disabled 01: Enabled	00	No	—	
	b150	Automatic carrier reduction 00: Disabled 01: Enabled	00	No	—	
	b151	Ready function selection 00: Disabled 01: Enabled	00	No	—	

*2nd control is displayed when '08 (2nd control)' is allocated to one of multi-function inputs from C001 to C006.

Parameter No.	Function name	Monitor or data range (Digital Operator)	Default setting	Changes during operation	Unit	Set value
Multi-function input terminals	C001	Multi-function input 1 selection	00: FW (forward) 01: RV (reverse)	No	—	
	C201	*2nd multi-function input 1 selection	02: CF1 (multi-step speed binary 1) 03: CF2 (multi-step speed binary 2) 04: CF3 (multi-step speed binary 3)			
	C002	Multi-function input 2 selection	05: CF4 (multi-step speed binary 4) 06: JG (jogging) 07: DB (external DC injection braking)			
	C202	*2nd multi-function input 2 selection	08: SET (2nd control) 09: 2CH (2-step acceleration/deceleration)			
	C003	Multi-function input 3 selection	11: FRS (free-run stop) 12: EXT (external trip) 13: USP (USP function)			
	C203	*2nd multi-function input 3 selection	15: SFT (soft lock) 16: AT (analog input switching) 18: RS (reset)			
	C004	Multi-function input 4 selection	19: PTC (thermistor input) 20: STA (3-wire start)			
	C204	*2nd multi-function input 4 selection	21: STP (3-wire stop) 22: F/R (3-wire forward/reverse) 23: PID (PID enabled/disabled)			
	C005	Multi-function input 5 selection	24: PIDC (PID integral reset) 27: UP (UP/DWN function accelerated)			
	C205	*2nd multi-function input 5 selection	28: DWN (UP/DWN function decelerated) 29: UDC (UP/DWN function data clear) 31: OPE (forced operator)			
	C006	Multi-function input 6 selection	50: ADD (frequency addition) 51: F-TM (forced terminal block)			
	C206	*2nd multi-function input 6 selection	52: RDY (ready function) 53: SP-SET (special setting) 255: No function			
C011	Multi-function input 1 operation selection	00: NO 01: NC	00	No	—	
C012	Multi-function input 2 operation selection		00			
C013	Multi-function input 3 operation selection		00			
C014	Multi-function input 4 operation selection		00			
C015	Multi-function input 5 operation selection		00			
C016	Multi-function input 6 operation selection		00			

*2nd control is displayed when '08 (2nd control)' is allocated to one of multi-function inputs from C001 to C006.

Appendix-1 Parameter List

Parameter No.	Function name	Monitor or data range (Digital Operator)	Default setting	Changes during operation	Unit	Set value	
Multi-function output setting	C021	Multi-function output terminal P1 selection	00	No	—		
	C022	Multi-function output terminal P2 selection	01				
	C026	Relay output (MA, MB) function selection	05				
	C028	AM selection	00: Output frequency 01: Output current	00	No	—	
	C031	Multi-function output terminal P1 contact selection	00: NO contact at MA; NC contact at MB 01: NC contact at MA; NO contact at MB	00	No	—	
	C032	Multi-function output terminal P2 contact selection		00			
	C036	Relay output (MA, MB) contact selection		01			
Level output status setting	C041	Overload warning level	Rated current	No	A		
	C241	*2nd overload warning level	Rated current				
	C042	Arrival frequency during acceleration	0.0 to 400.0	0.0	No	Hz	
	C043	Arrival frequency during deceleration	0.0 to 400.0	0.0	No	Hz	
	C044	PID deviation excessive level	0.0 to 100.0	3.0	No	%	
	C052	PID FB upper limit	0.0 to 100.0	100.0	No	%	
	C053	PID FB lower limit		0.0			

*2nd control is displayed when '08 (2nd control)' is allocated to one of multi-function inputs from C001 to C006.

Parameter No.	Function name	Monitor or data range (Digital Operator)	Default setting	Changes during operation	Unit	Set value
Communication function adjustment	C071	Communication speed selection (Baud rate selection)	04: 4800 bps 05: 9600 bps 06: 19200 bps	04	No	—
	C072	Communication station No. selection	1. to 32.	1.	No	—
	C074	Communication parity selection	00: No parity 01: Even 02: Odd	00	No	—
	C075	Communication stop bit selection	1: 1 bit 2: 2 bits	1	No	—
	C076	Communication error selection	00: Trip 01: Trip after deceleration stop 02: Ignore 03: Free run 04: Deceleration stop	02	No	—
	C077	Communication error timeout	0.00 to 99.99	0.00	No	s
	C078	Communication wait time	0. to 1000.	0	No	ms
	Various adjustment	C081	FV adjustment	0.0 to 200.0	100.0	Yes
C082		FI adjustment	0.0 to 200.0	100.0	Yes	%
C085		Thermistor adjustment	0.0 to 200.0 (For the external thermistor gain adjustment)	100.0	Yes	%
C086		AM offset adjustment	0.0 to 10.0	0.0	Yes	V

*2nd control is displayed when '08 (2nd control)' is allocated to one of multi-function inputs from C001 to C006.

Appendix-1 Parameter List

Parameter No.	Function name	Monitor or data range (Digital Operator)	Default setting	Changes during operation	Unit	Set value
Others	C091	Not used	Use "00". * Do not change.	00	—	—
	C101	UP/DWN selection	00: Do not store the frequency data 01: Store the frequency data	00	No	—
	C102	Reset selection	00: Trip reset at power-on 01: Trip reset when the power is OFF 02: Enabled only during trip (Reset when the power is ON.)	00	No	—
	C141	Logic operation function A input	00: RUN (signal during RUN) 01: FA1 (constant speed arrival signal) 02: FA2 (over set frequency arrival signal) 03: OL (overload warning) 04: OD (excessive PID deviation)	00	No	—
	C142	Logic operation function B input	05: AL (alarm output) 06: Dc (disconnection detected) 07: FBV (PID FB value fault) 08: NDc (network error)	01	No	—
	C143	Logic operator selection	00: AND 01: OR 02: XOR	00	No	—
	C144	Output terminal P1 ON delay	0.0 to 100.0	0.0	No	s
	C145	Output terminal P1 OFF delay	0.0 to 100.0	0.0	No	s
	C146	Output terminal P2 ON delay	0.0 to 100.0	0.0	No	s
	C147	Output terminal P2 OFF delay	0.0 to 100.0	0.0	No	s
	C148	Relay output ON delay	0.0 to 100.0	0.0	No	s
C149	Relay output OFF delay	0.0 to 100.0	0.0	No	s	

*2nd control is displayed when '08 (2nd control)' is allocated to one of multi-function inputs from C001 to C006.

Parameter No.	Function name	Monitor or data range (Digital Operator)	Default setting	Changes during operation	Unit	Set value
Control parameter	H003	Motor capacity selection	Factory default	No	kW	
	H203	*2nd motor capacity selection	Factory default			
	H004	Motor pole number selection	2 4 6 8	4	No	Pole
	H204	*2nd motor pole number selection	4			
	H006	Stabilization parameter	0. to 255.	100	Yes	%
	H206	* 2nd stabilization parameter		100		
	H007	Motor voltage selection	00: 200 V 01: 400 V	Factory default	Yes	%
	H207	*2nd motor voltage selection		Factory default		

*2nd control is displayed when '08 (2nd control)' is allocated to one of multi-function inputs from C001 to C006.

Appendix-2 Product Life Curve

Life of the Inverter smoothing capacitor

Ambient temperature refers to the surrounding temperature of the Inverter. The following diagram shows the product life curve.

The smoothing capacitor, which will waste because of the chemical reaction caused by parts temperatures, should normally be replaced once every 5 years. However, if the ambient temperature is high, or the Inverter is used with its rated current exceeded, for example, under overload conditions, its life will be significantly shortened.

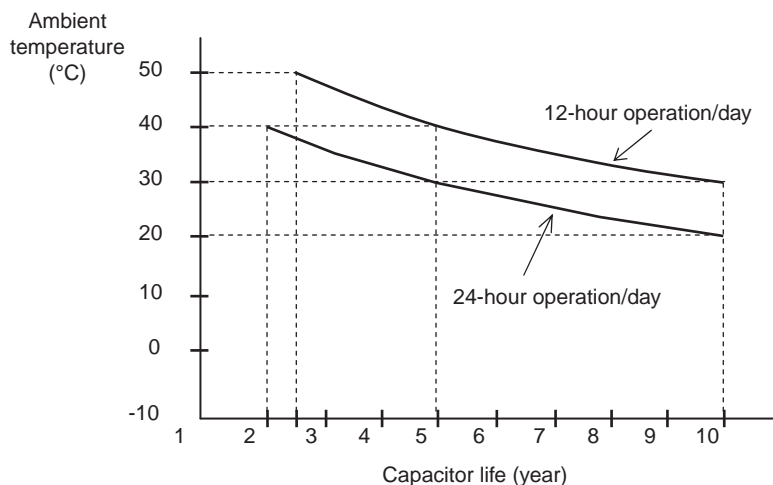

Note: Ambient temperature refers to the surrounding (atmospheric) temperature of the Inverter, or the temperature inside if the Inverter is encased or installed in an enclosure.

INDEX

Index

Numerics

2CH	4-22
2nd control function and special 2nd function	4-44
2-step acceleration/deceleration function	4-22
3-wire input function	4-49

A

acceleration time 2	4-22
acceleration/deceleration pattern	4-23
ADD	4-51
AL	4-57
alarm output	4-57
allowable momentary power interruption time	4-25
AM	4-63
analog input	4-10
automatic carrier frequency reduction function	4-39

B

base frequency	4-8
----------------------	-----

C

carrier frequency	4-32
communication function	4-65
constant torque characteristics	4-12
cooling fan control	4-36

D

DB	4-14
Dc	4-57
DC injection braking	4-14
deceleration time 2	4-22
DWN	4-50

E

electronic thermal function	4-27
end frequency	4-10
external DC injection braking	4-15
external trip	4-46

F

F/R	4-49
fault frequency monitor	4-3
fault monitor	4-3
FBV	4-59
forced operator function	4-51
forced terminal block	4-52

free-run stop (FRS) selection and stop selection	4-35
frequency addition (ADD)	4-51
frequency arrival signal	4-54
frequency conversion coefficient	4-35
frequency conversion monitor	4-2
frequency jump function	4-18
frequency limit	4-17
lower limit	4-17
upper limit	4-17
frequency reference selection	4-7
F-TM	4-52
FV	4-10
FV, FI sampling	4-11

I

internal DC injection braking	4-16
-------------------------------------	------

J

JG	4-43
jogging operation	4-43

L

LOG	4-60
logic operation output (LOG)	4-60

M

maximum frequency	4-9
momentary power interruption/trip retry	4-25
momentary power interruption/undervoltage trip during stop selection	4-25
multi-function input monitor	4-2
multi-function input selection	4-40
multi-function output contact selection	4-61
multi-function output monitor	4-2
multi-function output selection	4-53
multi-step speed operation function	4-42

N

NDc	4-59
NO/NC contact	4-61

O

OD	4-56
OL	4-55
OPE	4-51
output current monitor	4-1
output frequency monitor	4-1

output frequency setting/monitor	4-5
output voltage gain	4-14
output voltage monitor	4-3
overcurrent suppression function	4-39
overload limit	4-29
overload warning	4-30, 4-55

P

parameter initialization	4-32
PID feedback value monitor	4-1
PID function	4-18
PIDC	4-20
power ON time monitor	4-3
power recovery restart prevention function	4-47
PTC	4-48

R

RDY	4-52
RDY (ready) function	4-40
regenerative braking function	4-37
relation between torque boost and V/f characteristics	4-11
relay output terminal	4-53
reset	4-48
retry selection	4-25
rotation (RUN) direction monitor	4-1
rotation (RUN) direction selection	4-6
RS	4-48
RUN	4-54
RUN command selection	4-8

S

SET	4-44
SFT	4-47
signal during RUN	4-54
soft lock	4-47
soft lock function	4-30
special reduced torque characteristics	4-12
SP-SET	4-44
STA	4-49
stabilization parameter	4-34, 4-64
start frequency	4-10
starting frequency	4-31
STOP key selection	4-35
stop selection	4-35
STP	4-49

T

thermistor trip function	4-48
torque boost	4-13
total RUN time	4-3

U

UDC	4-50
UP	4-50
UP/DOWN function	4-50
USP	4-47

OMRON Corporation
Industrial Automation Company
Control Devices Division H.Q.
Motion Control Division

Shiokoji Horikawa, Shimogyo-ku,
Kyoto, 600-8530 Japan
Tel: (81) 75-344-7173/Fax: (81) 75-344-7149
2-2-1 Nishikusatsu, Kusatsu-shi,
Shiga, 525-0035 Japan
Tel: (81) 77-565-5223/Fax: (81) 77-565-5568

Regional Headquarters

OMRON EUROPE B.V.
Wegalaan 67-69-2132 JD Hoofddorp
The Netherlands
Tel: (31)2356-81-300/Fax: (31)2356-81-388

OMRON Industrial Automation Global: www.ia.omron.com

OMRON ELECTRONICS LLC

One Commerce Drive Schaumburg,
IL 60173-5302 U.S.A.
Tel: (1) 847-843-7900/Fax: (1) 847-843-7787

OMRON ASIA PACIFIC PTE. LTD.

No. 438A Alexandra Road # 05-05/08 (Lobby 2),
Alexandra Technopark, Singapore 119967
Tel: (65) 6835-3011/Fax: (65) 6835-2711

OMRON (CHINA) CO., LTD.

Room 2211, Bank of China Tower,
200 Yin Cheng Zhong Road,
PuDong New Area, Shanghai, 200120, China
Tel: (86) 21-5037-2222/Fax: (86) 21-5037-2200

Authorized Distributor:

© OMRON Corporation 2007 All Rights Reserved.
In the interest of product improvement,
specifications are subject to change without notice.

Cat. No. I559-E1-02