

5

4

3

2

1

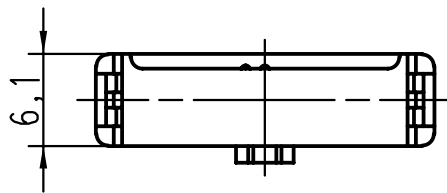
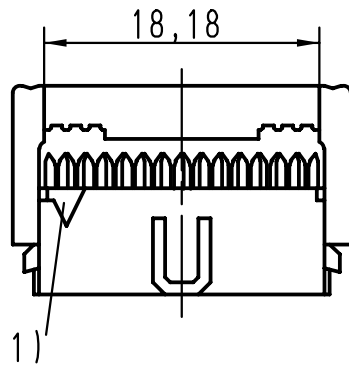
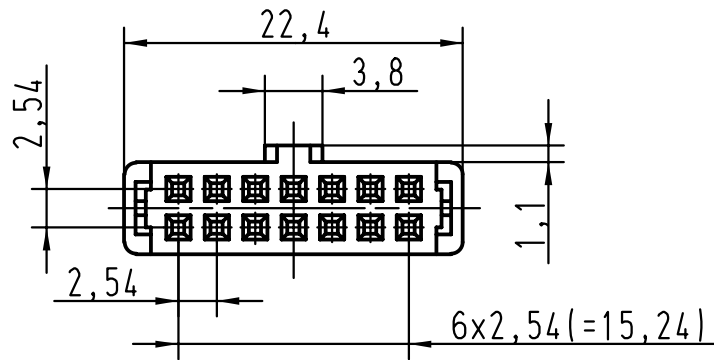

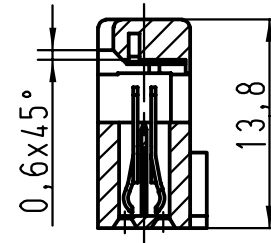

vorverrastet  
pre assembled  
preassemble

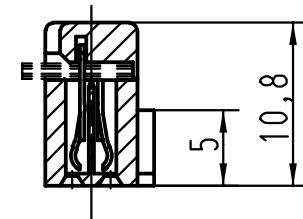

verrastet  
fitted  
assemble



- 1) Markierung erster Kontakt, Ader 1 des Flachkabels  
 1) Contact no.1, 1st wire of flat cable  
 1) Contact no.1, repère 1 du câble

		 All Dimensions in mm Original Size DIN A 4		Techn. Character.			Nicht tolerierte Masse/ Free size tolerances							
								SEK 18 Female Connector 14 poles with central polarisation cover with cable stop						
09185145804		0,76 $\mu\text{m}$ Au				Detail.					Dat.	Name	Massstab/Scale  2:1	
09185146804		2				Insp.					01-FEB-00	JMV		
09185147804		3				Stand.								
Bestell-Nr. Part-No. Reference		Anforderungsstufe performance level Niveau de qualite		26570		01-FEB-00		JB		HARTING EURL F-95972 Paris		 TB 0918514X804		Blatt/ page 1 / 1
				Mod.		Dat.		Name						