

0RQB-C2Q12x

Isolated DC-DC Converter

The 0RQB-C2Q12x is an isolated dc/dc converter that operates from a nominal 24 VDC source. This unit will provide up to 156 W of output power from a nominal 24 VDC input.

This unit is designed to be highly efficient and low cost. Features include remote on/off, over current protection and overvoltage protection.

The converter is provided in an industry standard quarter brick package.

Key Features & Benefits

- 9-36 VDC Input
- 12 VDC @ 13 A Output
- 1/4th Brick Converter
- Fixed Frequency
- High Efficiency
- High Power Density
- Low cost
- Input Under Voltage Lockout
- Input over voltage lockout
- OCP/SCP
- Output Over-voltage Protection
- Over Temperature Protection
- Remote On/Off
- Baseplate
- Basic Isolation
- Approved to UL/CSA 60950-1, 2nd +A2 version(TBD)
- Class II, Category 2, Isolated DC/DC Converter (refer to IPC-9592B)



Applications

- Networking
- Computers and peripherals
- Telecommunications



bel POWER
SOLUTIONS &
PROTECTION

a bel group

belfuse.com/power-solutions

1. MODEL SELECTION

MODEL NUMBER	OUTPUT VOLTAGE	INPUT VOLTAGE	MAX. OUTPUT CURRENT	MAX. OUTPUT POWER	TYPICAL EFFICIENCY
0RQB-C2Q120	12 VDC	9-36 VDC	13A	156 W	94%
0RQB-C2Q12L	12 VDC	9-36 VDC	13A	156 W	94%

NOTE: Add “G” suffix at the end of the model number to indicate Tray Packaging.

PART NUMBER EXPLANATION

0	R	QB	-	C2	Q	12	x	y
Mounting Type	RoHS Status	Series Name		Output Power	Input Range	Output Voltage	Active Logic	Package Type
Through hole mount	RoHS	1/4th Brick		156 W	9-36V	12 V	L – active low, without HSK 0 – active High , without HSK	G – Tray package

2. ABSOLUTE MAXIMUM RATINGS

PARAMETER	DESCRIPTION	MIN	TYP	MAX	UNITS
Continuous non-operating Input Voltage		-0.3	-	36	V
Input Transient Voltage	100ms maximum	-	-	50	V
Input withstand Voltage	1min maximum, the module may turn off, but will survive without damage.	-	-	48	V
Remote On/Off		-0.3	-	18	V
I/O isolation voltage		-	-	1500	V
Ambient temperature		-40	-	85	°C
Storage Temperature		-55	-	125	°C
Relative humidity range		10	-	90	%
Altitude		-	-	2000	m

NOTE: Ratings used beyond the maximum ratings may cause a reliability degradation of the converter or may permanently damage the device.

3. INPUT SPECIFICATIONS

PARAMETER	DESCRIPTION	MIN	TYP	MAX	UNIT
Operating Input Voltage		9	24	36	V
Input Current (full load)	Test at 9V input voltage	-	-	20.0	A
Input Current (no load)		-	200	240	mA
Remote Off Input Current		-	25	35	mA
Input Reflected Ripple Current (rms)	With simulated source impedance of 10 μ H, 5Hz to 20MHz. Use a 2*220 μ F/100V electrolytic capacitor with ESR=1 ohm max, at 200KHz@25°C.	-	5	10	mA
Input Reflected Ripple Current (pk-pk)		-	30	40	mA
I ² t Inrush Current Transient		-	0.05	0.1	A ² s
Turn-on Voltage Threshold		9.5	10	10.5	V
Turn-off Voltage Threshold		7.5	8	8.5	V
OTHER INFORMATION:					
Input capacitance	4*4.7 μ F/50V ceramic capacitor		18.8		μ F

NOTE: All specifications are typical at 25°C unless otherwise stated

CAUTION: This converter is not internally fused. An input line fuse must be used in application. Recommend a input fast-acting fuse with Typical of 30A on system board. Refer to the fuse manufacture’s datasheet for further information.

4. OUTPUT SPECIFICATIONS

All specifications are typical at nominal input, full load at 25°C unless otherwise stated.

PARAMETER	DESCRIPTION	MIN	TYP	MAX	UNIT
Output Voltage Set Point	Vin=24 V, Io=50% load at 25°C ambient.	11.8	12.04	12.28	V
Load Regulation	Vin=24V, Io=0~100% load at 25°C ambient.	-	±15	±30	mV
Line Regulation		-	±15	±30	mV
Regulation Over Temperature		-	±100	±200	mV
Output Ripple and Noise(Pk-Pk)	Vin=24V ,Full load ,0-20MHz BW, with a 1µF ceramic capacitor and a 10µF Tantalum cap and 220µF Tantalum cap at output.	-	100	150	mV
Output Ripple and Noise(RMS)		-	25	40	mV
Output Current Range	The 0RQB-C2Q12x module can start up with 17A for 100ms at Vin>12V.	0	-	13	A
Output DC Current Limit		15	20	25	A
Short Circuit Surge Transient		-	-	5	A²s
Rise time		-	12	20	ms
Turn on Time	Ton(Enable form Vin)	-	30	40	ms
	Ton(Enable form ON/OFF)	-	30	40	ms
Overshoot at Turn on		0	-	3	%
Output Capacitance	Note: The minimum output capacitance(220µF) must be low ESR capacitance, such as Tantalum capacitance or POSCAP, and the total ESR must bigger than 3mΩ .	220	-	5000	µF
Transient Response					
ΔV 50%~75% of Max Load		-	400	500	mV
Settling Time	di/dt=0.1A/µs, Vin=24VDC, Ta=25°C, with a 1µF ceramic capacitor, a 10µF Tantalum cap and 220µF Tantalum cap at output.	-	200	300	µs
ΔV 75%~50% of Max Load		-	400	500	mV
Settling Time		-	200	300	µs

NOTE: All specifications are typical at nominal input, full load at 25°C unless otherwise stated.

5. GENERAL SPECIFICATIONS

PARAMETER	DESCRIPTION	MIN	TYP	MAX	UNIT
Efficiency	$V_{in}=24\text{ V}$ $I_o=I_o, \text{ max}$ The efficiency is measured at $V_{in}=24\text{V}$, full load and $T_a=25^\circ\text{C}$.	92	94	-	%
Switching Frequency		-	200	-	kHz
Over Temperature Protection		-	125	130	$^\circ\text{C}$
Over Voltage Protection(Static)	This voltage is achieved by trimming up output slowly.		15.3	15.8	V
FIT	Calculated Per Bell Core SR-332 ($V_{in}=24\text{ V}$, $V_o=12\text{ V}$, $I_o=10.4\text{ A}$, $T_a=58^\circ\text{C}$, $\text{FIT}=10^9/\text{MTBF}$)	-	546	-	-
Weight		-	64	-	g
Dimensions (L x W x H)		2.30 x 1.45 x 0.50 58.42 x 36.83 x 12.68			inch mm
ISOLATION CHARACTERISTICS					
Input to Output		-	-	1500	V
Input to Case		-	-	1500	V
Output to Case		-	-	500	V
Isolation Resistance		10M	-	-	Ohm
Isolation Capacitance		-	3900	-	pF

6. EFFICIENCY DATA

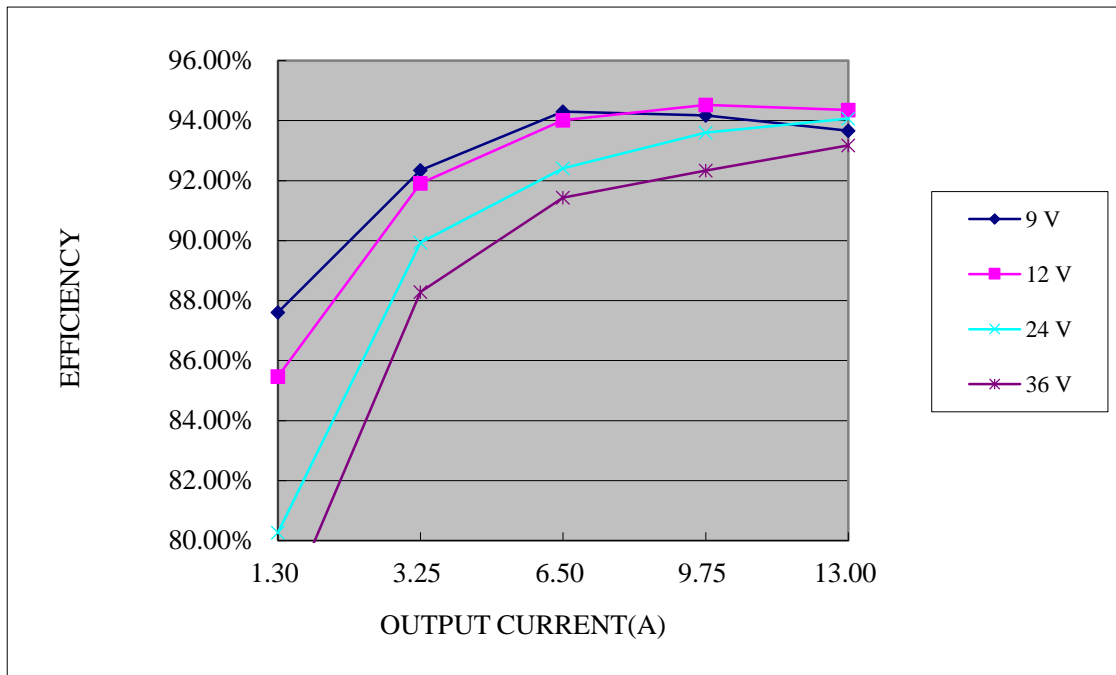

7. THERMAL DERATING CURVE

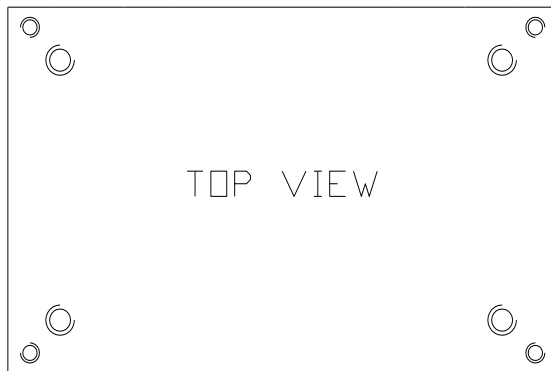

↑
Forced Airflow Direction

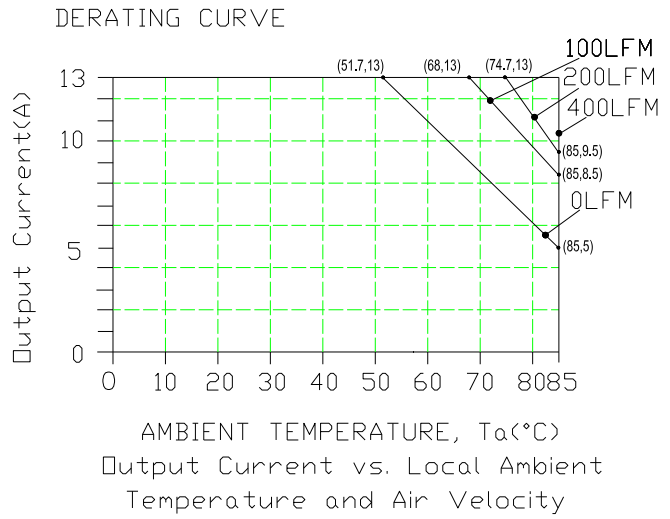

Vin=24V
Derating curve under normal input

8. RIPPLE AND NOISE WAVEFORM

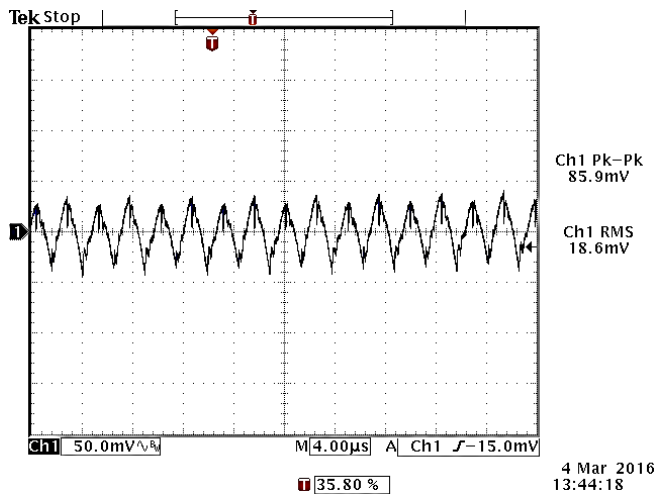

Ripple and noise at full load, 24VDC input, 12VDC/13A output and Ta=25 °C, and with a 1µF ceramic cap and a 10 uF Tantalum cap and 220µF Tantalum cap at output.

9. TRANSIENT RESPONSE WAVEFORMS

$di/dt=0.1A/\mu S$, a $1\mu F$ ceramic capacitor, a $10\mu F$ Tantalum cap and $220\mu F$ Tantalum cap at output.

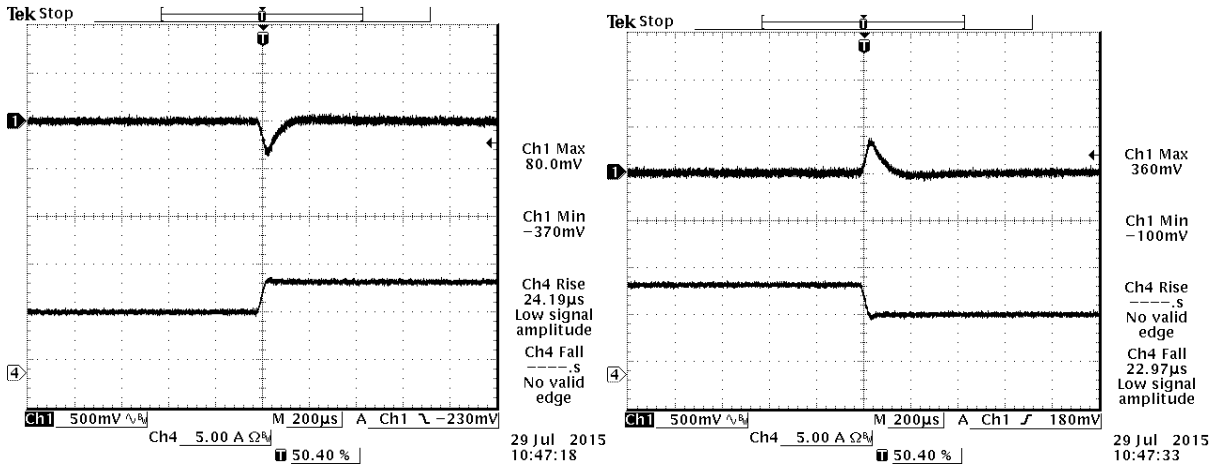

CH1=Vout
 CH4=lout
 Vout= 12V 50%-75% Load Transients
 at Vin=24V@Ta=25°C

CH1=Vout
 CH4=lout
 Vout= 12V 75%-50% Load Transients
 at Vin=24V@Ta=25°C

10. STARTUP&SHUTDOWN

RISE TIME

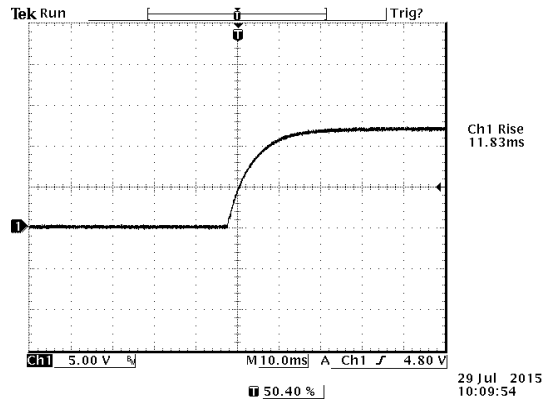

Vin = 24 V, Full Load

STARTUP TIME

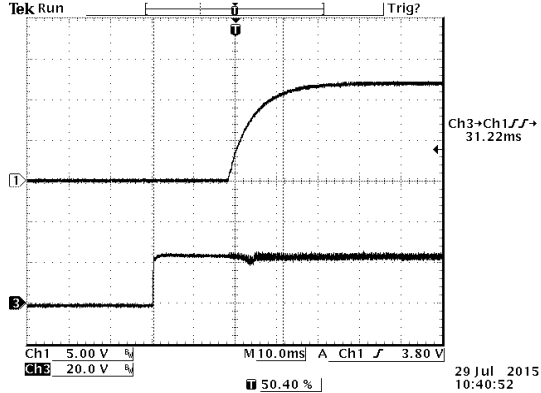

CH1=Vout
CH3=Vin
Vin = 24 V, Full Load
startup from Vin

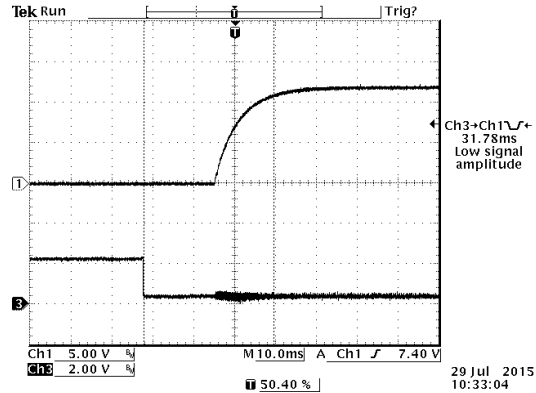

CH1=Vout
CH3=Enable
Vin = 24 V, Full Load
startup from Enable

Shutdown

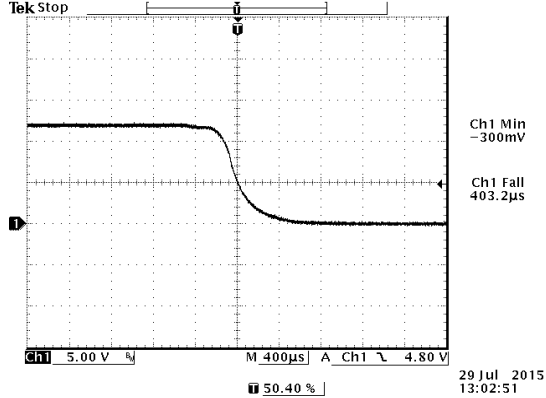

Vin = 24 V, Full Load
shutdown from Vin

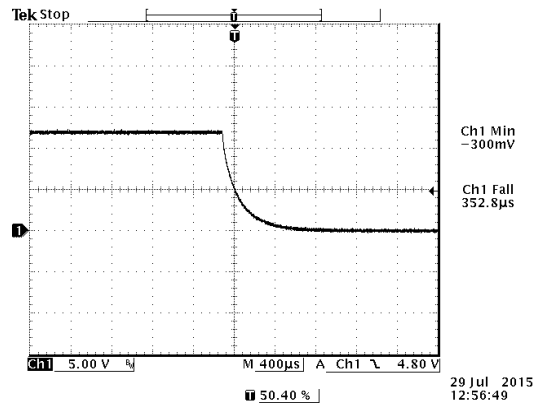

Vin = 24 V, Full Load
shutdown from Enable

11. REMOTE ON/OFF

PARAMETER	DESCRIPTION	MIN	TYP	MAX	UNIT
Signal Low (Unit On)	Active Low	-0.3	-	0.8	V
Signal High (Unit Off)	Active High	2.4	-	18	V
Signal Low (Unit Off)	Active Low	-0.3	-	0.8	V
Signal High (Unit On)	Active High	2.4	-	18	V
Current Sink		0	-	1	mA

Recommended remote on/off circuit for active low

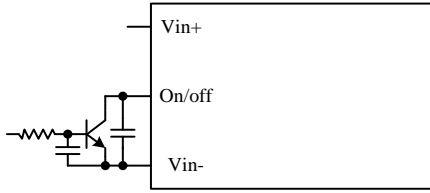

Control with open collector/drain circuit

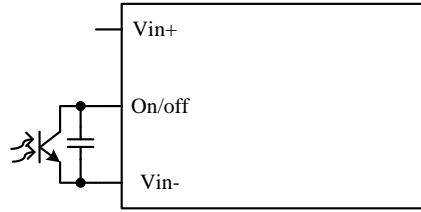

Control with photocoupler circuit

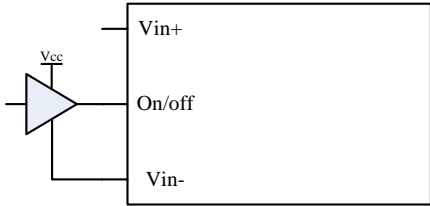

Control with logic circuit

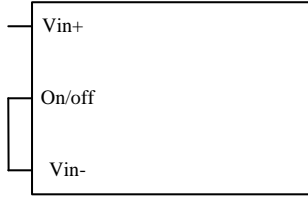

Permanently on

Recommended remote on/off circuit for active high

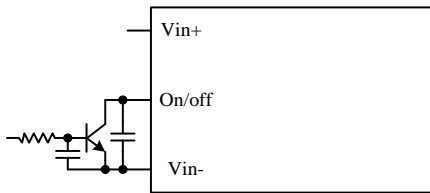

Control with open collector/drain circuit

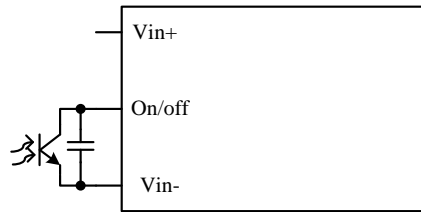

Control with photocoupler circuit

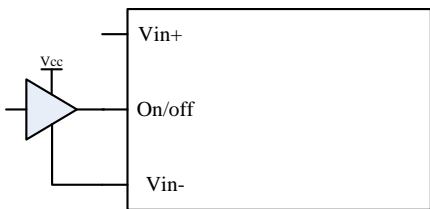

Control with logic circuit

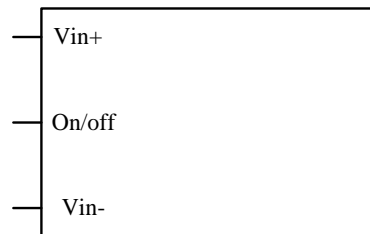

Permanently on

12. OUTPUT TRIM EQUATIONS

Equations for calculating the trim resistor are shown below. The Trim Down resistor should be connected between the Trim pin and Sense (-) pin. The Trim Up resistor should be connected between the Trim pin and the Sense (+). Only one of the resistors should be used for any given application.

Minimum trim down voltage is 10.8V

Maximum trim up voltage is 13.2V.

The total voltage increased by trim and remote sense should not exceed 10% of the nominal output voltage.

Trim down test circuit

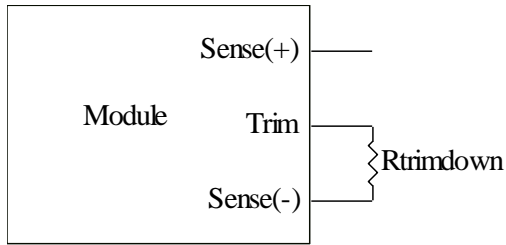

$$R_{trimdown} = \frac{511}{|\delta|} - 10.22 [k\Omega]$$

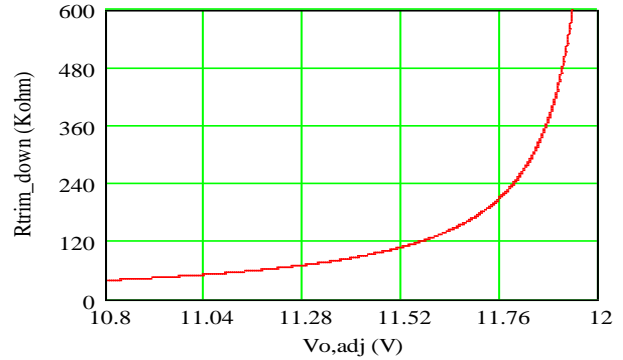

Trim up test circuit

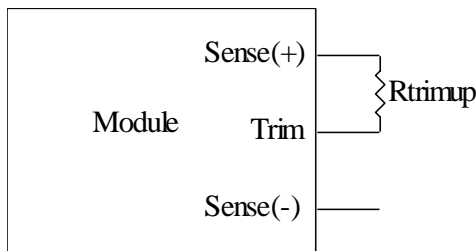

$$R_{trimup} = \frac{(100 + \delta) \cdot V_o \cdot 5.11 - 626}{1.225 \cdot \delta} - 10.22 [k\Omega]$$

$$\delta = \frac{(V_o_{req} - V_o)}{V_o} \times 100 [\%]$$

NOTE: Output voltage $V_o = 12.036V$

V_o_{req} = Desired(trimmed) output voltage[V]

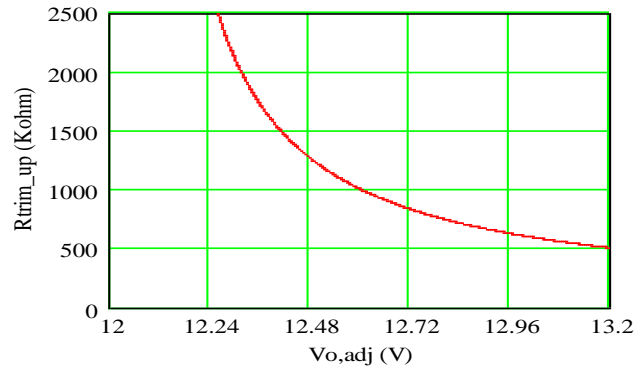

13. REMOTE SENSE

This module has remote sense compensation feature. It can minimize the effects of resistance between module's output and load in system layout and facilitates accurate voltage regulation at load terminals or other selected point.

The remote sense lines carry very little current and hence do not require a large cross-sectional area.

This module compensates for a maximum drop of 10% of the nominal output voltage.

If the unit is already trimmed up, the available remote sense compensation range should be correspondingly reduced. The total voltage increased by trim and remote sense should not exceed 10% of the nominal output voltage.

When using remote sense compensation, all the resistance, parasitic inductance and capacitance of the system are incorporated within the feedback loop of this module. This can make an effect on the module's compensation, affecting the stability and dynamic response. A 0.1 μ F ceramic capacitor can be connected at the point of load to de-couple noise on the sense wires.

Recommend the connection of remote sense compensation as below figure. There are a resistor RS+ (30.1ohm) from Vo+ to Sense+ and a resistor RS- (30.1 ohm) from Vo- to Sense- inside of this module.

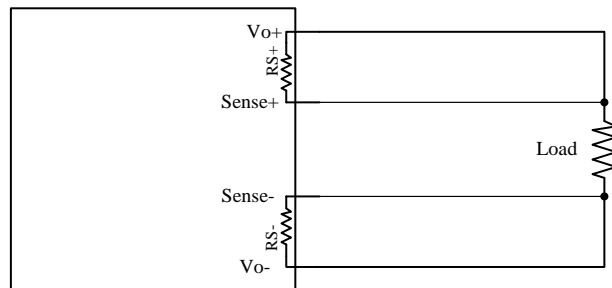

If not using remote sense compensation, please connect sense directly to output at module's pin, that is, connect sense+ to Vo+ and sense- to Vo- at module's pin, the shorter the better. see below figure.

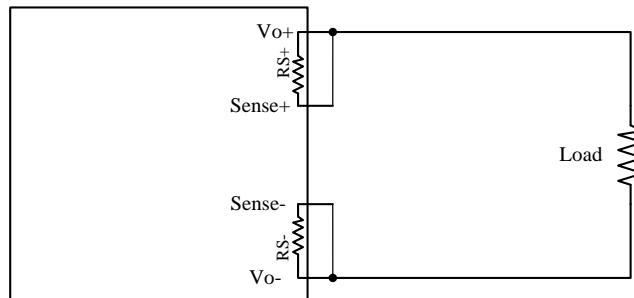

14. OVER CURRENT PROTECTION

To provide protection in a fault output overload condition, the module is equipped with internal current-limiting circuitry and can endure current limiting for a few milliseconds. If the overcurrent condition persists beyond a few milliseconds, the module will shut down into hiccup mode and restart once every 0.8S. The module operates normally when the output current goes into specified range. The typical average output current is 20A during hiccup.

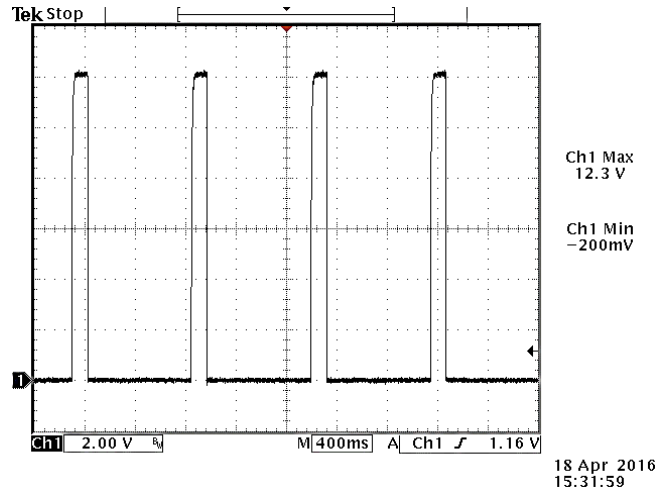

Vin = 24 V, Iout OCP

15. OUTPUT OVERVOLTAGE PROTECTION

The output overvoltage protection consists of circuitry that monitors the voltage on the output terminals. If the voltage on the output terminals exceeds the over voltage protection threshold, the module will shutdown into latch off mode. The overvoltage latch can be reset by either cycling the input power or toggling the on/off signal for one second at least.

TEST SETUP:

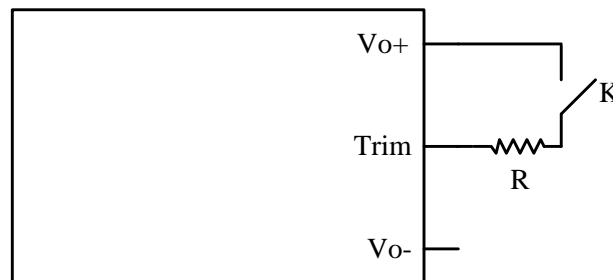

R=150KΩ

16. OTP

The OTP is achieved by thermistor RT and the threshold is set at 120°C in non-latch mode; the hottest component (bottom side) U7 reaches 115°C or the base plate (top side) reaches 110°C with 200LFM air flow correspondingly. It will restart automatically when the temperature falls down to 110°C. The protecting point will be varied a little under different conditions (air flow, ambient temperature, input voltage, load...).

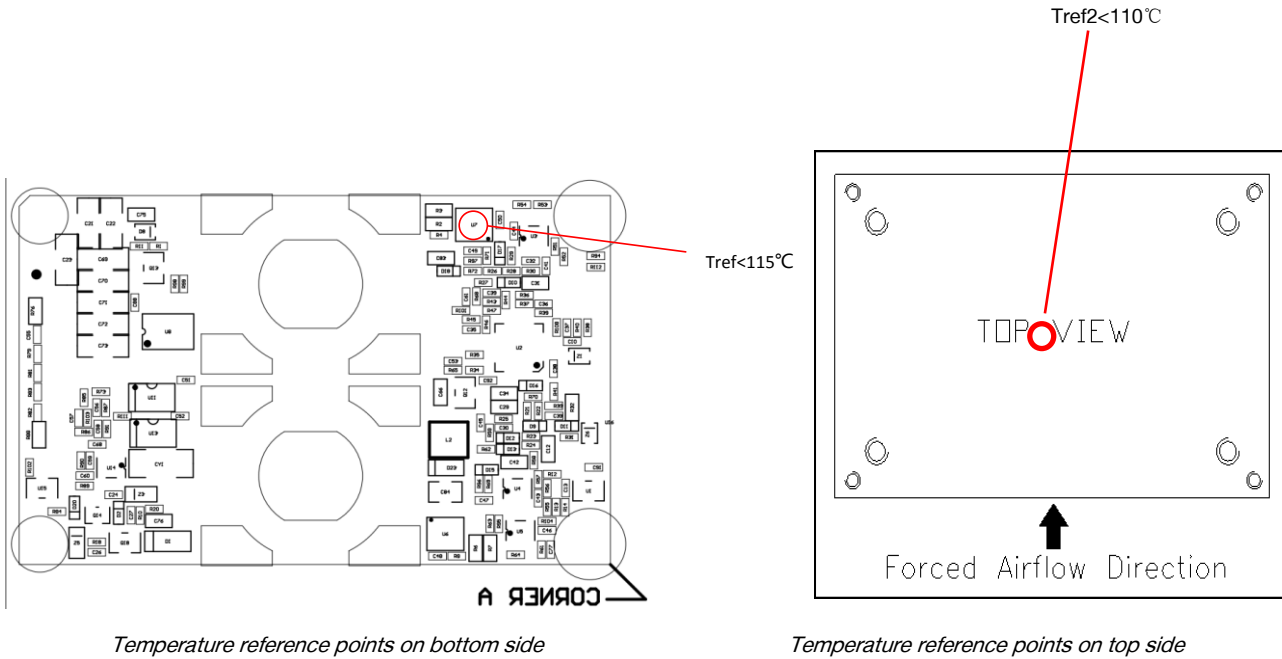

16. INPUT UNDER-VOLTAGE LOCKOUT

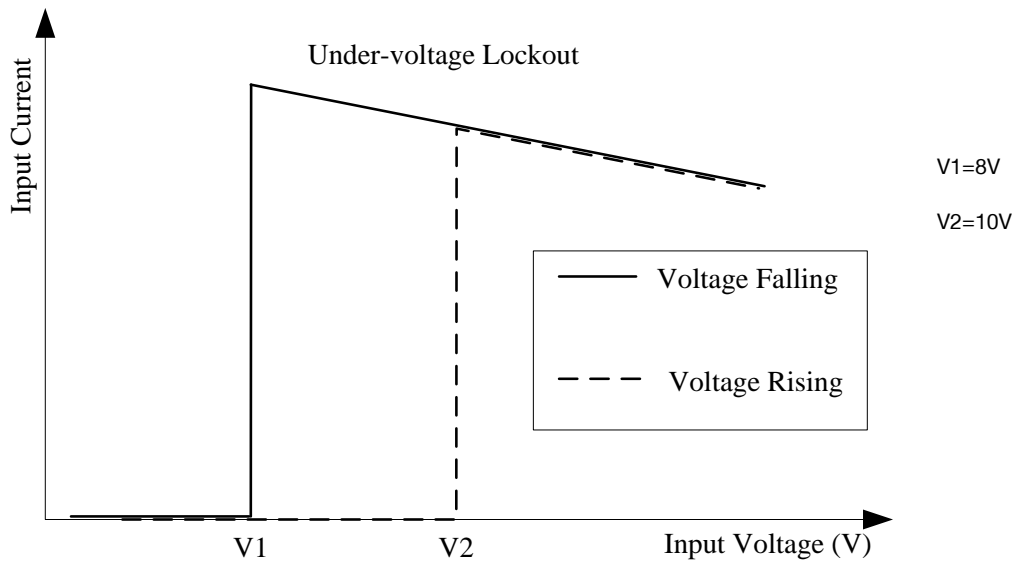

17. MECHANICAL DIMENSIONS

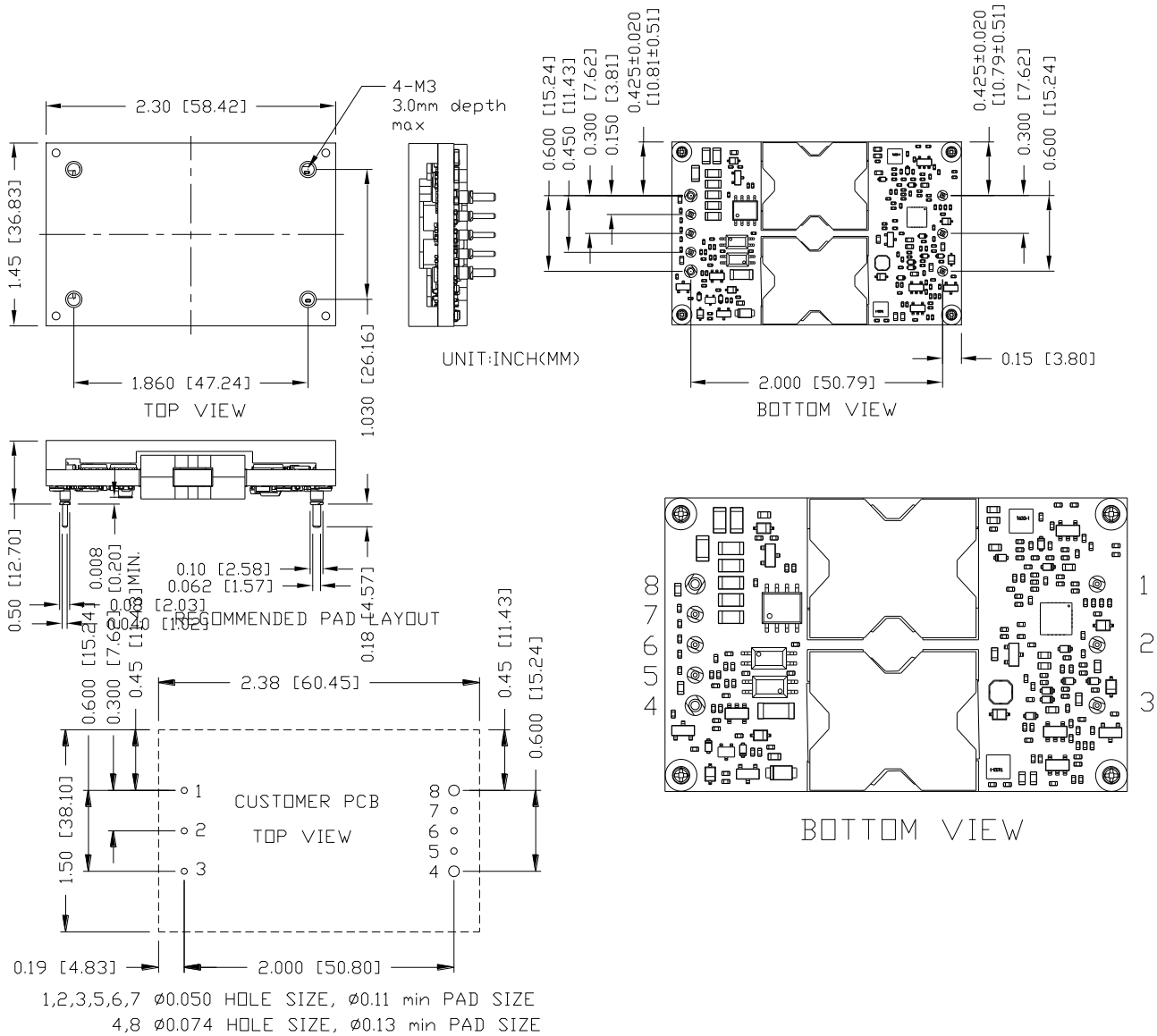

NOTE: This module is recommended and compatible with Pb-Free Wave Soldering and must be soldered using a peak solder temperature of no more than 260 °C for less than 5 seconds.

NOTES:

All Pins: Material - Copper Alloy;
 Finish – 3 micro inches minimum Gold over 50 micro inches minimum Nickel plate.

- 1) Undimensioned components are shown for visual reference only.
- 2) All dimensions in inches; Tolerances: x.xx +/-0.02 in [0.51 mm]. x.xxx +/-0.010 in [0.25 mm].

PIN CONNECTIONS

PIN	FUNCTION	PIN SIZE
1	Vin+	0.040"
2	On/Off	0.040"
3	Vin-	0.040"
4	Vout-	0.060"
5	Sense-	0.040"
6	Trim	0.040"
7	Sense+	0.040"
8	Vout+	0.060"



Asia-Pacific
 +86 755 298 85888

Europe, Middle East
 +353 61 225 977

North America
 +1 408 785 5200

18. SAFETY & EMC

SAFETY :

TBD

EMC:

1. Conductive EMI: EN55022 class B

Compliance to EN55022 class B (both peak and average) with the following inductive and capacitive filter.

SETUP:

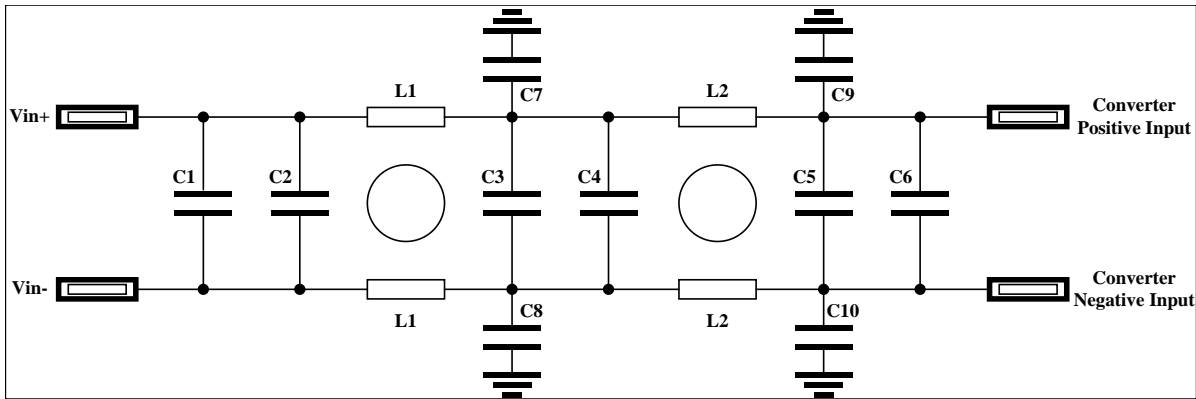

ITEM	DESIGNATION	PARAMETER	VEND	VENDOR P/N
1	C1	Chip CAP X7R 4.7µF +/-10% 50V 1210	MURA	GRM32ER71H475KA88L
2	C2	Chip CAP X7R 4.7µF +/-10% 50V 1210	MURA	GRM32ER71H475KA88L
3	C3	NOT USED		
4	C4	NOT USED		
5	C5	100µF/100V 105 10*20	Nichic	UVZ2A101MPD
6	C6	100µF/100V 105 10*20	Nichic	UVZ2A101MPD
7	C7	EMI Suppression Cap Y2 MKP 33nF+/-20% 300VAC	EPÇO	B32022A3333M289
8	C8	EMI Suppression Cap Y2 MKP 33nF+/-20% 300VAC	EPÇO	B32022A3333M289
9	C9	EMI Suppression Cap Y2 MKP 33nF+/-20% 300VAC	EPÇO	B32022A3333M289
10	C10	EMI Suppression Cap Y2 MKP 33nF+/-20% 300VAC	EPÇO	B32022A3333M289
11	L1	1.47mH/30A	core:	core: 40T0984-00H
12	L2	320µH/30A	core:	core: 40T0711-00H

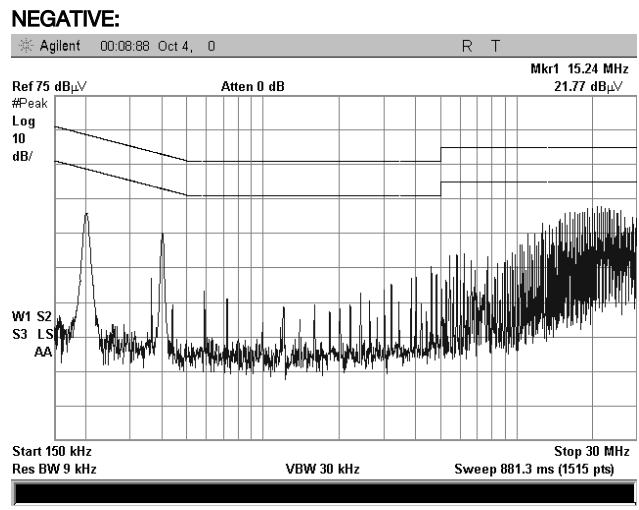
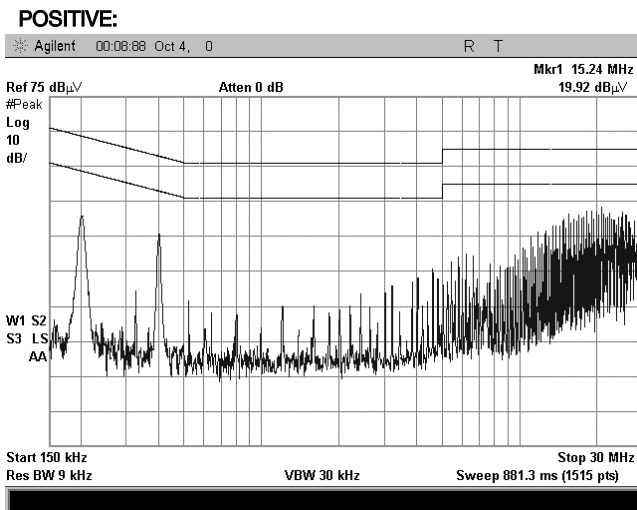

19. SCH FUNDAMENTAL CIRCUIT DIAGRAM

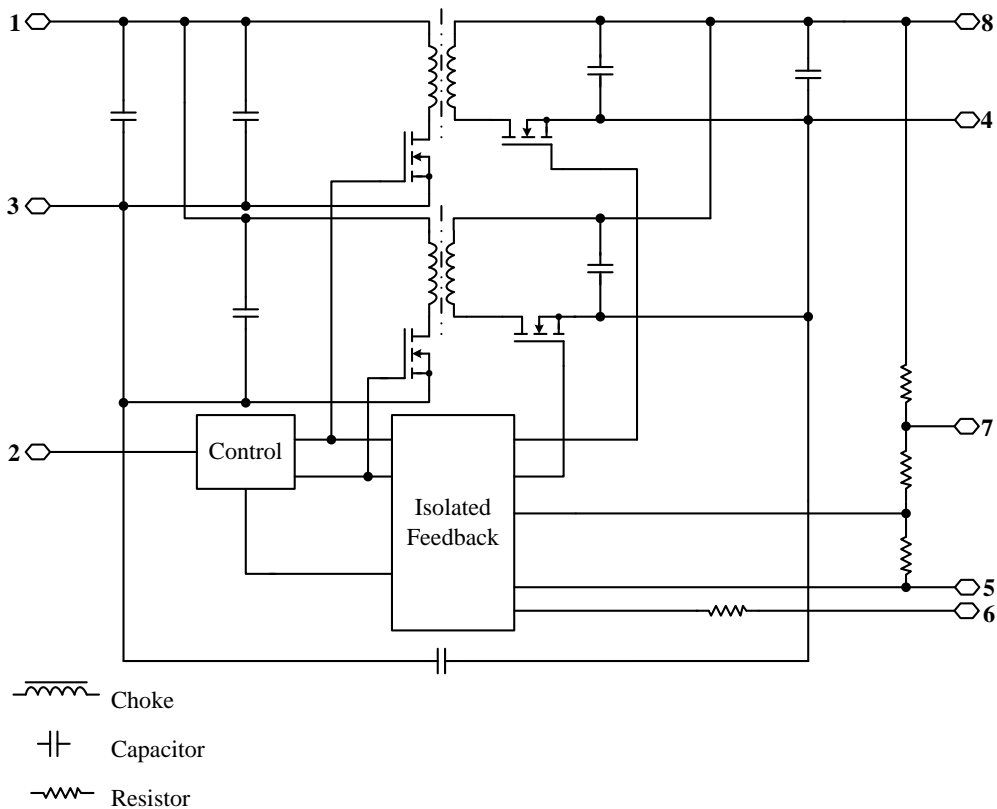

20. REVISION HISTORY

DATE	REVISION	CHANGES DETAIL	APPROVAL
2013-04-26	A	First revision	XF Jiang
2016-04-28	B	Update the remote off input current, output ripple and noise(pk-pk), output DC current limit, rise time, output capacitance, transient response settling time, efficiency, switching frequency, isolation capacitance, add efficiency data and layout, add the wave of NR, TR, startup & shutdown, OCP, MD, safety & EMC.	XF Jiang
2016-06-27	C	Update altitude, load regulation, output current range, output capacitance , FIT , weigh, TD, OTP, add the relative humidity range.	XF Jiang
2016-10-11	AD	Add temperature reference points on top side.	XF Jiang
2017-04-13	AE	Update TD	XF Jiang
2017-10-18	AF	Update Input withstand Voltage.	J Yao

For more information on these products consult: tech.support@psbel.com

NUCLEAR AND MEDICAL APPLICATIONS - Products are not designed or intended for use as critical components in life support systems, equipment used in hazardous environments, or nuclear control systems.

TECHNICAL REVISIONS - The appearance of products, including safety agency certifications pictured on labels, may change depending on the date manufactured. Specifications are subject to change without notice.