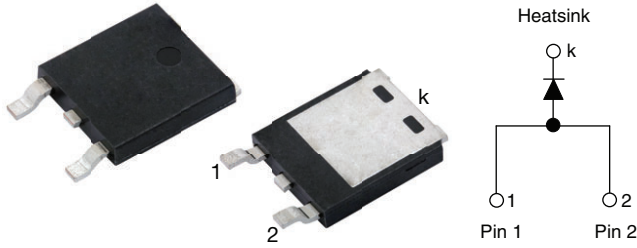

Hyperfast Rectifier, 8 A FRED Pt[®]

 eSMP[®] Series

SlimDPAK (TO-252AE)
FEATURES

- Hyperfast recovery time, extremely Q_{rr} recovery
- For PFC CCM operation
- Low forward voltage drop, low power losses
- Low leakage current
- Meets MSL level 1, per J-STD-020, LF maximum peak of 260 °C
- Meets JESD 201 class 2 whisker test
- Material categorization: for definitions of compliance please see www.vishay.com/doc?99912

RoHS
 COMPLIANT
 HALOGEN
FREE
TYPICAL APPLICATIONS

These devices are intended for use in PFC boost stage in the AC/DC section of SMPS inverters, or as freewheeling diodes. Their extremely optimized stored charge and low recovery current minimize the switching losses and reduce over dissipation in the switching element and snubbers.

MECHANICAL DATA
Case: SlimDPAK

Molding compound meets UL 94 V-0 flammability rating

Base PN/-M3 - halogen-free, RoHS-compliant

Terminals: matte tin plated leads, solderable per J-STD-002 and JESD 22-B102

PRODUCT SUMMARY

Package	SlimDPAK (TO-252AE)
$I_{F(AV)}$	8 A
V_R	600 V
V_F at I_F	1.4 V
t_{rr} (typ.)	14 ns
T_J max.	175 °C
Diode variation	Single

ABSOLUTE MAXIMUM RATINGS

PARAMETER	SYMBOL	TEST CONDITIONS	VALUES	UNITS
Peak repetitive reverse voltage	V_{RRM}		600	V
Average rectified forward current	$I_{F(AV)}$	$T_C = 140$ °C	8	A
Non-repetitive peak surge current	I_{FSM}	$T_J = 25$ °C	80	
Operating junction and storage temperatures	T_J, T_{Stg}		-55 to +175	°C

ELECTRICAL SPECIFICATIONS ($T_J = 25$ °C unless otherwise specified)

PARAMETER	SYMBOL	TEST CONDITIONS	MIN.	TYP.	MAX.	UNITS
Breakdown voltage, blocking voltage	V_{BR}, V_R	$I_R = 100$ μ A	600	-	-	V
		$I_F = 8$ A	-	2.3	3.0	
Forward voltage	V_F	$I_F = 8$ A, $T_J = 150$ °C	-	1.4	1.8	
		$V_R = V_R$ rated	-	-	20	
Reverse leakage current	I_R	$T_J = 150$ °C, $V_R = V_R$ rated	-	-	500	μ A
			-	12	-	pF
Junction capacitance	C_T	$V_R = 600$ V	-	12	-	pF



DYNAMIC RECOVERY CHARACTERISTICS (T _J = 25 °C unless otherwise specified)						
PARAMETER	SYMBOL	TEST CONDITIONS	MIN.	TYP.	MAX.	UNITS
Reverse recovery time	t _{rr}	I _F = 1 A, di _F /dt = 50 A/μs, V _R = 30 V	-	20	-	ns
		I _F = 1 A, di _F /dt = 100 A/μs, V _R = 30 V	-	14	-	
		I _F = 0.5 A, I _R = 1 A, I _{RR} = 0.25 A	-	-	18	
		T _J = 25 °C	-	20	-	
		T _J = 125 °C	-	54	-	
Peak recovery current	I _{RRM}	T _J = 25 °C	-	4.0	-	A
		T _J = 125 °C	-	8.0	-	
Reverse recovery charge	Q _{rr}	T _J = 25 °C	-	60	-	nC
		T _J = 125 °C	-	200	-	

THERMAL - MECHANICAL SPECIFICATIONS						
PARAMETER	SYMBOL	TEST CONDITIONS	MIN.	TYP.	MAX.	UNITS
Maximum junction and storage temperature range	T _J , T _{Stg}		-55	-	175	°C
Thermal resistance, junction to case	R _{thJC}		-	-	2.2	°C/W
Marking device		Case style SlimDPAK (TO-252AE)	8EVX06			

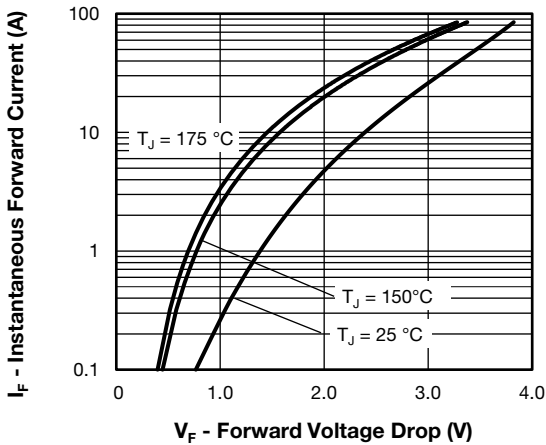

Fig. 1 - Typical Forward Voltage Drop Characteristics

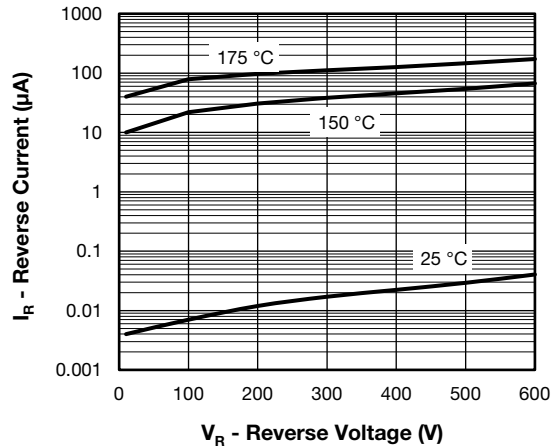

Fig. 2 - Typical Values of Reverse Current vs. Reverse Voltage

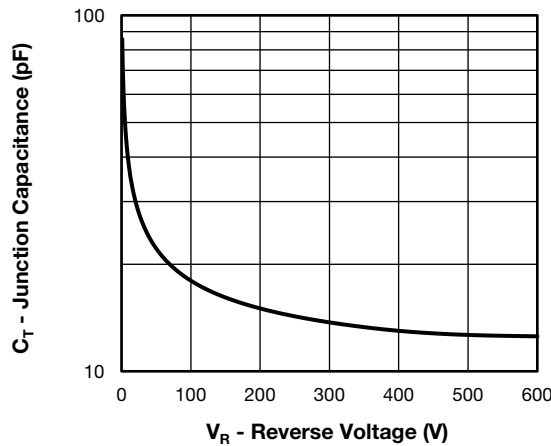

Fig. 3 - Typical Junction Capacitance vs. Reverse Voltage

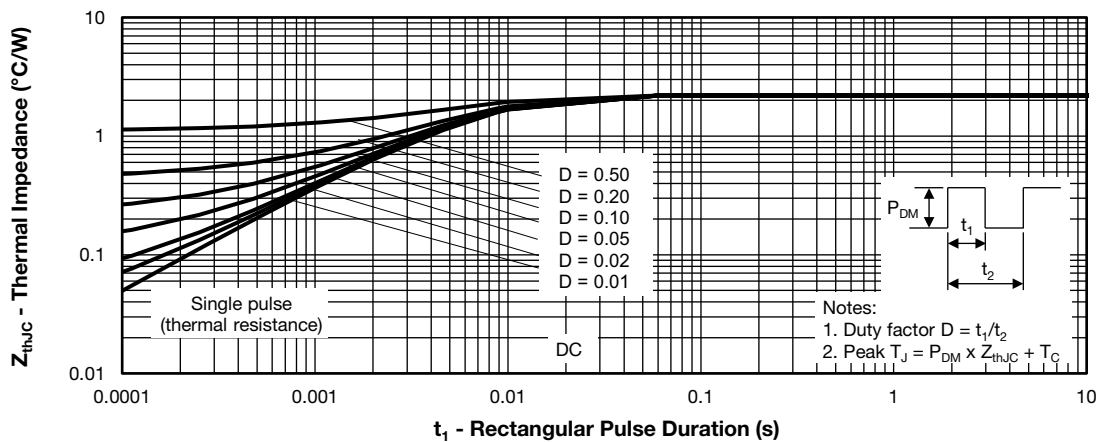

Fig. 4 - Maximum Thermal Impedance Z_{thJC} Characteristics

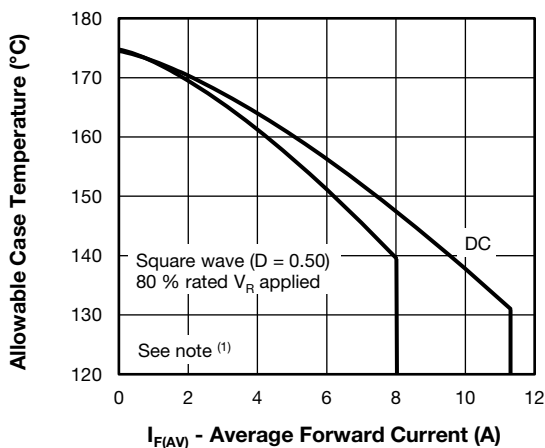

Fig. 5 - Maximum Allowable Case Temperature vs. Average Forward Current

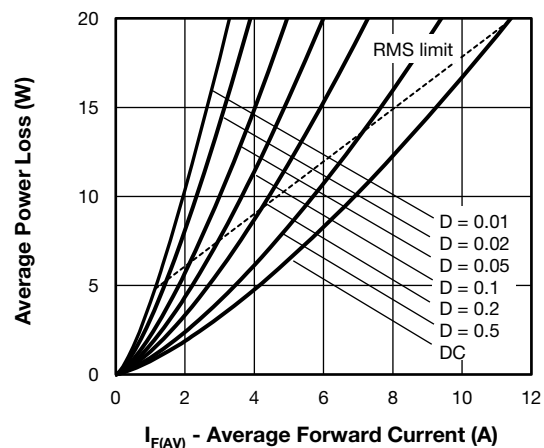
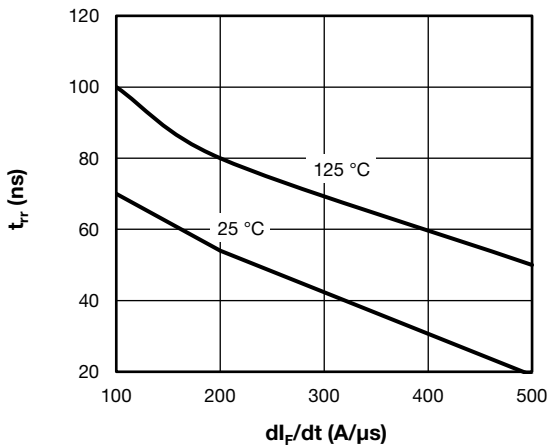
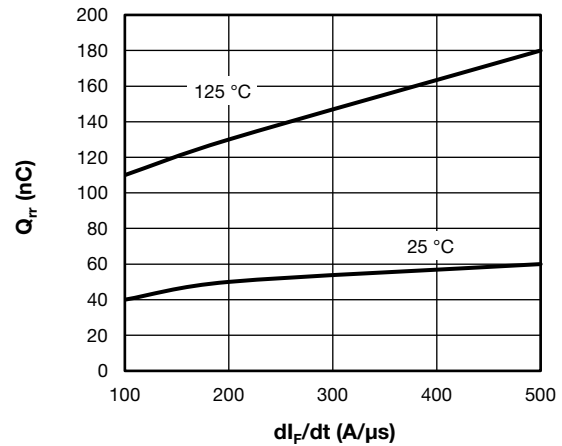
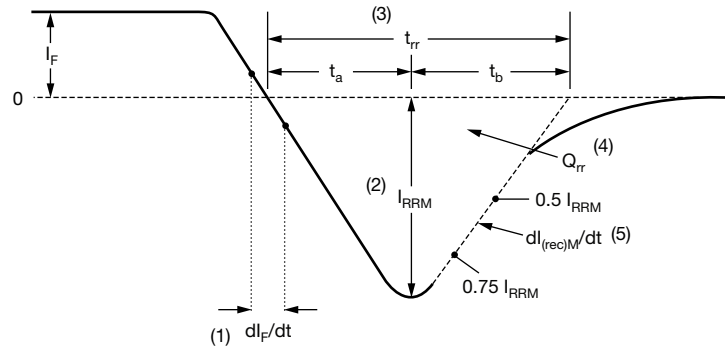

Fig. 6 - Forward Power Loss Characteristics

Note

- (1) Formula used: $T_C = T_J - (P_d + P_{d_{REV}}) \times R_{thJC}$;
 P_d = forward power loss = $I_{F(AV)} \times V_{FM}$ at $(I_{F(AV)}/D)$ (see fig. 6);
 $P_{d_{REV}}$ = inverse power loss = $V_{R1} \times I_R (1 - D)$; I_R at V_{R1} = rated V_R

 Fig. 7 - Typical Reverse Recovery Time vs. di_F/dt

 Fig. 8 - Typical Stored Charge vs. di_F/dt

- (1) di_F/dt - rate of change of current through zero crossing
- (2) I_{RRM} - peak reverse recovery current
- (3) t_{rr} - reverse recovery time measured from zero crossing point of negative going I_F to point where a line passing through $0.75 I_{RRM}$ and $0.50 I_{RRM}$ extrapolated to zero current.

- (4) Q_{rr} - area under curve defined by t_{rr} and I_{RRM}

$$Q_{rr} = \frac{t_{rr} \times I_{RRM}}{2}$$

- (5) $dl_{(rec)M}/dt$ - peak rate of change of current during t_b portion of t_{rr}

Fig. 9 - Reverse Recovery Waveform and Definitions



ORDERING INFORMATION TABLE

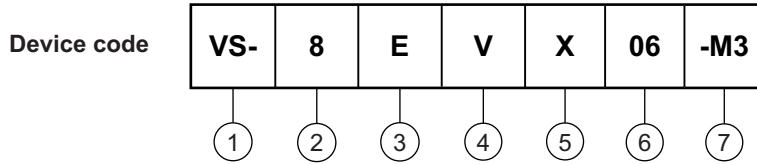

- 1** - Vishay Semiconductors product
- 2** - Current rating (8 = 8 A)
- 3** - Circuit configuration:
E = single die
- 4** - V = SlimDPAK
- 5** - Process type:
X = hyperfast rectifier
- 6** - Voltage code (06 = 600 V)
- 7** - Environmental digit:
M3 = halogen-free, RoHS-compliant, and terminations lead (Pb)-free

ORDERING INFORMATION (Example)				
PREFERRED P/N	UNIT WEIGHT (g)	PREFERRED PACKAGE CODE	BASE QUANTITY	PACKAGING DESCRIPTION
VS-8EVX06-M3/I	0.20	1	4500	13" diameter plastic tape and reel

LINKS TO RELATED DOCUMENTS	
Dimensions	www.vishay.com/doc?96081
Part marking information	www.vishay.com/doc?96085
Packaging information	www.vishay.com/doc?88869



SlimDPAK

DIMENSIONS in inches (millimeters)

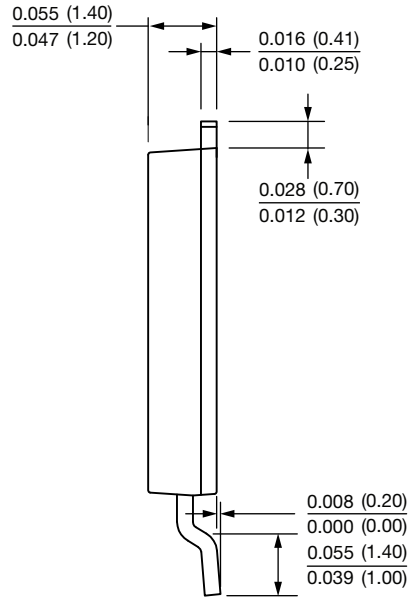



Disclaimer

ALL PRODUCT, PRODUCT SPECIFICATIONS AND DATA ARE SUBJECT TO CHANGE WITHOUT NOTICE TO IMPROVE RELIABILITY, FUNCTION OR DESIGN OR OTHERWISE.

Vishay Intertechnology, Inc., its affiliates, agents, and employees, and all persons acting on its or their behalf (collectively, "Vishay"), disclaim any and all liability for any errors, inaccuracies or incompleteness contained in any datasheet or in any other disclosure relating to any product.

Vishay makes no warranty, representation or guarantee regarding the suitability of the products for any particular purpose or the continuing production of any product. To the maximum extent permitted by applicable law, Vishay disclaims (i) any and all liability arising out of the application or use of any product, (ii) any and all liability, including without limitation special, consequential or incidental damages, and (iii) any and all implied warranties, including warranties of fitness for particular purpose, non-infringement and merchantability.

Statements regarding the suitability of products for certain types of applications are based on Vishay's knowledge of typical requirements that are often placed on Vishay products in generic applications. Such statements are not binding statements about the suitability of products for a particular application. It is the customer's responsibility to validate that a particular product with the properties described in the product specification is suitable for use in a particular application. Parameters provided in datasheets and / or specifications may vary in different applications and performance may vary over time. All operating parameters, including typical parameters, must be validated for each customer application by the customer's technical experts. Product specifications do not expand or otherwise modify Vishay's terms and conditions of purchase, including but not limited to the warranty expressed therein.

Except as expressly indicated in writing, Vishay products are not designed for use in medical, life-saving, or life-sustaining applications or for any other application in which the failure of the Vishay product could result in personal injury or death. Customers using or selling Vishay products not expressly indicated for use in such applications do so at their own risk. Please contact authorized Vishay personnel to obtain written terms and conditions regarding products designed for such applications.

No license, express or implied, by estoppel or otherwise, to any intellectual property rights is granted by this document or by any conduct of Vishay. Product names and markings noted herein may be trademarks of their respective owners.