

Super Manual Fiber Amplifier

# E3X-NA

*Adjuster type standard that is the culmination of true ease and simplicity*



## Features

### Self-explanatory LED bar displays of light levels

The previous manual type used the stability and incident level indicators to display the light level change, which was difficult to understand at a glance. The E3X-NA uses the LED bars to display the light level, ensuring the light level change at a glance.

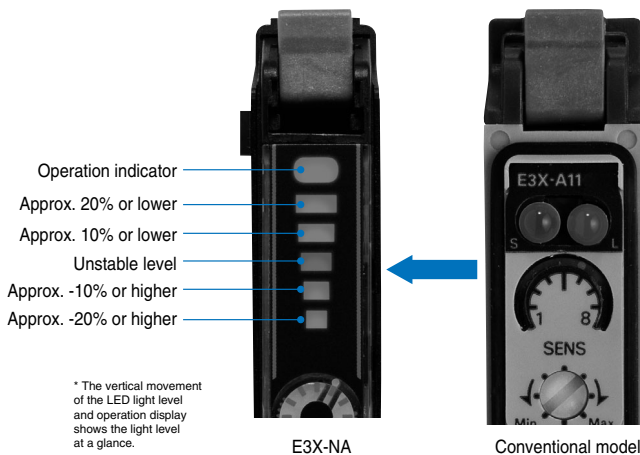

### Same "Wire-saving" Connector as E3X-DA-N

OMRON's original wiring-saving connector, which was inherited from the digital fiber amplifier E3X-DA-N, allows connection of up to 16 units.

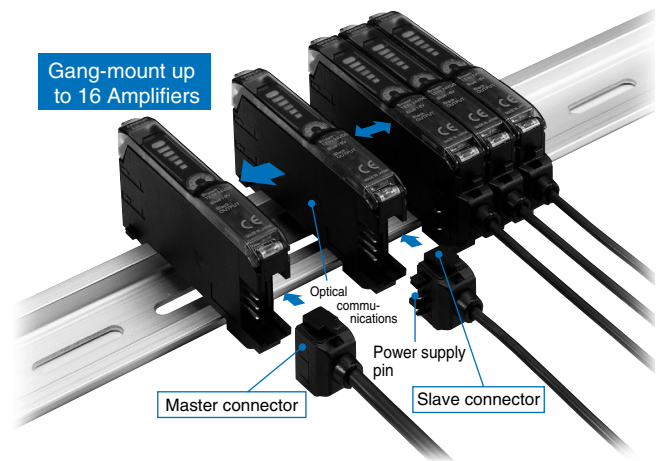

Features

Reduced wiring and space requirements for power lines

Example for 5 Amplifiers E3X-NA Series

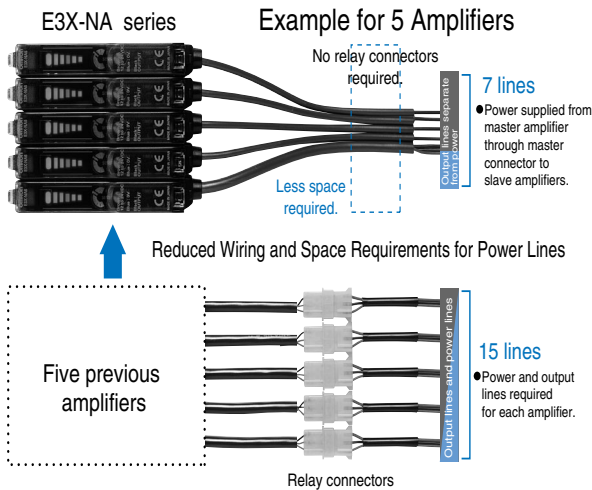

Optical Communications to Prevent Mutual Interference

Optical communication between amplifiers prevents mutual interference. Up to 5 fiber heads can be installed closely, except E3X-NA□F.

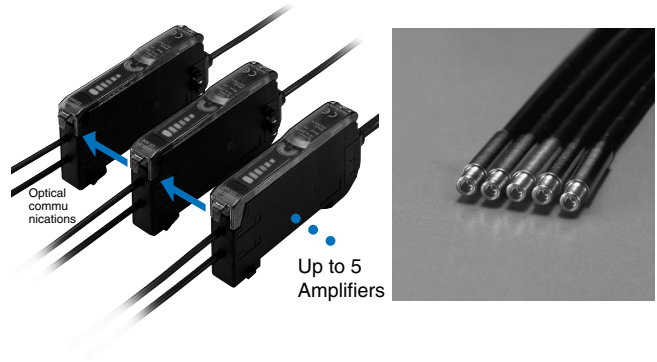

Same Sensing Distance as Previous Long-distance Models

200 mm Reflective Models

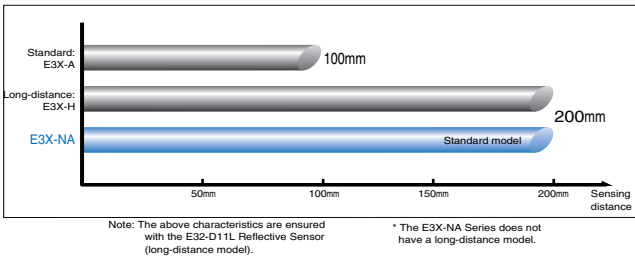

Approximately Seven Times the Detection Accuracy

Applied Fiber: E32-T16P (screen fiber) set at 100 mm. E3X-A1 1 (previous model) Minimum detection object: 2.0 mm dia. E3X-NA 0.3 mm dia.

Applied Fiber: E32-T16 (screen fiber) set at 100 mm.

Minimum detection object: E3X-A11 (previous model) **7 times** E3X-NA **2.0 mm dia. → 0.3 mm dia.**

Addition of high-speed type and waterproof type to the series

Dimensions and Designs Inherited from the E3X-DA-N Digital Fiber Amplifier

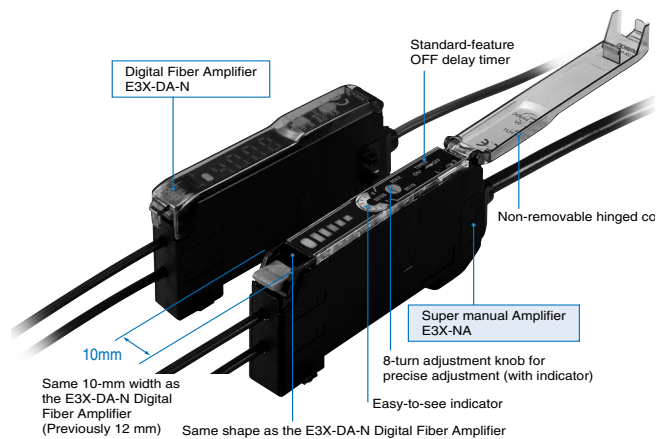



## Ordering Information

### Amplifier Units

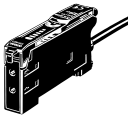
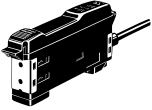

#### Pre-wired

Item	Shape	Control output	Model	
			NPN output	PNP output
Standard models		ON/OFF output	E3X-NA11	E3X-NA41
High-speed detection			E3X-NA11F	E3X-NA41F
Mark-detecting models			E3X-NAG11	E3X-NAG41
Water-resistant models			E3X-NA11V	E3X-NA41V

#### Connector type

Item	Shape	Applicable Connector (order separately)		Control output	Model	
					NPN output	PNP output
Standard models		Master	E3X-CN11	ON/OFF output	E3X-NA6	E3X-NA8
		Slave	E3X-CN12			
Water-resistant models (M8 Connector)		XS3F-M421-40□-A XS3F-M422-40□-A			E3X-NA14V	E3X-NA44V

Amplifier Units Connectors (Order Separately) Note: Stickers for Connectors are included as accessories.



Item	Shape	Cable length	No. of conductors	Model
Master connector		2 m	3	E3X-CN11
Slave connector				1

**Precautions for ordering the connector type**  
Refer to the following tables when placing an order. Basically, Amplifier Units and connectors are sold separately.  
Please place an order after referring to the combination given below.

Amplifier Units			Applicable Connector (order separately)	
Type	NPN	PNP	Master connector	Slave connector
Standard	E3X-NA6	E3X-NA8	E3X-CN11 (3 wires)	E3X-CN12 (1 wire)

**When Using 5 Amplifier Units**  
Amplifier Units (5 Units) + 1 Master Connector + 4 Slave Connectors



### Sensor I/O Connectors (Order separately)

Size	Cable type	Shape	Cable length	Model	
M8	Standard cable	Straight 	2 m	4 conductors	XS3F-M421-402-A
			5 m		XS3F-M421-405-A
		L-shaped 	2 m		XS3F-M422-402-A
			5 m		XS3F-M422-405-A

Note: Refer to page NB-6 for details.

### Accessories (Order Separately)

#### Mounting Brackets

Shape	Applicable type	Model	Quantity
	E3X-NA□ E3X-NA□F E3X-NAG□	E39-L143	1
	E3X-NA□V	E39-L148	

#### End Plate

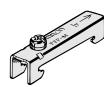
Shape	Model	Quantity
	PFP-M	1

Rating/performance

Amplifier Units

Item	Model	Type	Pre-wired				Connector type	
			Standard models	High-speed de- tection models	Mark-detecting models	Water-resistant models	Standard models	Water-resistant mod- els (M8 Connector)
			NPN output	E3X-NA11	E3X-NA11F	E3X-NAG11	E3X-NA11V	E3X-NA6
	PNP output	E3X-NA41	E3X-NA41F	E3X-NAG41	E3X-NA41V	E3X-NA8	E3X-NA44V	
Light source (wave length)	Red LED (680 nm)		Green LED (520 nm)	Red LED (680 nm)				
Power supply volt- age	12 to 24 VDC ±10%, ripple (p-p): 10% max.							
Current consumption	35 mA max.	35 mA max. (at power supply voltage 24 VDC)	35 mA max.					
Control output	Load current 50 mA (residual voltage 1 V max. each) Open collector output type (depends on the NPN/PNP out- put format) Light-ON/Dark-ON switch selectable							
Response time	Operation or re- set: 200 s max. *	Operating: 20 s max. Reset: 30 s max.	200 s max. for operation and reset respectively (See note.)					
Sensitivity adjust- ment	8-turn endless adjuster (with indicator)							
Protective circuits	Reverse polarity protection, out- put short-circuit protection, mutu- al interference prevention (opti- cally synchro- nized)	Reverse polarity protection, out- put short-circuit protection	Reverse polarity protection, output short-circuit protection, mutual interfer- ence prevention (optically synchronized)					
Timer function	OFF-delay timer: 40 ms (fixed)							
Ambient illuminance	Incandescent lamp: 10,000 lux max. Sunlight: 20,000 lux max.							
Ambient temperature	Operating: Groups of 1 to 3 Amplifiers: -25 to +55°C, Groups of 4 to 11 Amplifiers: -25 to +50°C, Groups of 12 to 16 Amplifiers: -25 to +45°C Storage: -30 to +70°C (with no icing and condensation)							
Ambient humidity	Operating/Storage: 35% to 85% RH (with no condensation)							
Insulation resistance	20 M min. at 500 VDC							
Dielectric strength	1,000 VAC at 50/60 Hz for 1 minute					500 VAC at 50/60 Hz for 1 minute		
Vibration resistance	10 to 55 Hz with a 1.5 mm double amplitude for 2 hrs each in X, Y and Z directions							
Shock resistance	Destruction: 500 m/s <sup>2</sup> for 3 times each in X, Y, and Z directions							
Protective structure	IEC 60529 IP50 (with Protective Cover attached)			IEC 60529 IP66 (with Protective Cover attached)	IEC 60529 IP50 (with Protective Cover attached)	IEC 60529 IP66 (with Protective Cover attached)		
Connection method	Pre-wired models (standard length: 2 m)				Connector type	M8 connector		
Weight (Packed state)	Approx. 100 g			Approx. 110 g	Approx. 55 g	65 g		
Material	Case	PBT (polybutylene terephthalate)						
	Cover	Polycarbonate		Polyethersul- fone (PES)	Polycarbonate	Polyethersul- fone (PES)		
Accessories	Instruction manual							

\* If 8 or more Units are installed side-by-side, the response time will be 350 s max.

Amplifier Unit Connectors

Item	Model	E3X-CN11	E3X-CN12
Rated current		2.5 A	
Rated voltage		50 V	
Contact resistance		20 mΩ max. (20 mVDC max., 100 mA max.) [By connection with amplifier unit and connection with adjacent connector (except conductor resistance of cable)]	
No. of insertions		50 times (By connection with amplifier unit and connection with adjacent connector)	
Material	Housing	PBT (polybutylene terephthalate)	
	Contacts	Phosphor bronze/gold-plated nickel	
Weight (Packed state)		Approx. 55 g	Approx. 25 g

Characteristic data (typical)

Number of Turns of Sensitivity Adjuster vs. Sensing Distance

E32-T11L

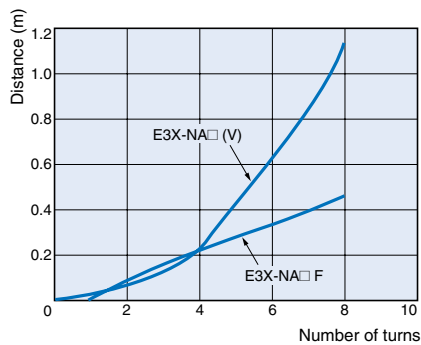

E32-D11L

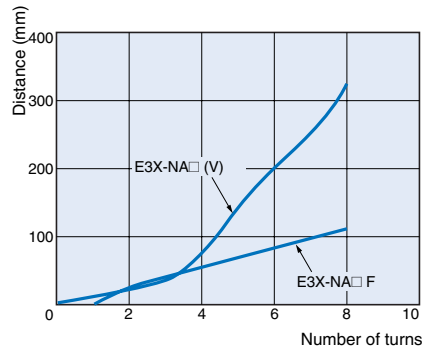

Sensing Distance vs. Hysteresis

E32-T11L

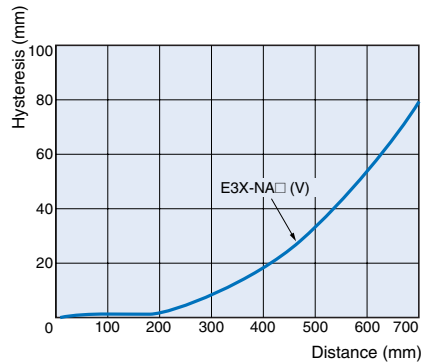

E32-D11L

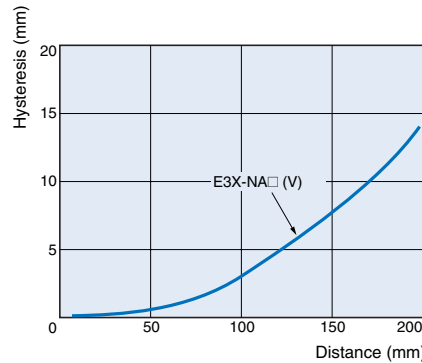

## Output Circuit Diagram

### NPN output

Model	Operating status of output transistor	Timing chart	Mode selection switch	Output circuit
E3X-NA11 E3X-NA6 E3X-NAG11 E3X-NA11F E3X-NA11V E3X-NA14V	Light ON		L ON (LIGHT ON)	<p>M8 Connector Pin Arrangement</p> <p>Note: Pin 2 is open.</p>
	Dark ON		D ON (DARK ON)	

### PNP output

Model	Operating status of output transistor	Timing chart	Mode selection switch	Output circuit
E3X-NA41 E3X-NA8 E3X-NAG41 E3X-NA41F E3X-NA41V E3X-NA44V	Light ON		L ON (LIGHT ON)	<p>M8 Connector Pin Arrangement</p> <p>Note: Pin 2 is open.</p>
	Dark ON		D ON (DARK ON)	

### Connectors (Sensor I/O connectors)

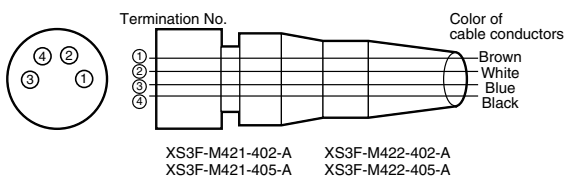

Class	Wire, outer jacket color	Connector pin No.	Application
For DC	Brown	①	Power supply (+V)
	White	②	-
	Blue	③	Power supply (0 V)
	Black	④	Output

Note: Pin 2 is not used.

Nomenclature:

Amplifier Units

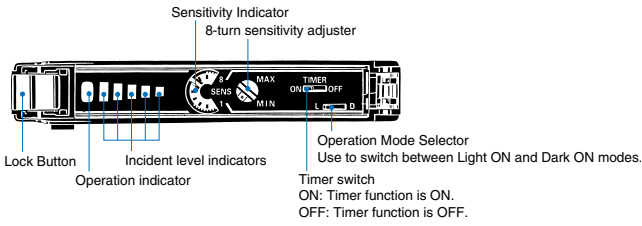

Operation

Indicator status

In addition to the operation indicator (orange), E3X-NA has indicators that denotes the incident level (4 green and 1 red indicators). Use them for optical axis adjustment and maintenance.

Indicator status (L/ON)	Operation indicator (L/ON)	Incident level
<p>Operation indicator Incident level indicators</p> <p>Not lit Lit (See note)</p>	Not lit	Approx. 80% to 90% of operating level
	Not lit	Approx. 80% to 90% of operating level
	Not lit or lit	Approx. 90% to 110% of operating level
	Lit	Approx. 110% to 120% of operating level
	Lit	Approx. 120% min. of operating level

Note: The rightmost indicator is turned ON at the "0 incident level".

Precautions

Correct Use

Amplifier Units

Design

Communications Hole

The window provided in the side face of the unit is a communication window for prevention of mutual interference when it is connected with the other unit. Note that the optional Mobile Console E3X-MC11 cannot be used. When the incident level of the sensor is excessive, mutual interference prevention may not be activated. At that time, make adjustment with the sensitivity adjuster. When the unit is used with the E3X-DA-N series, mutual interference prevention is not activated.

Mounting

Connection/removing of amplifier units

(Connection)

1. Install the Amplifier Units one at a time onto the DIN track.

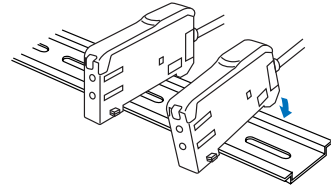

2. Slide the Amplifier Units together, line up the clips, and press the Amplifier Units together until they click into place.

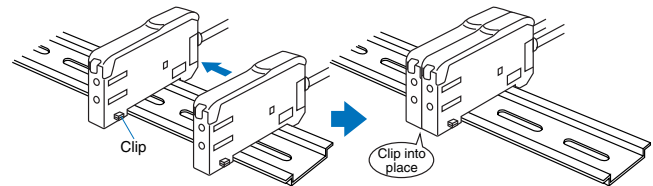

(Removing)

Slide one unit away from the other and remove them one by one. (Do not remove the connected units together from the DIN rail.)

Note: 1. When the amplifier units are interconnected, the operating ambient temperature changes depending on the number of connected amplifier units. Check "Ratings/Performance".  
 2. Before connecting or removing the units, always switch power off.

Operating Environment

Ambient Conditions

Always remove dust, dirt, etc. from the optical communication window, which may disable communication.

Miscellaneous

Protective Cover

Be sure to set the Protective Cover before use.

## Amplifier Unit Connectors

### Installation

#### Installation Connectors

1. Insert the Master or Slave Connector into the Amplifier Unit until it clicks into place.

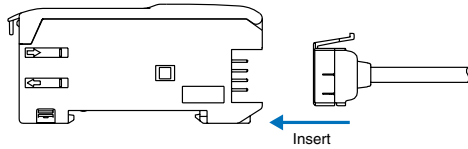

2. Join Amplifier Units together as required after all the Master and Slave Connectors have been inserted.
3. Apply the supplied seal to the non-connection surface of the master/slave connector.

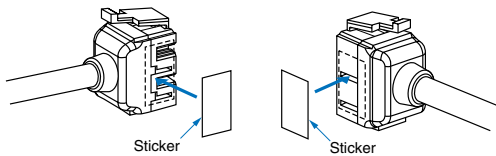

Note: Apply the seal to the grooved side.

#### Removing Connectors

1. Slide the slave Amplifier Unit for which the Connector is to be removed away from the rest of the group.
2. After the Amplifier Unit has been separated, press down on the lever on the Connector and remove it. (Do not attempt to remove Connectors without separating them from other Amplifier Units first.)

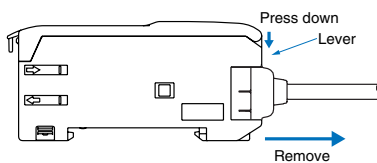

#### Mounting End Plate (PFP-M)

Depending on the installation type, an Amplifier Unit may move during operation. In this case, use an End Plate. Before installing an End Plate, remove the clip from the master Amplifier Unit using a nipper or similar tool.

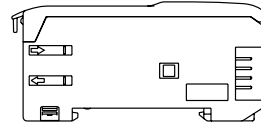

The sensor bottom is also equipped with the clip removing mechanism.

1. Insert the clip to be removed into the slit underneath the clip on another Amplifier Unit.

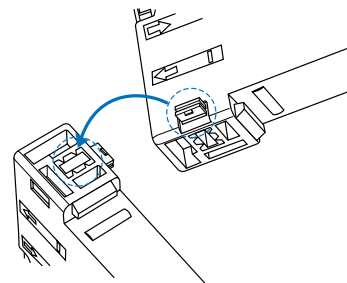

2. Remove the clip by rotating the Amplifier Unit.

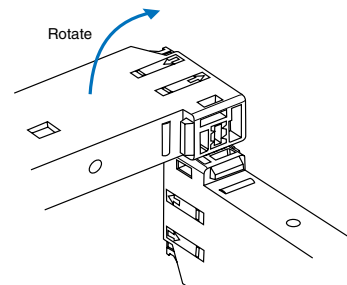

#### Pull Strengths for Connectors (Including Cables)

E3X-CN11: 30 N max. E3X-CN12: 12 N max.



Dimensions (Unit: mm)

Amplifier Units

Pre-wired

- E3X-NA11
- E3X-NA11F
- E3X-NA41
- E3X-NA41F
- E3X-NAG11
- E3X-NAG41

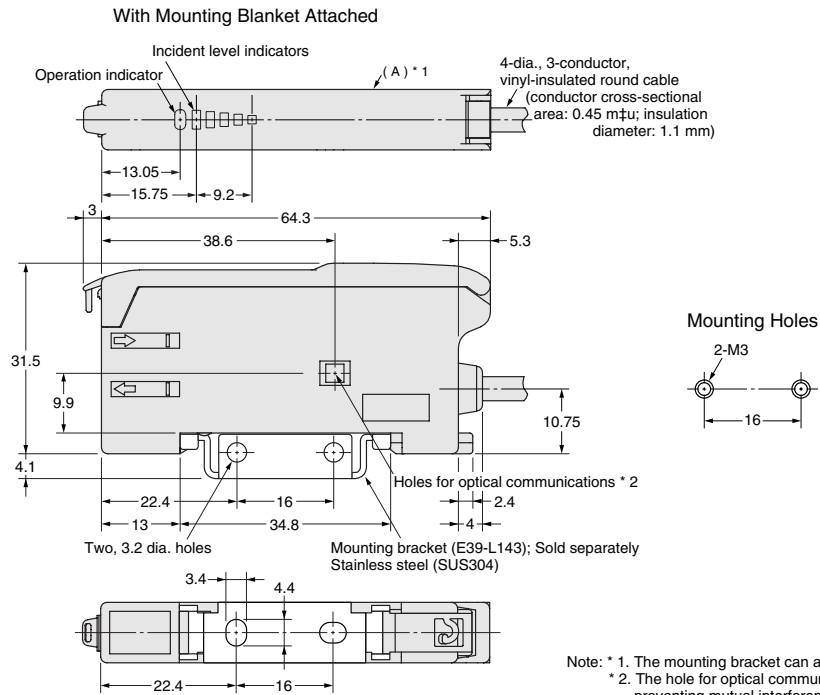
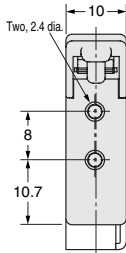
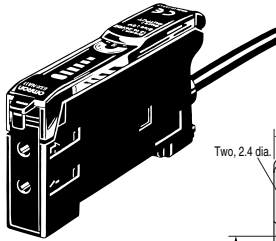

Amplifier Units with cables, Water-resistant Models

- E3X-NA11V
- E3X-NA41V

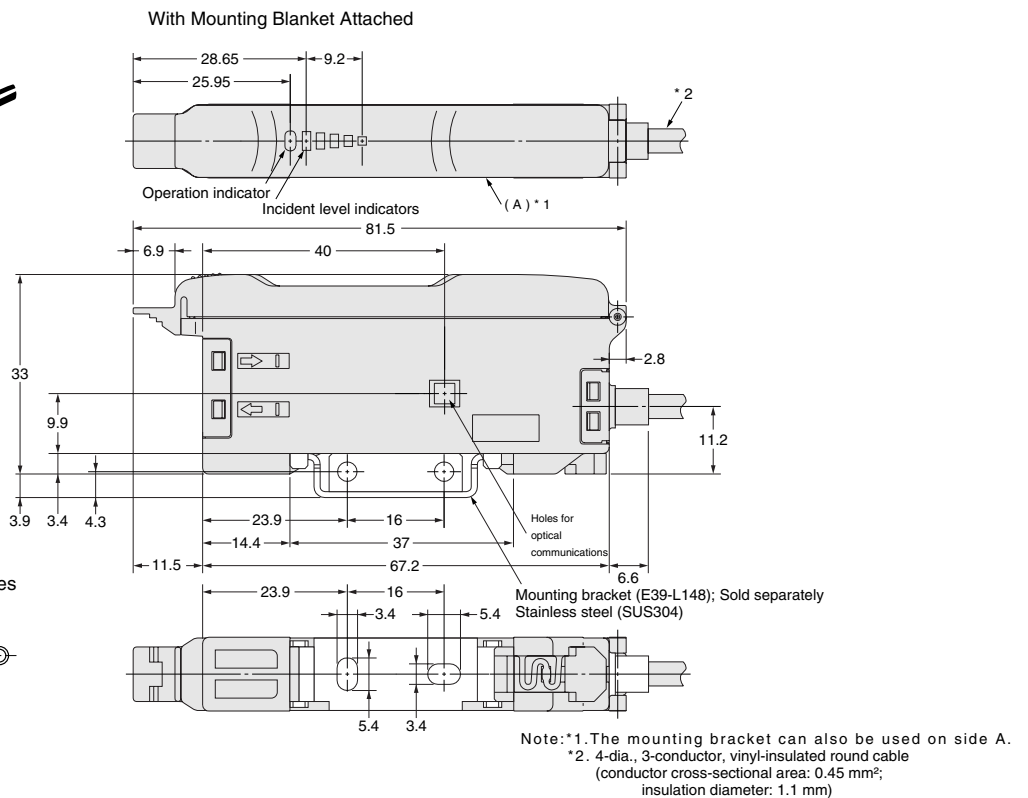
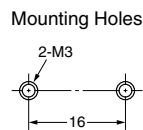
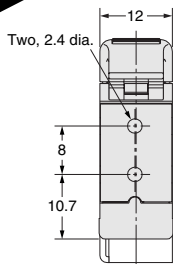
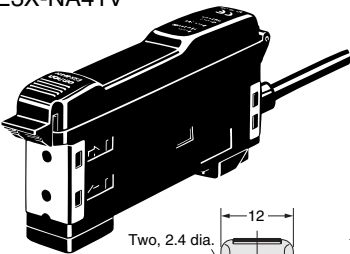

Connector type

E3X-NA6  
E3X-NA8

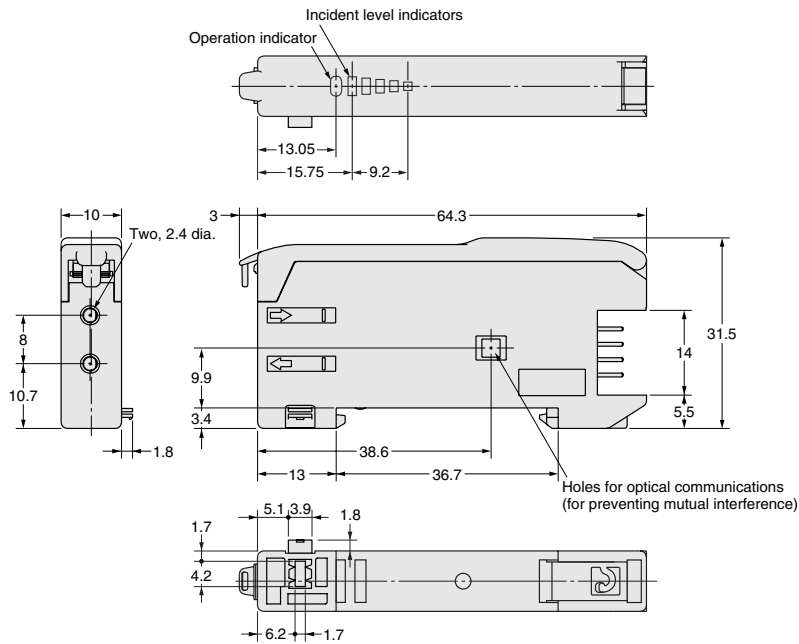
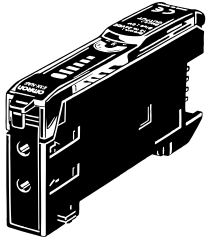

Dimensions with Master Connector Connected

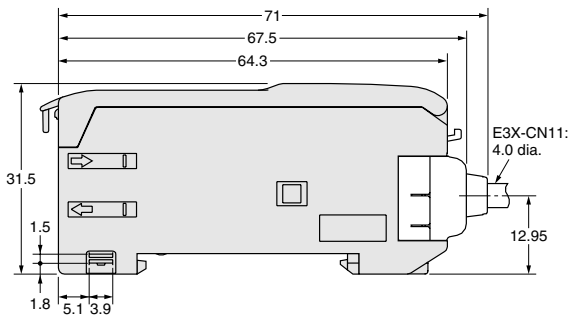

Dimensions with Slave Connector Connected

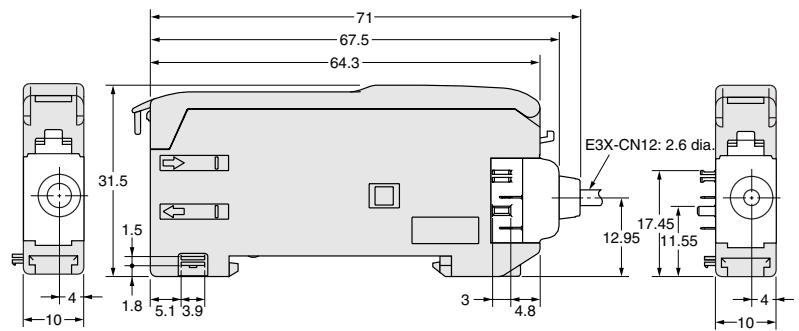

Amplifier Units M8 Connectors,  
Water-resistant Models

E3X-NA14V  
E3X-NA44V



Note: \*1. The mounting bracket can also be used on side A.

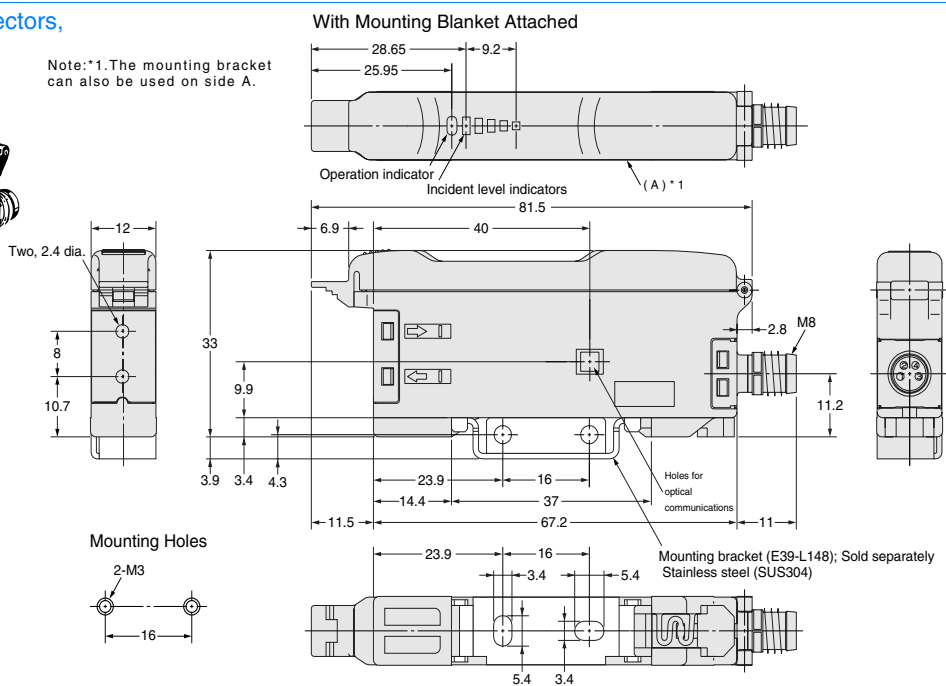

Mounting Holes

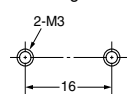

Amplifier Unit Connectors

Master connector

E3X-CN11

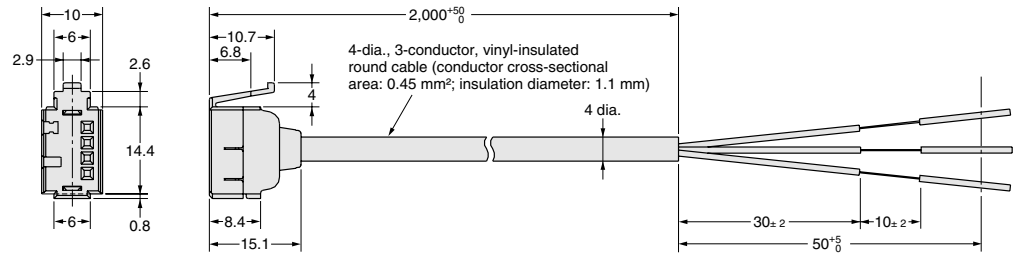
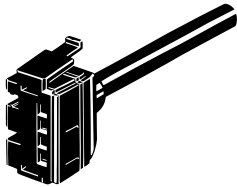

Slave connector

E3X-CN12

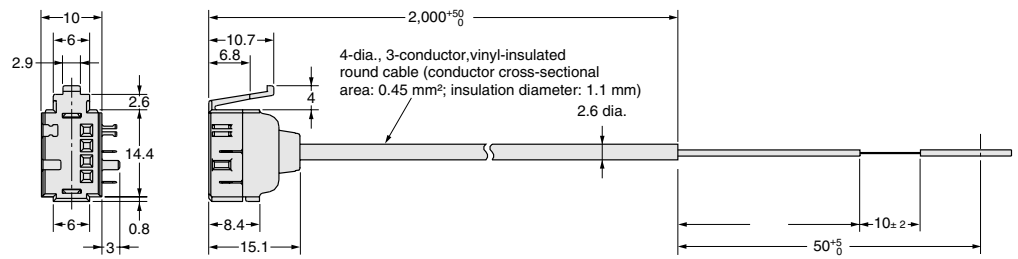
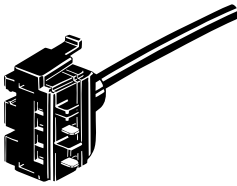

Accessories (Order Separately)

Mounting Brackets

H-5

ALL DIMENSIONS SHOWN ARE IN MILLIMETERS.

To convert millimeters into inches, multiply by 0.03937. To convert grams into ounces, multiply by 0.03527.