

# SPECIFICATIONS

RoHS Compliant



**Model Number:** JQD48U3E2X-E3  
**Part Number:** 17001189A

**Rev:00**  
**Jun 12, 2018**

## Mechanical Drawing:

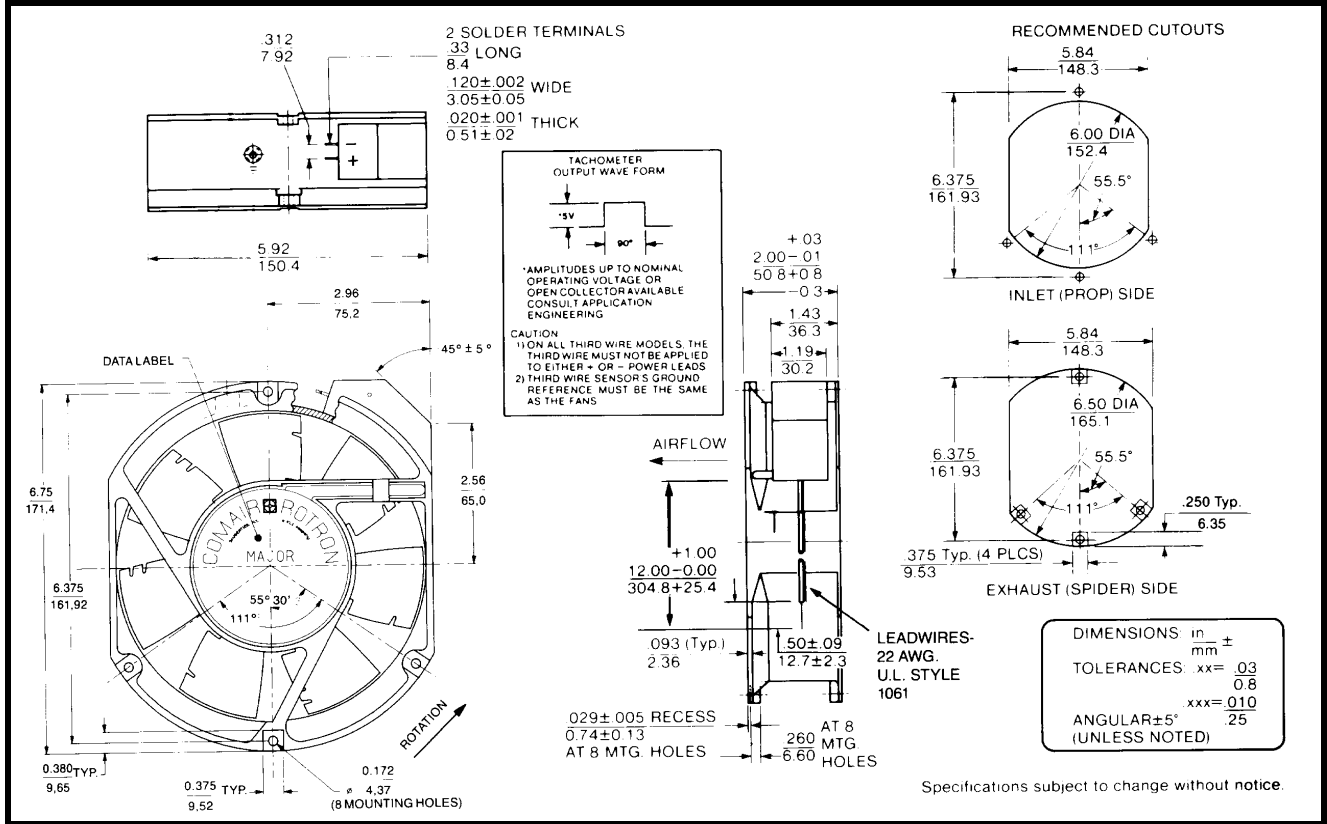

### Motor:

Nominal Voltage	= 48 vdc
Operating Voltage Range	= 36 - 60 vdc
Nominal Running Current	= 0.85mps
Locked Rotor Current	= 2.0 amps
Running Power	= 40.8 watts
Average Speed	= 4830 RPM
Bearings	= Ball
Air Flow	= 332 CFM
Acoustic	= 64.0 dBA

### Construction:

Venturi: Die-cast aluminum, painted black  
 Propeller: Plastic, painted black

### Life Expectancy:

This fan is designed for continuous duty life of 58,000 hours at 70°C.

### Termination:

12"±1"(304.8±25.4mm) 22AWG UL1061 Leadwires

Red	= Power(+)
Black	= Return(-)
Blue/White	= Tach output
Yellow	= PWM control

### Additional Features:

Brushless DC Motor  
 Soft Start Inrush Current  
 Electronic Locked Rotor Protection  
 Polarity Protected  
 Automatic Restart Capability  
 Operating Temperature: -10°C to 70°C  
 Storage Temperature: -40°C to 85°C  
 Environmental Protection: Type 3(IP68)

### TACHOMETER:

Output:	Open Collector
Ic:	20 mA max.
Vcc:	60 Vdc max.
Pulses per Revolution:	2
Isolated:	No

### Speed Control:

PWM: 200 ~ 2 KHz, Open Collector  
 <10% Duty: Off  
 10%~95% Duty: Linear Ramp  
 >95% Duty or Open Lead Wire: Full Speed

### Agency Approvals:

UL, CUL, CE

**PQ Curve:**

