

ISL8200MEVAL1PHZ Evaluation Board User's Guide

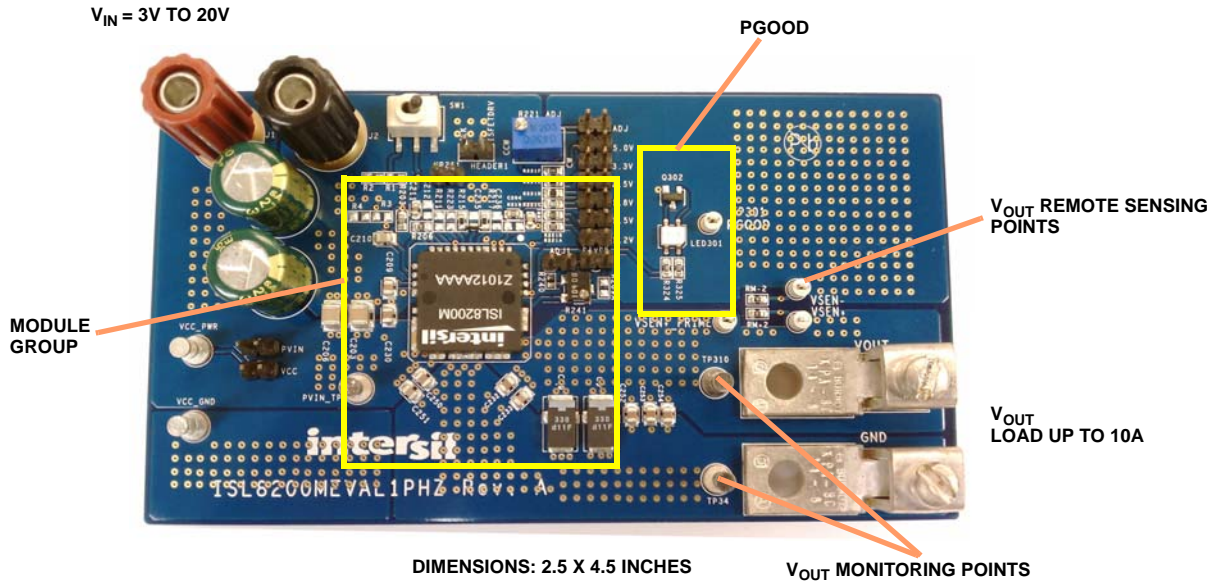

FIGURE 1. ISL8200MEVAL1PHZ EVALUATION BOARD

ISL8200MEVAL1PHZ Evaluation Board

The ISL8200M is a complete 10A step-down current share-able switch mode power module in a low profile package. It can be used in standalone single-phase operation as well as current shared applications where multiple modules are connected in parallel.

The ISL8200MEVAL1PHZ evaluation board is used to demonstrate performance of the ISL8200M in a single phase setup. The input voltage is from 3V to 20V, and the output can support a 10A maximum load with a voltage range from 0.6V up to 6V with the proper output capacitor rating.

Recommended Equipment

- 0V to 20V power supply with at least 15A source current capability.
- One Electronic Load capable of sinking current up to 10A.
- Digital multi-meters (DMMs).

Quick Start

1. Connect the PVIN and GND banana jacks to a power supply and connect a load to the VOUT and GND lugs.
2. A multimeter can be hooked to TP310 (+) and TP34 (-) to monitor VOUT.
3. Open the jumpers marked PVIN and VCC.
4. Short the jumpers marked 1.2V and FIXED. This sets the output voltage to 1.2V and sets the OCP trip point its open condition.

5. Push the toggle on SW1 to the left (with respect to the board above).
6. Set the input supply to 12V.
7. Set the electronic load to a desired load current.
8. Enable the power supply first and then the load, the LED for PGOOD will be red when the module is not regulating.
9. Push the toggle on SW1 to the right, the PGOOD LED should now be green to indicate proper operation.

Shutdown

1. Disable the device by pushing the toggle on SW1 to the left.
2. Turn off the electronic load.
3. Turn off the power supply.

Circuits Description

PVIN and GND banana plugs are the input power terminals. Two input electrolytic caps footprint are provided to handle the input current ripple.

Two Sanyo Poscaps (2TPF330M6, 330μF, ESR 6mΩ) are used as output E-caps. These poscaps are rated for output voltages up to 2V, so they should be removed if a higher VOUT is required. The footprints of the Sanyo capacitors can accommodate T530 (ultra-low ESR) tantalum capacitors for higher voltages.

VOUT and GND are output lugs for load connections.

VSEN+ and VSEN- are output voltage sensing points. These pins can be used to monitor and evaluate the system voltage regulations. If the user wants to use these test posts for

Application Note 1655

remote sensing, RM+2, RM-2 need to be changed to higher values, such as 10Ω.

To assess stability, RM+2 can be changed to a 100Ω resistor, then inject the signal across VSEN+ and VSEN_PRIME.

JP201 is a SIP connector that can be used with R223 = 0Ω installed to inject a clock signal to synchronize the module to. The default phase shift of the CLKOUT signal from the module causes a second module to switch with a phase shift of 180°. This can be demonstrated on the 2-phase evaluation board, ISL8200MEVAL2PHZ.

R203 and C210 are small added filters for the VIN pins.

The Overcurrent Protection (OCP) limit can be controlled by shorting the jumper marked FIXED and populating a resistor in R209A's location, as per your desired OCP trip point. As another option, by shorting the jumper marked ADJ1, you can tune the OCP level using the potentiometer labeled R241. To measure the resistance of R241, simply turn off the part and remove the short across ADJ1 and place a resistance meter across its terminals.

If the application is in the 3.3V range, tie VIN and PVCC to 5.0V. However, in applications that involve a PVIN greater than 5.5V, open the jumper named PVIN, not doing so will increase the probability of tying VCC to a voltage greater than its capability. Shorting the jumper marked VCC will allow you to use a separate power supply for VCC; however this is not a necessity as VCC can be internally generated within the module.

Evaluating Other Output Voltages

The ISL8200MEVAL1PHZ kit has several preset outputs for convenience. 1.2V, 1.5V, 1.8V, 2.5V, 3.3V and 5.0V can be easily selected by shorting their appropriate jumper. There is also a potentiometer provided that will allow for any other output voltage between 0.6V to 6V. Equation 1 governs the relationship between the VSET resistors (R221A thru R221F) and the output voltage.

$$R221X = \frac{(V_{OUT} - V_{REF})}{(V_{REF})} ROS \quad \text{where } V_{REF} = 0.6V \quad (EQ. 1)$$

ROS = 2.2kΩ internal

The output capacitors (C9 and C19) must be changed to support the corresponding output voltage. The onboard output capacitors are rated at 2V max.

Programming the Input Voltage UVLO and its Hysteresis

By modifying the voltage divider at the EN pin connected to the input rail (R1 and R2), the input UVLO and its hysteresis can be programmed. The ISL8200MEVAL1PHZ evaluation board comes stocked with R1 = 8.25kΩ and R2 = 3.01kΩ; this sets the UVLO level at 2.9V for a 3.3V application.

For a 5V application, with a UVLO at 4V and recover at 4.5V, use R1 = 16.6kΩ and R2 = 4.2kΩ. The UVLO equations are re-stated in the following, where R1 and R2 are the upper and lower resistors of the voltage divider at the EN pin respectively, V_{HYS} is the desired UVLO hysteresis and V_{FTH} is the desired UVLO falling threshold; a user selected value. Equation 2 describes V_{HYS} as the point past the programmed UVLO level at which the device turns on again.

For example, in a 5V application where it is desired to have the part turn off at 4V and recover at 4.5V, the V_{HYS} that goes in Equation 3 is 0.5V.

$$UVLO_{TURN-ON} = V_{HYS} + V_{FTH} \quad (EQ. 2)$$

$$R1 = \frac{V_{HYS}}{I_{HYS}} \quad I_{HYS} = N \times 30\mu A \quad (EQ. 3)$$

N = number of phases

$$R2 = \frac{R1 \cdot V_{ENREF}}{V_{FTH} - V_{ENREF}} \quad V_{ENREF} = 0.8V \quad (EQ. 4)$$

For 12V applications, if it is desired to have the IC disabled when the input voltage drops below 9V and restart when V_{IN} recovers above 10.6V, then R1 = 53.33kΩ and R2 = 5.2kΩ.

Efficiency Measurement

The voltage and current meter can be used to measure input/output voltage and current. In order to obtain an accurate measurement and prevent the voltage drop of PCB or wire trace, the voltage meter must be close to the input/output terminals. For simplicity, the measuring point for the input voltage meter is at the PVIN_TP terminal, and the measuring point for the output voltage meter is at the TP310 terminal.

The efficiency equation is shown in Equation 5:

$$\text{Efficiency} = \frac{\text{Output Power}}{\text{Input Power}} = \frac{P_{OUT}}{P_{IN}} = \frac{(V_{OUT} \cdot I_{OUT})}{(V_{IN} \cdot I_{IN})} \quad (EQ. 5)$$

Output Ripple/Noise Measurement

Simple steps should be taken to ensure that there is minimum pickup noise due to high frequency events, which can be magnified by the large ground loop formed by the oscilloscope-probe ground. This means that even a few inches of ground wire on the oscilloscope probe may result in hundreds of millivolts of noise spikes when improperly routed or terminated. This effect can be overcome by using the short loop measurement method to minimize the measurement loop area for reducing the pickup noise. The short loop measurement method is shown in Figure 2.

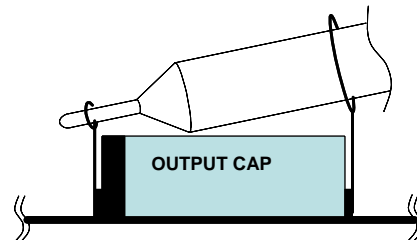
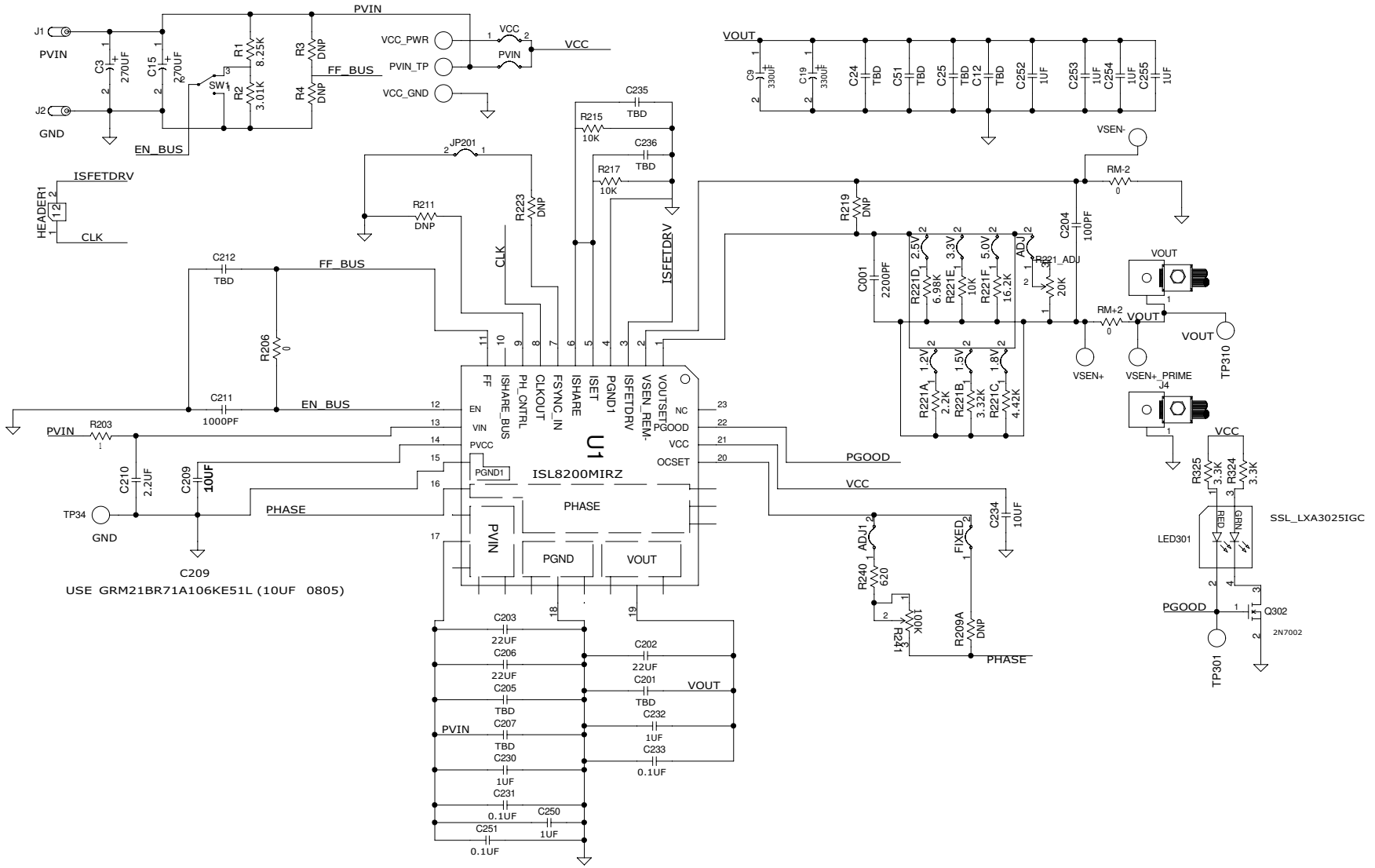

FIGURE 2. OUTPUT RIPPLE/NOISE MEASUREMENT

ISL8200MEVAL1PHZ Schematic



Application Note 1655

ISL8200MEVAL1PHZ Bill of Materials

REF DES.	PART NUMBER	QTY	MANUFACTURER	DESCRIPTION
ADJ, VCC, 1.2V, 1.5V, 1.8V, 2.5V 3.3V, 5.0V, ADJ1, FIXED, JP201	JUMPER2_100	11	Generic	Two Pin Jumper
C001	ECJ-1VB1H222K	1	Panasonic	Capacitor, 2200pF, 10%, 50V, 0603
C12, C25		2	DNP	Capacitor, 0805
C201		1	DNP	Capacitor, 1206
C202, C203, C206	GRM32ER61E226KE15L	3	Murata	Capacitor, 22uF, 10%, 25V, 1210
C204	H1045-00101-50V5	1	Generic	Capacitor, 100pF, 5%, 50V, 0603
C209	GRM21BR71A475KA73	1	Murata	Capacitor, 10µF, 10%, 10V, 0805
C210	GRM21BR71E225KA73L	1	Murata	Capacitor, 2.2µF, 10%, 25V, 0805
C211	H1045-00102-50V10	1	Generic	Capacitor, 1000pF, 10%, 50V, 0603,
C212, C235, C236		3	DNP	Capacitor, 0603
C230, C232, C250, C252-C255	C2012X7R1E105K	7	TDK	Capacitor, 1µF, 10%, 25V, 0805
C231, C233, C251	H1046-00104-25V10	3	Generic	Capacitor, 0.1µF, 10%, 25V, 0805
C234	C3225X7R1E106M	1	TDK	Capacitor, 10µF, 20%, 25V, 1210
C24, C51, C205, C207		4	DNP	Capacitor, 1210
C3, C15	35MV270AX	2	Sanyo	Capacitor, 270µF, 20%, 35V, Radial
C9, C19	2TPLF330M7	2	Sanyo	Capacitor, 330µF, 20%, 2V, SMD
HEADER1	TSW-102-07-L-S	1	Generic	2 Pin Header
J1	111-0702-001	1	JOHNSON-COMP	Binding Post (Red)
J2	111-0703-001	1	JOHNSON-COMP	Binding Post (Black)
J4, VOUT	KPA8CTP	2	Burndy	Wire Connector Lug
LED301	SSL-LXA3025IGC	1	Lumex	3.5mmx2.5mm SMD Red/Green LED
Q302	2N7002L	1	On-Semi	N-Channel 60V 115mA MOSFET (SOT23)
R1	H2511-08251-1/16W1	1	Generic	Resistor, 8.25kΩ, 1%, 1/16W, 0603
R2	H2511-03011-1/16W1	1	Generic	Resistor, 3.01kΩ, 1%, 1/16W, 0603
R203	H2511-00010-1/10W1	1	Generic	Resistor, 1Ω, 1%, 1/10W, 0603
R206, RM+2, RM-2	ERJ3GEY0R00V	3	Panasonic	Resistor, 0Ω, 0%, 1/10W, 0603
R211, R219, R233, R209A	H2505-DNP-DNP-R1	4	DNP	Resistor, 0603
R215, R217, R221E	H2511-01002-1/10W1	3	Generic	Resistor, 10kΩ, 1%, 1/10W, 0603
R221_ADJ	3262W-1-203	1	Bourns	Potentiometer, 20kΩ, 10%, 1/4W, RADIAL
R221A	H2505-02201-1/16WR1	1	Generic	Resistor, 2.2kΩ, 0.1%, 1/16W, 0603
R211B	H2511-03321-1/16W1	1	Generic	Resistor, 3.32kΩ, 0.1%, 1/16W, 0603

Application Note 1655

ISL8200MEVAL1PHZ Bill of Materials (Continued)

REF DES.	PART NUMBER	QTY	MANUFACTURER	DESCRIPTION
R221C	H2511-04421-1/16W1	1	Generic	Resistor, 4.42kΩ, 0.1%, 1/16W, 0603
R221D	H2511-06981-1/16W1	1	Generic	Resistor, 6.98kΩ, 0.1%, 1/16W, 0603
R221F	H2511-01622-1/16W1	1	Generic	Resistor, 16.2kΩ, 0.1%, 1/16W, 0603
R240	H2510-06200-1/16W1	1	Generic	Resistor, 620Ω, 1%, 1/16W, 0603
R241	SM-3TW104	1	Copal	Potentiometer, 100kΩ, 20%, 0.125W, SMD
R3, R4	H2505-DNP-DNP-1	2	DNP	Resistor, 0603
R324, R325	H2505-03301-1/16WR1	2	Generic	Resistor, 3.3kΩ, 0.1%, 1/16W, 0603
SW1	GT11MSCBE-T	1	C&K	Switch, SPDT Toggle
TP301, VSEN+, VSEN-, VSEN_PRIME	5002	4	Keystone	Miniature White Test points 0.100 pad with 0.040 t-hole
TP34, TP310, PVIN_TP, VCC_GND, VDD_PWR	1514-2	5	Keystone	Test point, Turret, 0.150 pads with 0.100 t-hole
U1	ISL8200MIRZ	1	Intersil	Current-Share Capable 10A DC/DC Power Module

ISL8200MEVAL1PHZ Board Layout

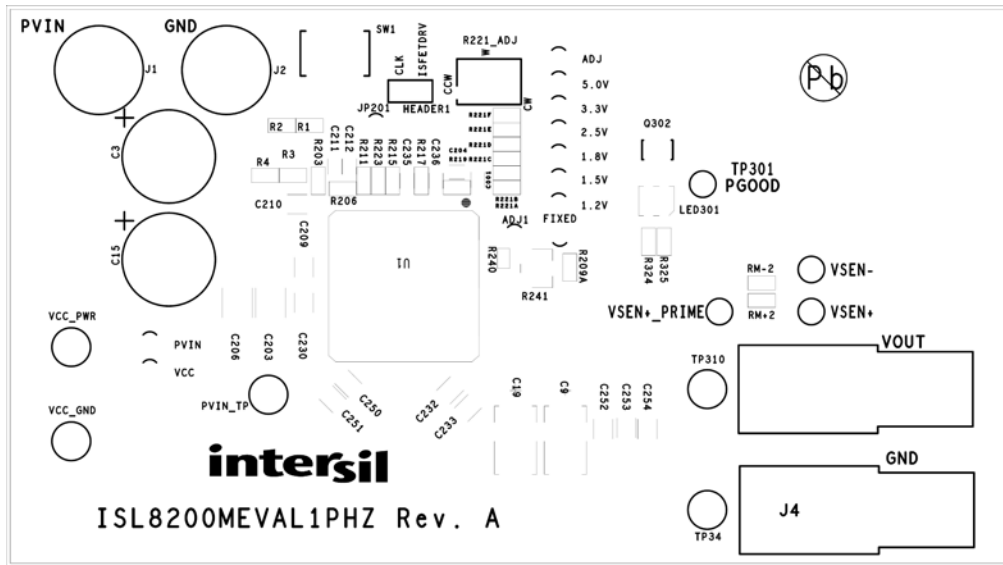

FIGURE 3. TOP COMPONENTS

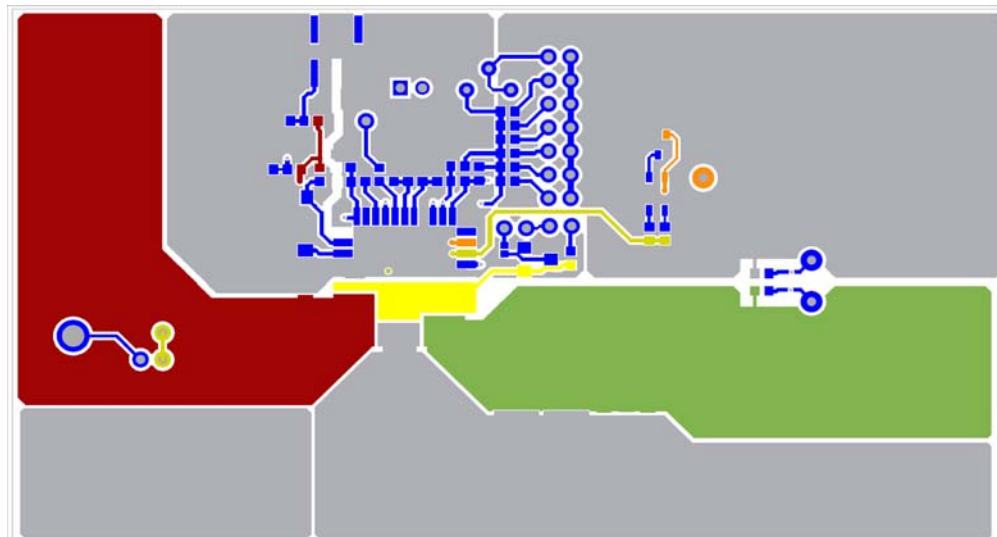

FIGURE 4. TOP LAYER

ISL8200MEVAL1PHZ Board Layout (Continued)

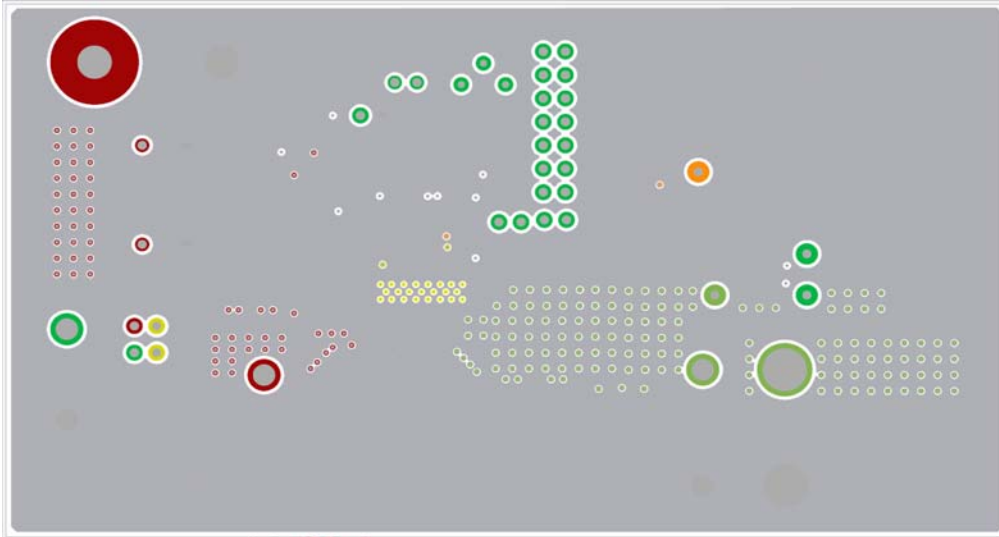

FIGURE 5. 2nd LAYER

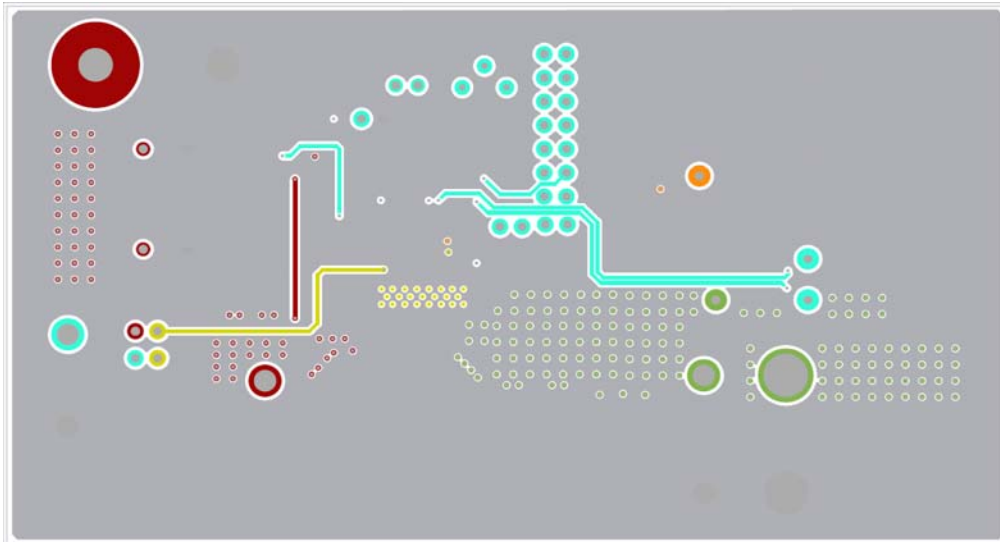

FIGURE 6. 3rd LAYER

ISL8200MEVAL1PHZ Board Layout (Continued)

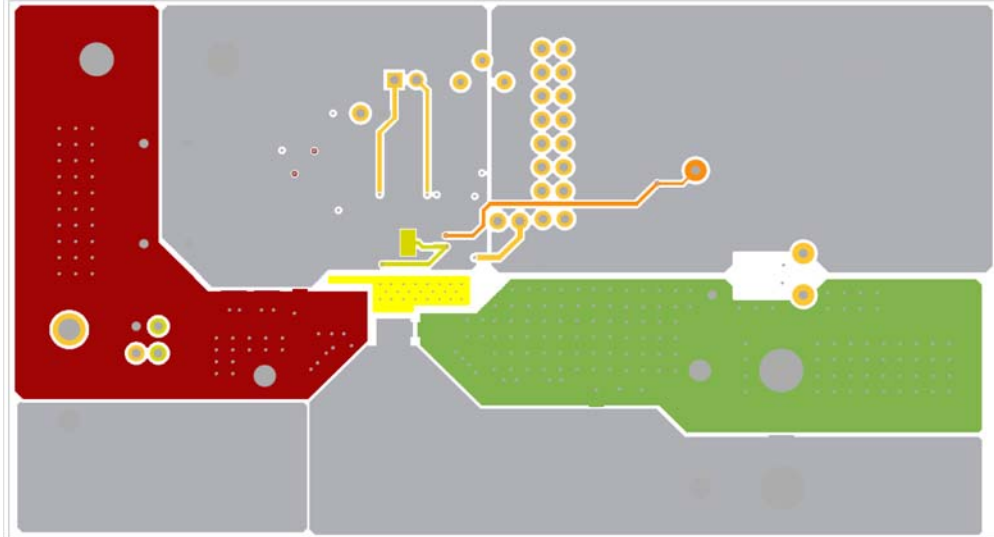

FIGURE 7. BOTTOM LAYER

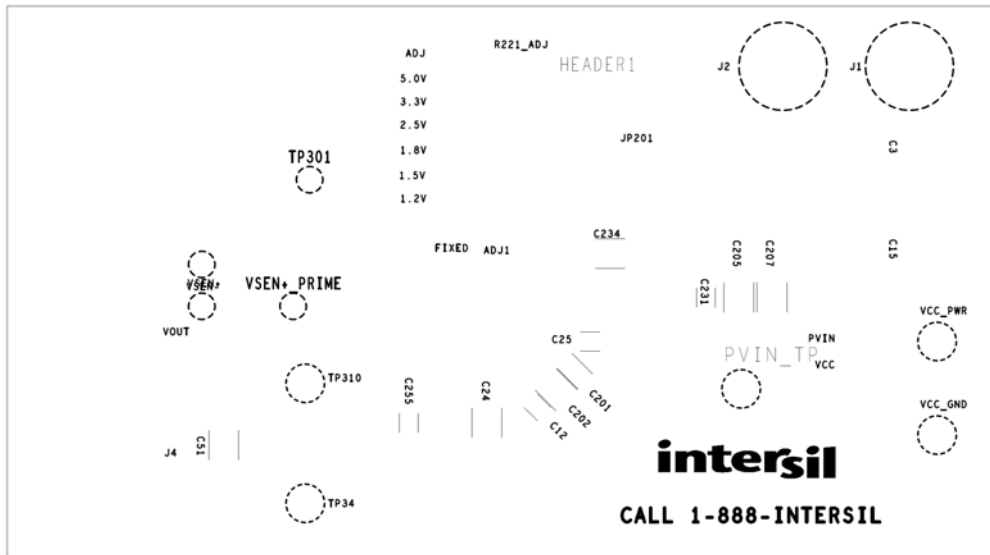

FIGURE 8. BOTTOM COMPONENTS (MIRRORED)

Intersil Corporation reserves the right to make changes in circuit design, software and/or specifications at any time without notice. Accordingly, the reader is cautioned to verify that the Application Note or Technical Brief is current before proceeding.

For information regarding Intersil Corporation and its products, see www.intersil.com