

# FSA646

## 2:1 MIPI D-PHY (2.5 Gpbs) 4-Data Lane Switch

### Description

The FSA646 is a four-data-lane MIPI, D-PHY switch. This single-pole, double-throw (SPDT) switch is optimized for switching between two high-speed or low-power MIPI sources. The FSA646 is designed for the MIPI specification and allows connection to a SCI or DSI module.

### Features

- Switch Type: SPDT (10x)
- Signal Types:
  - ◆ MIPI, D-PHY
- $V_{CC}$ : 1.5 to 5.0 V
- Input Signals: 0 to 1.3 V
- $R_{ON}$ :
  - ◆ 6  $\Omega$  Typical HS MIPI
  - ◆ 6  $\Omega$  Typical LP MIPI
- $\Delta R_{ON}$ : 0.1  $\Omega$  Typical LP & HS MIPI
- $\Delta R_{ON\_FLAT}$ : 0.9  $\Omega$  Typical LP & HS MIPI
- $I_{CCZ}$ : 1  $\mu$ A Maximum
- $I_{CC}$ : 32  $\mu$ A Typical
- $O_{IRR}$ : -24 dB Typical
- Bandwidth: 2500 MHz Minimum
- Xtalk: -30 dB Typical
- $C_{ON}$ : 1.5 pF Typical
- Skew (P), Skew (O): 6 ps Typical

### Applications

- Cellular Phones, Smart Phones
- Tablets
- Laptops
- Displays



**ON Semiconductor®**

[www.onsemi.com](http://www.onsemi.com)

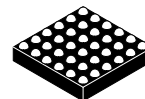

(Bottom View)

**WLCSP36, 2.43x2.43x0.4  
CASE 567WJ**

### MARKING DIAGRAM

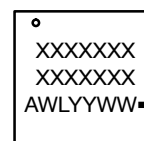

A	= Assembly Location
WL	= Wafer Lot
YY	= Year
WW	= Work Week
▪	= PB-Free Package

### ORDERING INFORMATION

See detailed ordering and shipping information on page 2 of this data sheet.

# FSA646

## ORDERING INFORMATION

Part Number	Top Marking	Package	Top Mark
FSA646UCX	-40 to +85°C	36-Ball WLCSP, Non-JEDEC 2.43 x 2.43 mm, 0.4 mm Pitch	GS

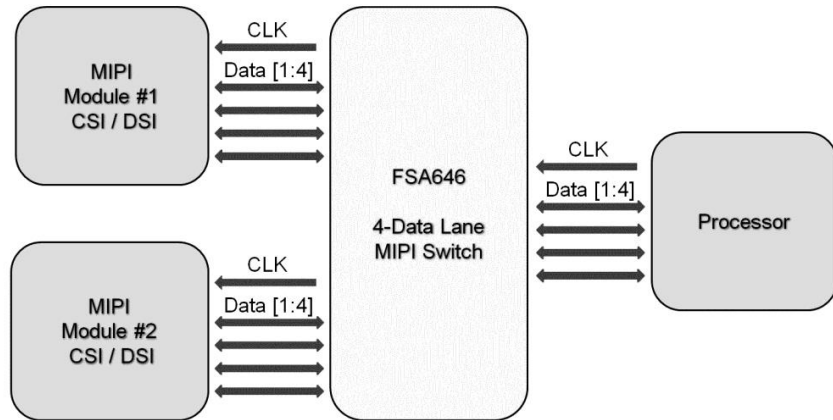

Figure 1. Typical Application

## PIN DESCRIPTIONS

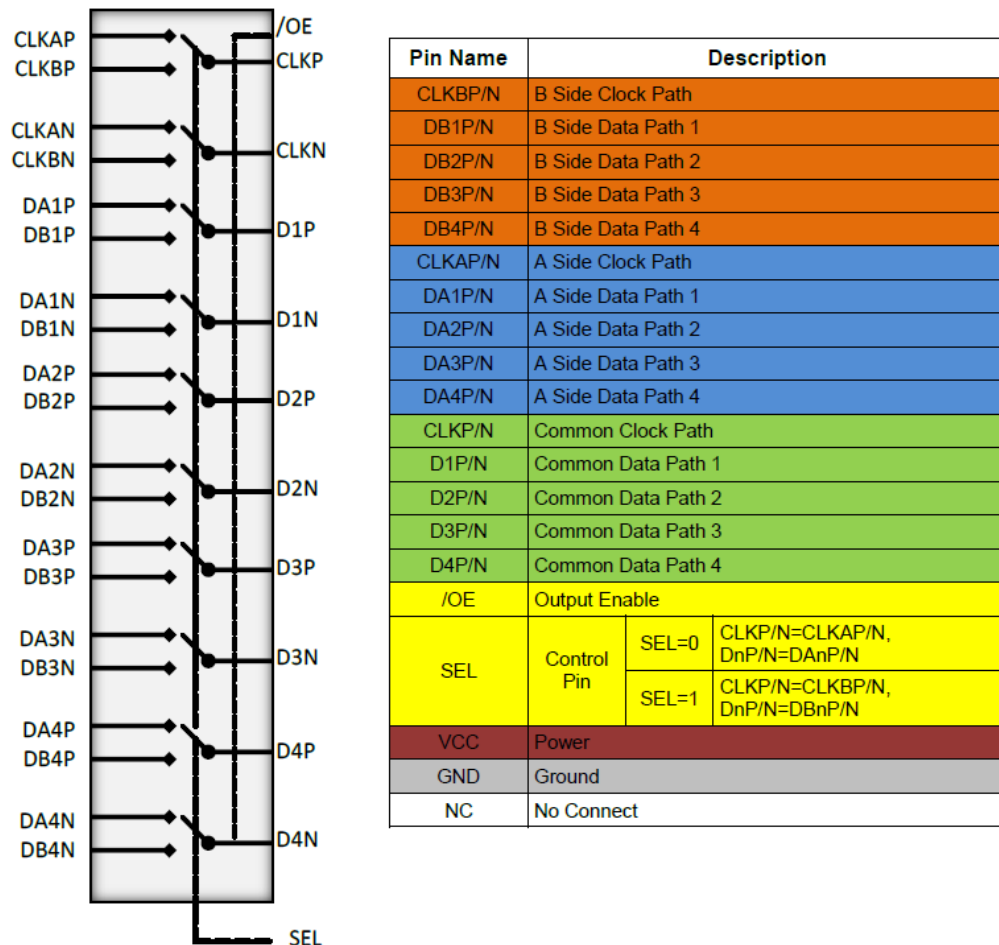

Figure 2. Analog Symbol

PIN DEFINITIONS

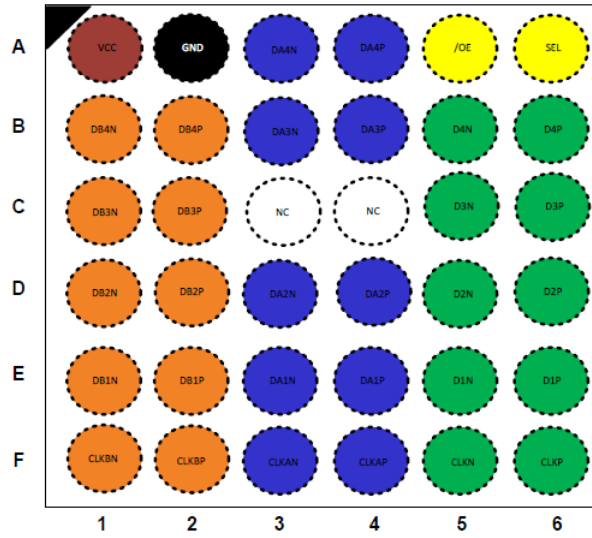

Figure 3. Top Through View

Table 1. BALL-TO-PIN MAPPINGS

Ball	Pin Name	Ball	Pin Name	Ball	Pin Name
A1	V <sub>CC</sub>	C1	DB3N	E1	DB1N
A2	GND	C2	DB3P	E2	DB1P
A3	DA4N	C3	NC	E3	DA1N
A4	DA4P	C4	NC	E4	DA1P
A5	/OE	C5	D3N	E5	D1N
A6	SEL	C6	D3P	E6	D1P
B1	DB4N	D1	DB2N	F1	CLKBN
B2	DB4P	D2	DB2P	F2	CLKBP
B3	DA3N	D3	DA2N	F3	CLKAN
B4	DA3P	D4	DA2P	F4	CLKAP
B5	D4N	D5	D2N	F5	CLKN
B6	D4P	D6	D2P	F6	CLKP

TRUTH TABLE

SEL	/OE	Function
LOW	LOW	CLK <sub>P</sub> = CLKA <sub>P</sub> , CLK <sub>N</sub> = CLKA <sub>N</sub> , D <sub>n</sub> (P/N) = DAN(P/N)
HIGH	LOW	CLK <sub>P</sub> = CLKB <sub>P</sub> , CLK <sub>N</sub> = CLKB <sub>N</sub> , D <sub>n</sub> (P/N) = DBn(P/N)
X	HIGH	Clock and Data Ports High Impedance

# FSA646

## ABSOLUTE MAXIMUM RATINGS

Symbol	Parameter		Min.	Max.	Unit
V <sub>CC</sub>	Supply Voltage		-0.5	6.0	V
V <sub>CNTRL</sub>	DC Input Voltage (/OE, SEL) (Note 1)		-0.5	V <sub>CC</sub>	V
V <sub>SW</sub>	DC Switch I/O Voltage (Note 1,2)		-0.3	1.8	V
I <sub>IK</sub>	DC Input Diode Current		-50		mA
I <sub>OUT</sub>	DC Output Current			25	mA
T <sub>STG</sub>	Storage Temperature		-65	+150	°C
ESD	Human Body Model, JEDEC: JESD22-A114	All Pins	2.0		kV
	Charged Device Model, JEDEC: JESD22-C101		1.0		
	IEC 61000-4-2 System	Contact	8.0		
		Air Gap	15.0		

Stresses exceeding those listed in the Maximum Ratings table may damage the device. If any of these limits are exceeded, device functionality should not be assumed, damage may occur and reliability may be affected.

- The input and output negative ratings may be exceeded if the input and output diode current ratings are observed.
- V<sub>SW</sub> refers to analog data switch paths.

## RECOMMENDED OPERATING CONDITIONS

Symbol	Parameter		Min.	Max.	Unit
V <sub>CC</sub>	Supply Voltage		1.5	5.0	V
V <sub>CNTRL</sub>	Control Input Voltage (SEL, /OE) (Note 3)		0	V <sub>CC</sub>	V
V <sub>SW</sub>	Switch I/O Voltage (CLKn, Dn, CLKA <sub>n</sub> , CLKB <sub>n</sub> , Dan, DBn)	-HS Mode	0	0.3	V
		-LS Mode	0	1.3	V
T <sub>A</sub>	Operating Temperature		-40	+85	°C

Functional operation above the stresses listed in the Recommended Operating Ranges is not implied. Extended exposure to stresses beyond the Recommended Operating Ranges limits may affect device reliability.

- The control inputs must be held HIGH or LOW; they must no float.

## DC AND TRANSIENT CHARACTERISTICS (T<sub>A</sub> = 25°C unless otherwise specified)

Symbol	Parameter	Conditions	V <sub>CC</sub> (V)	T <sub>A</sub> = -40 to +85°C			Unit
				Min.	Typ.	Max.	
V <sub>IK</sub>	Clamp Diode Voltage (/OE, SEL)	I <sub>IN</sub> = -18 mA	1.5	-1.2		-0.6	V
V <sub>IH</sub>	Input Voltage High	SEL, /OE	1.5 to 5	1.3			V
V <sub>IL</sub>	Input Voltage Low	SEL, /OE	1.5 to 5			0.5	V
I <sub>IN</sub>	Control Input Leakage (/OE, SEL)	V <sub>CNTRL</sub> = 0 to V <sub>CC</sub>	5	-0.5		0.5	μA
I <sub>NO(OFF)</sub> I <sub>NC(OFF)</sub>	Off Leakage Current of Port CLKA <sub>n</sub> , Dan, CLKB <sub>n</sub> and DBn	V <sub>SW</sub> = 0.0 ≤ DATA ≤ 1.3 V	5	-0.5		0.5	μA
I <sub>A(ON)</sub>	ON Leakage Current of Common Ports (CLKn, Dn)	V <sub>SW</sub> = 0.0 ≤ DATA ≤ 1.3 V	5	-0.5		0.5	μA
I <sub>OFF</sub>	Power-Off Leakage Current (All I/O Ports)	V <sub>SW</sub> = 0.0 or 1.3 V	0	-0.5		0.5	μA
I <sub>OZ</sub>	Off-State Leakage	V <sub>SW</sub> = 0.0 ≤ DATA ≤ 1.3 V /OE = High	5	-0.5		0.5	μA

# FSA646

## DC AND TRANSIENT CHARACTERISTICS ( $T_A = 25^\circ\text{C}$ unless otherwise specified) (continued)

Symbol	Parameter	Conditions	$V_{CC}$ (V)	$T_A = -40$ to $+85^\circ\text{C}$			Unit
				Min.	Typ.	Max.	
$R_{ON\_MIPI\_HS}$	Switch On Resistance for HS MIPI Applications (Note 4)	$I_{ON} = -8$ mA, /OE = 0 V, SEL = $V_{CC}$ or 0 V, CLKA, CLKB, DB <sub>N</sub> or DA <sub>N</sub> = 0.2 V	1.5		6		$\Omega$
			2.5				
			3.3				
			5				
$R_{ON\_MIPI\_LP}$	Switch On Resistance for LP MIPI Applications (Note 4)	$I_{ON} = -8$ mA, /OE = 0 V, SEL = $V_{CC}$ or 0 V, CLKA, CLKB, DB <sub>N</sub> or DA <sub>N</sub> = 1.2 V	1.5		6		$\Omega$
			2.5				
			3.3				
			5				
$\Delta R_{ON\_MIPI\_HS}$	On Resistance Matching Between HS MIPI Channels (Note 4)	$I_{ON} = -8$ mA, /OE = 0 V, SEL = $V_{CC}$ or 0 V, CLKA, CLKB, DB <sub>N</sub> or DA <sub>N</sub> = 0.2 V	1.5		0.1		$\Omega$
			2.5				
			3.3				
			5				
$\Delta R_{ON\_MIPI\_LP}$	On Resistance Matching Between LP MIPI Channels (Note 4)	$I_{ON} = -8$ mA, /OE = 0 V, SEL = $V_{CC}$ or 0 V, CLKA, CLKB, DB <sub>N</sub> or DA <sub>N</sub> = 1.2 V	1.5		0.1		$\Omega$
			2.5				
			3.3				
			5				
$R_{ON\_FLAT\_MIPI\_HS}$	On Resistance Flatness for HS MIPI Signals (Note 4)	$I_{ON} = -8$ mA, /OE = 0 V, SEL = $V_{CC}$ or 0 V, CLKA, CLKB, DB <sub>N</sub> or DA <sub>N</sub> = 0 to 0.3 V	1.5		0.9		$\Omega$
			2.5				
			3.3				
			5				
$R_{ON\_FLAT\_MIPI\_LP}$	On Resistance Flatness for LP MIPI Signals (Note 4)	$I_{ON} = -8$ mA, /OE = 0 V, SEL = $V_{CC}$ or 0 V, CLKA, CLKB, DB <sub>N</sub> or DA <sub>N</sub> = 0 to 1.3 V	1.5		0.9		$\Omega$
			2.5				
			3.3				
			5				
$I_{CC}$	Quiescent Supply Current (Includes Charge Pump)	$V_{SEL} = 0$ or $V_{CC}$ , $I_{OUT} = 0$ , /OE = 0 V	5			30	$\mu\text{A}$
$I_{CCZ}$	Quiescent Supply Current (High Impedance)	$V_{SEL} = 0$ or $V_{CC}$ , $I_{OUT} = 0$ , /OE = 0 V	5			1	$\mu\text{A}$
$I_{CCT}$	Increase in $I_{CC}$ Current Per Control Voltage and $V_{CC}$	$V_{SEL} = 0$ or $V_{CC}$ , /OE = 1.5 V	5		1		$\mu\text{A}$

4. Measured by the voltage drop between A and B pins at the indicated current through the switch. On resistance is determined by the lower of the voltage on the two (A or B) ports.

## AC ELECTRICAL CHARACTERISTICS ( $V_{CC} = 3.3$ V and $T_A = 25^\circ\text{C}$ unless otherwise specified)

Symbol	Parameter	Conditions	$V_{CC}$ (V)	$T_A = -40$ to $+85^\circ\text{C}$			Unit
				Min.	Typ.	Max.	
$t_{INIT}$	Initialization Time $V_{CC}$ to Output (Note 5)	$R_L = 50$ $\Omega$ , $C_L = 0$ pF, $V_{SW} = 0.6$ V	1.5 to 5		60		$\mu\text{s}$
$t_{EN}$	Enable Time /OE to Output	$R_L = 50$ $\Omega$ , $C_L = 0$ pF, $V_{SW} = 0.6$ V	1.5 to 5		60	150	$\mu\text{s}$
$t_{DIS}$	Disable Time /OE to Output	$R_L = 50$ $\Omega$ , $C_L = 0$ pF, $V_{SW} = 0.6$ V	1.5 to 5		35	250	ns

# FSA646

## AC ELECTRICAL CHARACTERISTICS ( $V_{CC} = 3.3\text{ V}$ and $T_A = 25^\circ\text{C}$ unless otherwise specified) (continued)

Symbol	Parameter	Conditions	$V_{CC}$ (V)	$T_A = -40\text{ to }+85^\circ\text{C}$			Unit
				Min.	Typ.	Max.	
$t_{ON}$	Turn-On Time SEL to Output	$R_L = 50\ \Omega$ , $C_L = 0\ \text{pF}$ , $V_{SW} = 0.6\ \text{V}$	1.5 to 5		350	1100	ns
$t_{OFF}$	Turn-Off Time SEL to Output	$R_L = 50\ \Omega$ , $C_L = 0\ \text{pF}$ , $V_{SW} = 0.6\ \text{V}$	1.5 to 5		125	800	ns
$t_{BBM}$	Break-Before-Make Time	$R_L = 50\ \Omega$ , $C_L = 0\ \text{pF}$ , $V_{SW} = 0.6\ \text{V}$	1.5 to 5	50		450	ns
$t_{PD}$	Propagation Delay (Note 5)	$C_L = 0\ \text{pF}$ , $R_L = 50\ \Omega$	1.5 to 5	30	67	100	ps
$O_{IRR}$	Off Isolation for MIPI (Note 5)	$R_L = 50\ \Omega$ , $f = 1250\ \text{MHz}$ , /OE = HIGH, $V_{SW} = 0.2\ V_{PP}$	1.5 to 5		-24		dB
$X_{TALK}$	Crosstalk for MIPI (Note 5)	$R_L = 50\ \Omega$ , $f = 1250\ \text{MHz}$ , SEL = High, $V_{SW} = 0.2\ V_{PP}$	1.5 to 5		-30	-25	dB
		$R_L = 50\ \Omega$ , $f = 1250\ \text{MHz}$ , SEL = Low, $V_{SW} = 0.2\ V_{PP}$			-30	-25	
BW (Insertion Loss)	-3 db Bandwidth (Note 5)	$R_L = 50\ \Omega$ , $C_L = 0\ \text{pF}$ , $V_{SW} = 0.2\ V_{PP}$	1.5 to 5	2500			MHz
IL	Insertion Loss at 750 MHz (Note 5)	$R_L = 50\ \Omega$ , $C_L = 0\ \text{pF}$ , $V_{SW} = 0.2\ V_{PP}$	1.5 to 5		-0.7		dB

5. Guaranteed by characterization.

## HIGH-SPEED-RELATED AC ELECTRICAL CHARACTERISTICS

Symbol	Parameter	Conditions	$V_{CC}$ (V)	$T_A = -40\text{ to }+85^\circ\text{C}$			Unit
				Min.	Typ.	Max.	
$t_{SK(P)}$	HS Mode Skew of Opposite Transitions of the Same Output (Note 6)	$R_L = 50\ \Omega$ , $C_L = 0\ \text{pF}$ , $V_{SW} = 0.3\ \text{V}$	1.5 to 5		6		ps
$t_{SK(O)}$	HS Mode Skew of Channel-to-Channel Single-Ended Skew (Note 6)	$R_L = 50\ \Omega$ , $C_L = 0\ \text{pF}$ , $V_{SW} = 0.3\ \text{V}$	1.5 to 5		6		ps

6. Guaranteed by characterization.

## CAPACITANCE

Symbol	Parameter	Conditions	$T_A = -40\text{ to }+85^\circ\text{C}$			Unit
			Min.	Typ.	Max.	
$C_{IN}$	Control Pin Input Capacitance (Note 7)	$V_{CC} = 0\ \text{V}$ , $f = 1\ \text{MHz}$		2.1		pF
$C_{ON}$	On Capacitance (Note 7)	$V_{CC} = 3.3\ \text{V}$ , /OE = 0 V, $f = 1250\ \text{MHz}$ (in HS common value)		1.5		
$C_{OFF}$	On Capacitance (Note 7)	$V_{CC}$ and /OE = 3.3 V, $f = 1250\ \text{MHz}$ (both sides in HS common value)		0.9		

7. Guaranteed by characterization.

The table below pertains to the Packaging information on the following page.

## PRODUCT SPECIFIC DIMENSIONS

D	E	X	Y
2.43 mm	2.43 mm	0.215 mm	0.215 mm

**WLCSP36 2.43x2.43x0.4**  
CASE 567WJ  
ISSUE O

DATE 02 MAY 2018

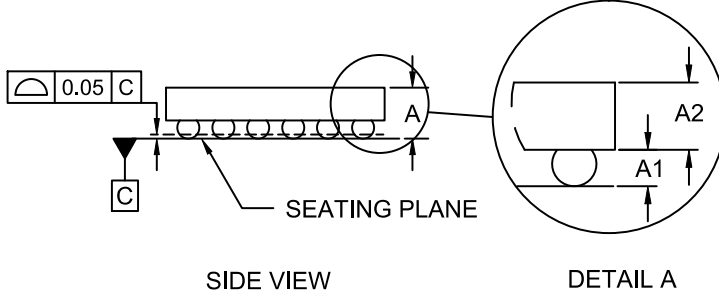
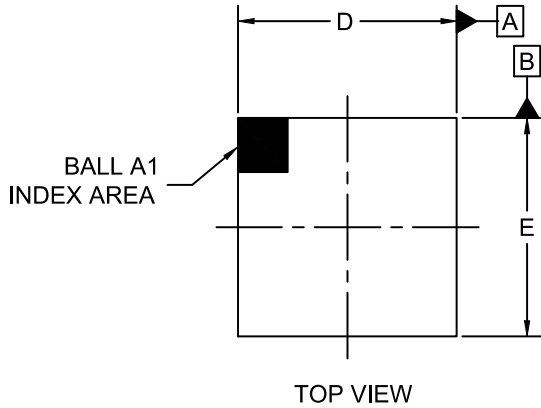

NOTES:

1. DIMENSIONING AND TOLERANCING PER ASME Y14.5M, 2009.
2. CONTROLLING DIMENSION: MILLIMETERS
3. DATUM C APPLIES TO THE SPHERICAL CROWN OF THE SOLDER BALLS

DIM	MILLIMETERS		
	MIN.	NOM.	MAX.
A	0.461	0.500	0.539
A1	0.187	0.208	0.229
A2	0.274	0.292	0.310
b	0.240	0.260	0.280
D	2.400	2.430	2.460
E	2.400	2.430	2.460
e	0.40 BSC		
x	0.200	0.215	0.230
y	0.200	0.215	0.230

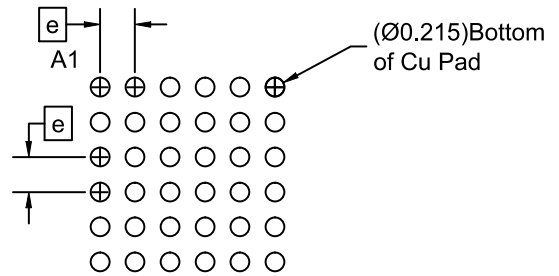
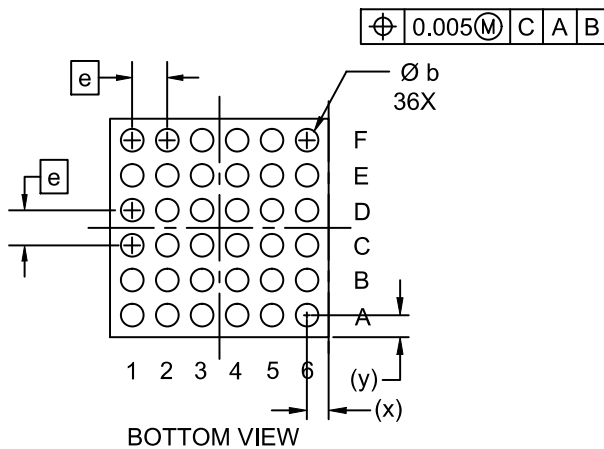

<b>DOCUMENT NUMBER:</b>	<b>98AON87484G</b>	Electronic versions are uncontrolled except when accessed directly from the Document Repository. Printed versions are uncontrolled except when stamped "CONTROLLED COPY" in red.
<b>DESCRIPTION:</b>	<b>WLCSP36 2.43x2.43x0.4</b>	<b>PAGE 1 OF 1</b>

ON Semiconductor and are trademarks of Semiconductor Components Industries, LLC dba ON Semiconductor or its subsidiaries in the United States and/or other countries. ON Semiconductor reserves the right to make changes without further notice to any products herein. ON Semiconductor makes no warranty, representation or guarantee regarding the suitability of its products for any particular purpose, nor does ON Semiconductor assume any liability arising out of the application or use of any product or circuit, and specifically disclaims any and all liability, including without limitation special, consequential or incidental damages. ON Semiconductor does not convey any license under its patent rights nor the rights of others.

ON Semiconductor and  are trademarks of Semiconductor Components Industries, LLC dba ON Semiconductor or its subsidiaries in the United States and/or other countries. ON Semiconductor owns the rights to a number of patents, trademarks, copyrights, trade secrets, and other intellectual property. A listing of ON Semiconductor's product/patent coverage may be accessed at [www.onsemi.com/site/pdf/Patent-Marking.pdf](http://www.onsemi.com/site/pdf/Patent-Marking.pdf). ON Semiconductor reserves the right to make changes without further notice to any products herein. ON Semiconductor makes no warranty, representation or guarantee regarding the suitability of its products for any particular purpose, nor does ON Semiconductor assume any liability arising out of the application or use of any product or circuit, and specifically disclaims any and all liability, including without limitation special, consequential or incidental damages. Buyer is responsible for its products and applications using ON Semiconductor products, including compliance with all laws, regulations and safety requirements or standards, regardless of any support or applications information provided by ON Semiconductor. "Typical" parameters which may be provided in ON Semiconductor data sheets and/or specifications can and do vary in different applications and actual performance may vary over time. All operating parameters, including "Typicals" must be validated for each customer application by customer's technical experts. ON Semiconductor does not convey any license under its patent rights nor the rights of others. ON Semiconductor products are not designed, intended, or authorized for use as a critical component in life support systems or any FDA Class 3 medical devices or medical devices with a same or similar classification in a foreign jurisdiction or any devices intended for implantation in the human body. Should Buyer purchase or use ON Semiconductor products for any such unintended or unauthorized application, Buyer shall indemnify and hold ON Semiconductor and its officers, employees, subsidiaries, affiliates, and distributors harmless against all claims, costs, damages, and expenses, and reasonable attorney fees arising out of, directly or indirectly, any claim of personal injury or death associated with such unintended or unauthorized use, even if such claim alleges that ON Semiconductor was negligent regarding the design or manufacture of the part. ON Semiconductor is an Equal Opportunity/Affirmative Action Employer. This literature is subject to all applicable copyright laws and is not for resale in any manner.

## PUBLICATION ORDERING INFORMATION

### LITERATURE FULFILLMENT:

Literature Distribution Center for ON Semiconductor  
19521 E. 32nd Pkwy, Aurora, Colorado 80011 USA  
**Phone:** 303-675-2175 or 800-344-3860 Toll Free USA/Canada  
**Fax:** 303-675-2176 or 800-344-3867 Toll Free USA/Canada  
**Email:** [orderlit@onsemi.com](mailto:orderlit@onsemi.com)

**N. American Technical Support:** 800-282-9855 Toll Free  
USA/Canada  
**Europe, Middle East and Africa Technical Support:**  
Phone: 421 33 790 2910

**ON Semiconductor Website:** [www.onsemi.com](http://www.onsemi.com)

**Order Literature:** <http://www.onsemi.com/orderlit>

For additional information, please contact your local  
Sales Representative