

ISL8215MEVAL1Z

User's Manual: Evaluation Board

Industrial Analog and Power

ISL8215MEVAL1Z

Evaluation Board

UG105
Rev.0.00
Aug 14, 2017

1. Overview

The ISL8215MEVAL1Z evaluation board (shown in [Figure 1](#)) features the [ISL8215M](#). The ISL8215M is a single channel synchronous step-down power supply, capable of delivering up to 15A of continuous current and optimized for high power density applications without the need for airflow or heatsink.

The ISL8215MEVAL1Z evaluation board is a 1.8inx3in 4-layer FR4 board with 2oz. copper on all layers. Operating from a single 7V to 42V wide input power rail, the ISL8215MEVAL1Z evaluation board offers adjustable output voltages down to 0.6V and efficiencies of up to 96.5%. It is based on a valley current mode PWM control scheme with V_{IN} feed forward, which provides a fast transient response and excellent loop stability. The ISL8215MEVAL1Z evaluation board is designed to program switching frequencies up to 2MHz, with the additional option of synchronizing to an external clock through the SYNC pin. A selectable Pulse Skipping Mode (PSM) with Diode Emulation Mode (DEM) can be enabled easily to improve light-load efficiency for battery-related applications. The evaluation board also features output voltage tracking which can be implemented through the SS/TRK pin.

By default, the board is set to a 3.3V output voltage with a 300kHz switching frequency.

1.1 Key Features

- Wide input voltage range from 7V to 42V
- Adjustable output voltage from 0.6V to 12V with $\pm 1.5\%$ accuracy over line, load, and temperature
- Up to 96.5% conversion efficiency
- High light-load efficiency with pulse skipping DEM operation
- Programmable soft-start with output voltage tracking
- Prebias output start-up
- External frequency synchronization up to 1MHz
- Dedicated enable pin and PGOOD indicator
- UVLO, programmable overcurrent, overvoltage, and over-temperature
- Thermally enhanced 19mmx13mmx5.3mm HDA package

1.2 Specifications

The evaluation board has been configured and optimized for the following operating conditions:

- $V_{IN} = 7V$ to 42V
- $V_{OUT} = 3.3V$
- $I_{OUT-MAX} = 15A$
- $f_{SW} = 300kHz$
- Set to PWM mode by default

1.3 Ordering Information

Part Number	Description
ISL8215MEVAL1Z	ISL8215M single 15A power module evaluation board

1.4 Related Literature

- For a full list of related documents, visit our website
- [ISL8215M](#) product page

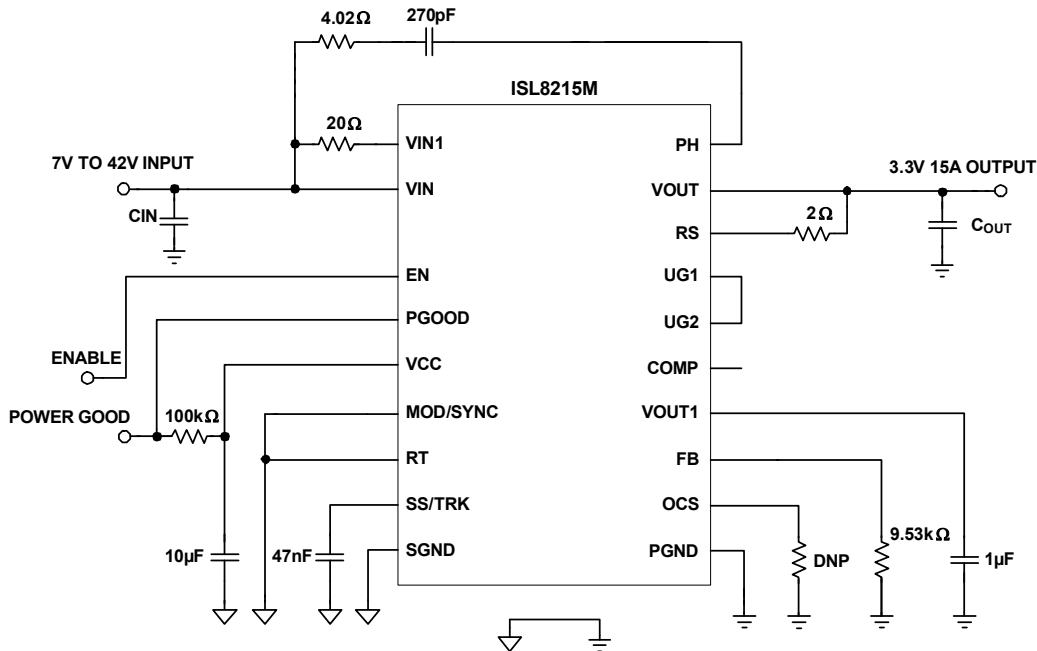

Figure 1. ISL8215MEVAL1Z Block Diagram

1.5 Recommended Testing Equipment

- 0V to 42V power supply with at least 12A source current capability
- Electronic loads capable of sinking current up to 15A
- Digital Multimeters (DMMs)
- Oscilloscope with higher than 100MHz bandwidth

2. Functional Description

The ISL8215MEVAL1Z provides the peripheral circuitry to evaluate the feature set of the ISL8215M. The evaluation board is designed with mechanical switches for ENABLE, several connectors, test points, and jumpers, which makes validation of the module easy. The converter can be enabled and disabled by toggling the ENABLE switch as shown in [Figure 2 on page 6](#). Connecting a jumper across the pins as shown in [Figure 2](#) enables the PSM/DEM mode of operation, which can lead to higher efficiencies at light loads. Selecting features like external frequency synchronization can be performed by hooking the signal generator (square pulse waveform clock signal) to the MOD/SYNC pin. The output voltage (0.6V - 12V) and the switching frequency (300kHz to 2MHz) can be programmed by changing the resistors as shown in [Figure 3 on page 6](#).

2.1 Quick Test Guide

- (1) Disable the module by toggling the ENABLE switch as shown in [Figure 2 on page 6](#).
- (2) Use the appropriate cables to connect the DC input power supply to banana sockets J1 and J4 and the electronic load to sockets J3 and J2. Ensure that the polarity for the power leads is correct and the input voltage is within the operating range (7V - 42V) of the module. Use test points TP1 (VIN) and TP2 (PGND) for accurately measuring the input voltage.
- (3) Turn on the input power supply.
- (4) Turn the ENABLE switch to position “SW1 ENABLE” for enabling the module.
- (5) Probe test points TP3 (VOUT) and TP4 (PGND) to observe the output voltage. The output voltage should read 3.3V.
- (6) Adjust input voltage, V_{IN} , within the specified range and observe output voltage. The output voltage variation should be within $\pm 1.5\%$.
- (7) Adjust the load current to within the specified range (0 - 15A) and observe output voltage. The output voltage variation should be within $\pm 1.5\%$.
- (8) To change V_{OUT} , disconnect the evaluation board from the setup and populate a standard 0603 resistor at the R_2 placeholder location on the bottom layer. The “Output Voltage Resistor Settings” table in the [ISL8215M](#) datasheet can be used as a reference for programming different output voltages. Refer to the “ISL8215M Design Guide Matrix” table in the [ISL8215M](#) datasheet for correct input and output capacitors, switching frequency, and output voltage combinations.
- (9) The switching frequency can be modified by populating a standard 0603 resistor at the R_{11} placeholder location on the bottom layer. Refer to “Equation 2” in the [ISL8215M](#) datasheet for selecting the correct value of R_{11} within admissible operating range (300kHz - 2MHz).

2.2 Thermal Considerations and Current Derating

Board layout is very critical so that the module can operate safely and deliver the maximum allowable power. For the board to operate properly at high ambient temperature environments and carry full load current, the board layout needs to be carefully designed to maximize thermal performance. To achieve this, use enough trace width, copper weight, and proper connectors.

The ISL8215MEVAL1Z evaluation board is capable of operating at 15A full load current at room temperature without the need for additional cooling systems. However, if the board is to operate at elevated ambient temperatures, then the available output current may need to be derated. Refer to the derated current curves in the [ISL8215M](#) datasheet to determine the maximum output current the evaluation board can supply.

3. PCB Layout Guidelines

The ISL8215MEVAL1Z evaluation board is a 1.8in x 3in four-layer FR-4 board with 2oz. copper on all the layers. The board can be used as a single 15A reference design. Refer to [Figures 15](#) through [20](#) for board layout information.

The ISL8215MEVAL1Z board layout has been optimized for electrical performance, low loss, and good thermal performance. Similar performance can be obtained for designs involving ISL8215M, while adhering to the following layout design tips:

3.1 Layout Considerations

- (1) The input capacitors and high frequency decoupling ceramic capacitors are placed between VIN and PGND, as close to the module as possible. The loop formed by the input capacitor, VIN pad, and PGND is kept as small as possible, to minimize the high frequency noise. The output capacitors are placed closer towards the load. Short, wide copper planes are used to connect the output capacitors to the load for avoiding any parasitic inductances and resistances.
- (2) Large copper planes are used for VIN, VOUT, and PGND to minimize conduction loss and thermal stress. Multiple vias are used to connect the power planes in different layers.
- (3) Ground planes are used in the internal layers (Layer 2 and Layer 3) with shared SGND and PGND to simplify the layout design. The controller SGND has a solid connection to the PGND through multiple vias. The bottom layer is used to route EN and VCC signals. PGOOD is routed on the top layer.
- (4) For achieving a tight output voltage regulation, the V_{OUT+} point is connected to the Remote Sense (RS) pin by routing the trace through inner Layer 3. A 2Ω resistor is placed close to the RS pin for damping the noise on the traces.
- (5) To avoid ground bouncing issues, place the V_{IN} return and the V_{OUT} return diagonally opposite to each other. This ensures that the switching noise generated by the power-train will have a minimal effect on the controller operation.
- (6) Because the phase nodes are subjected to very high dv/dt voltages, the parasitic capacitor formed between these islands and the surrounding circuitry will tend to couple the switching noise. The PHASE node is placed in Layer 3 and the bottom layer of the PCB to minimize its impact on the operation of the controller. The sensitive signal traces (EN, VCC, and PGOOD) are routed away from the PHASE node plane to minimize noise coupling.
- (7) The VCC bypass capacitor is placed underneath the VCC pin, and its ground is connected to the PGND pad. The low-side feedback resistor, R₂, and the decoupling capacitor, C₂₅, are connected to the SGND pad through multiple vias.
- (8) For a switching frequency of 300kHz, a 4.02Ω 1206 resistor and a 270pF 100V X7R 0603 capacitor in series from PH to VIN is required. De-rate the resistor size for switching frequencies higher than 300kHz. Calculate the power dissipated in resistor (P_{cal}) by using the formula $C \cdot V^2 \cdot f$, where,
 - C = 270pF
 - V = Input voltage
 - f = Frequency of operation.

For derating purposes, the nominal power handling capability of the resistor package size should be at least P_{cal}/0.65. The 65% derating is derived by looking at the resistor operation at +100°C ambient temperature. Use a standard thick film chip resistor datasheet to find the correct resistor package size for different switching frequencies and input voltage.

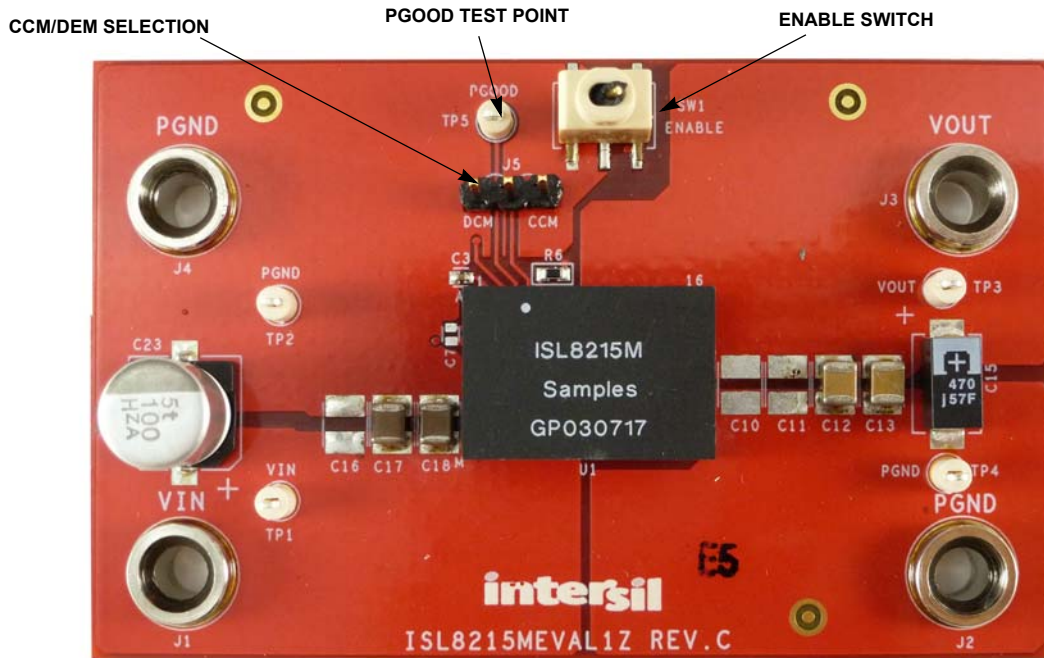

Figure 2. Top of Board

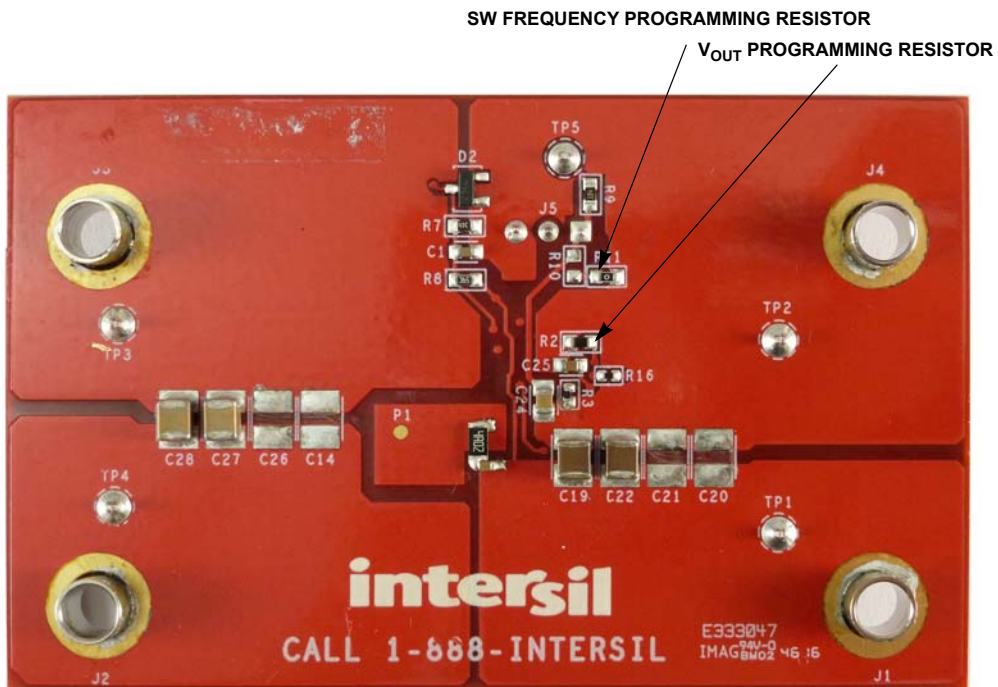

Figure 3. Bottom of Board

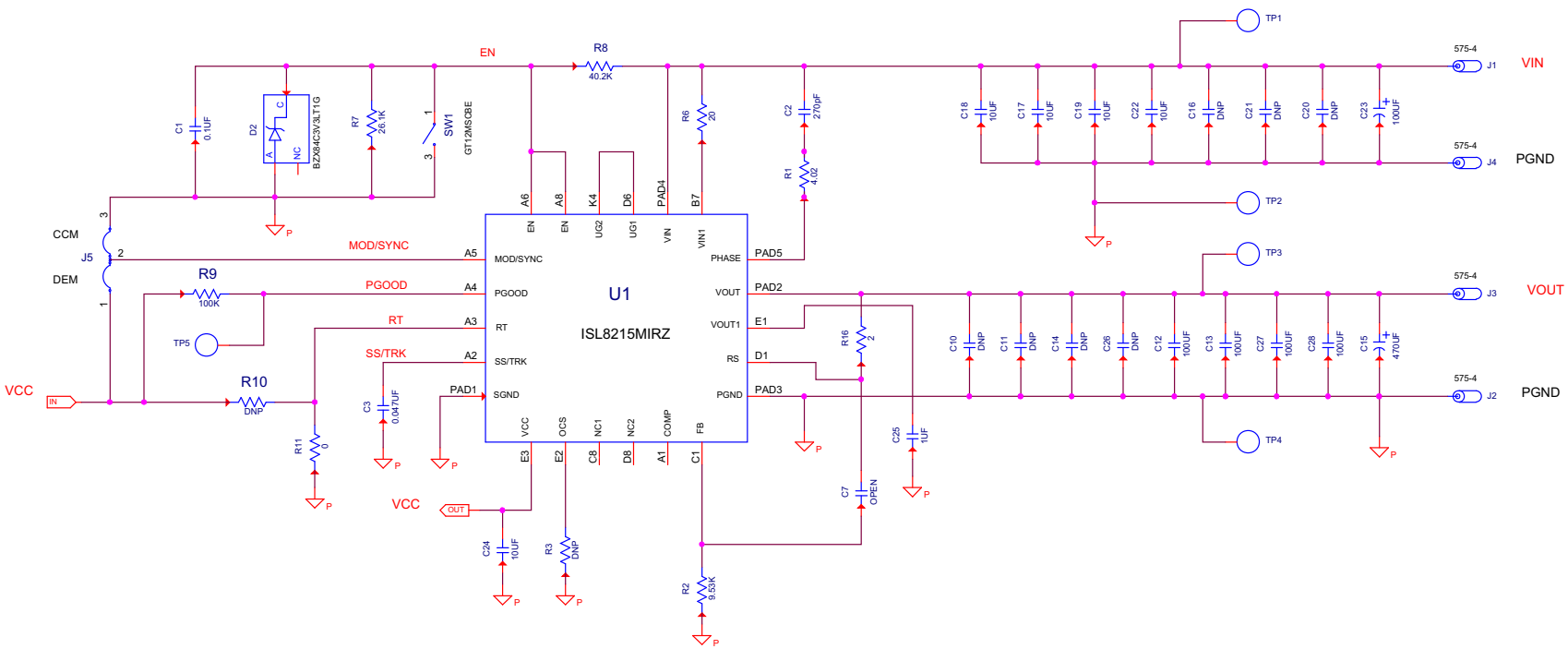

Figure 4. Schematic

3.2 ISL8215MEVAL1Z Schematic

3.3 Typical Evaluation Board Performance Curves

The following data was acquired using the ISL8215MEVAL1Z evaluation board at +25°C ambient and free air 0LFM.

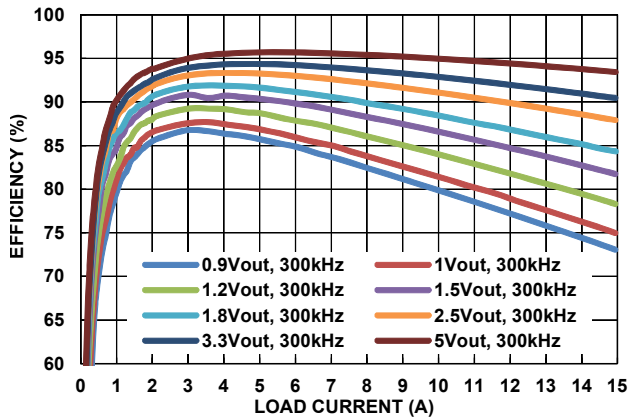

Figure 5. Efficiency vs Load Current at $V_{IN} = 12V$, CCM Mode

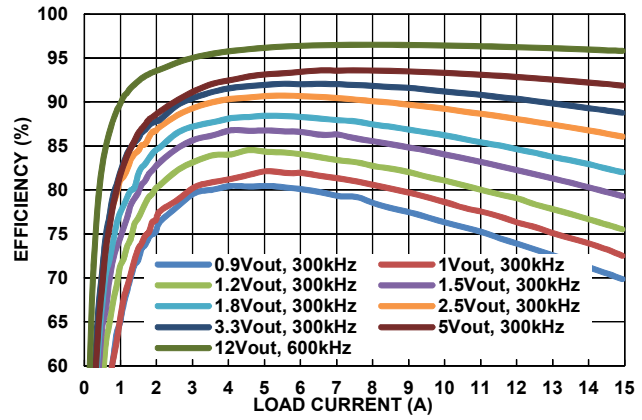

Figure 6. Efficiency vs Load Current at $V_{IN} = 24V$, CCM Mode

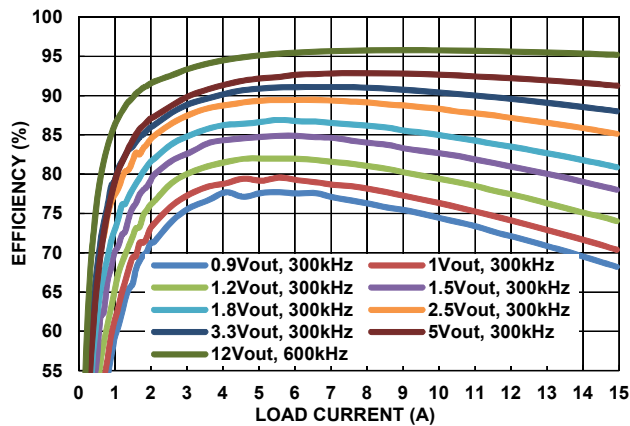

Figure 7. Efficiency vs Load Current at $V_{IN} = 30V$, CCM Mode

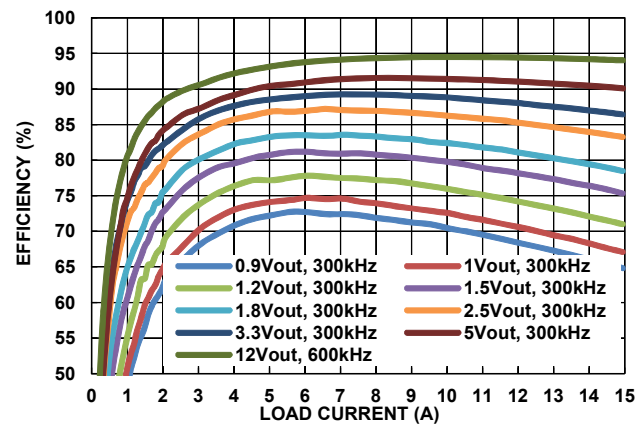

Figure 8. Efficiency vs Load Current at $V_{IN} = 42V$, CCM Mode

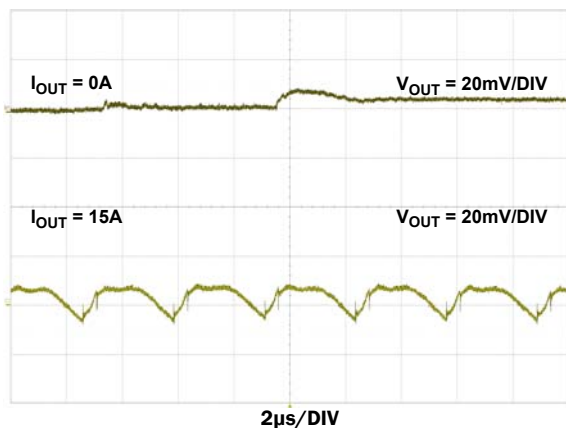

Figure 9. Output Ripple, $V_{IN} = 24V$, $V_{OUT} = 3.3V$, PSM/DEM Mode, $C_{OUT} = 4 \times 100\mu F$ Ceramic + $1 \times 470\mu F$ POSCAP

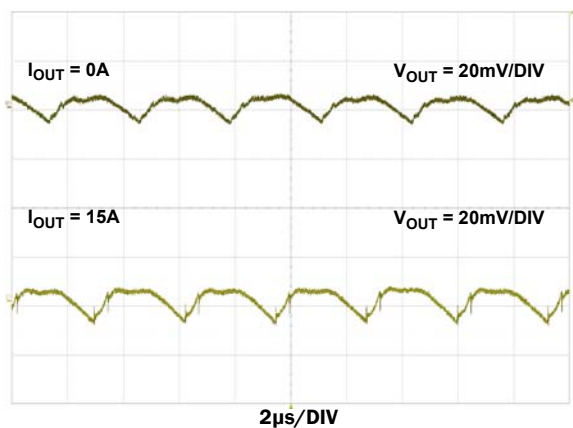

Figure 10. Output Ripple, $V_{IN} = 24V$, $V_{OUT} = 3.3V$, $f_{SW} = 300kHz$, CCM Mode, $C_{OUT} = 4 \times 100\mu F$ Ceramic + $1 \times 470\mu F$ POSCAP

3.4 Typical Evaluation Board Performance Data

Operating condition: $V_{IN} = 24V$, $f_{SW} = 300kHz$, CCM Mode, unless otherwise noted.

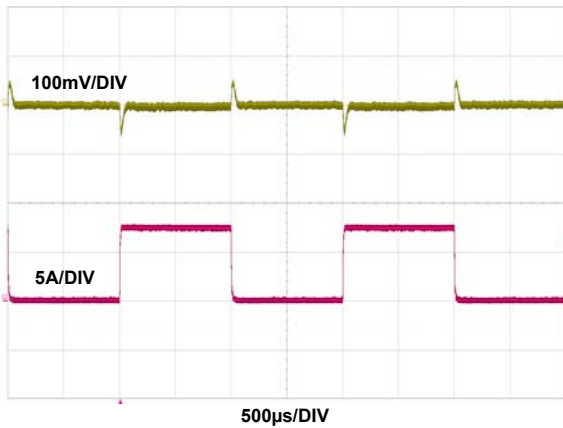

Figure 11. Transient Response, $V_{OUT} = 3.3V$, 0A to 7.5A, 2.5A/ μs Step Load, $C_{OUT} = 4 \times 100\mu F$ Ceramic + 1x470 μF POSCAP

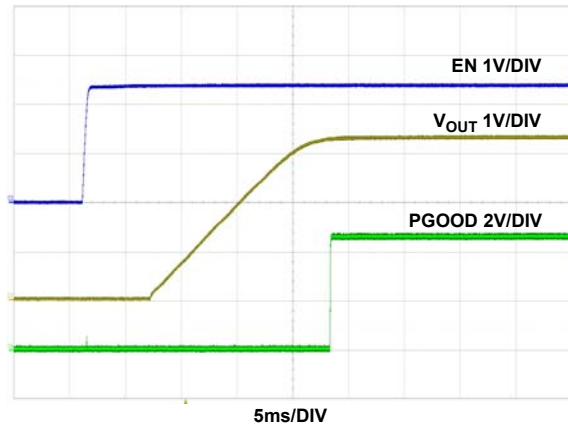

Figure 12. Start-Up Waveform, $V_{OUT} = 3.3V$, $I_{OUT} = 15A$, $C_{OUT} = 4 \times 100\mu F$ Ceramic + 1x470 μF POSCAP

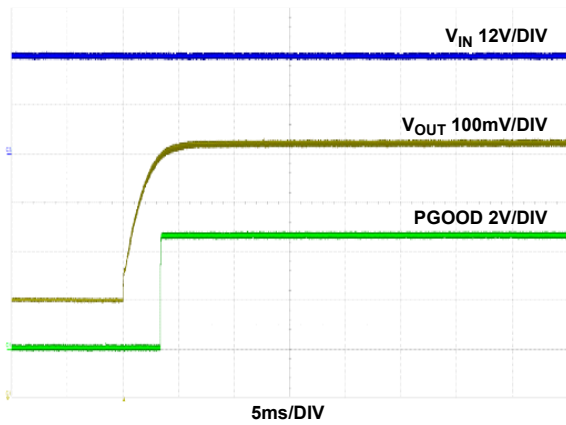

Figure 13. Prebiased Power-Up Waveform, Prebiased Voltage = 3.0V, $V_{OUT} = 3.3V$, $I_{OUT} =$ No Load, $C_{OUT} = 4 \times 100\mu F$ Ceramic + 1x470 μF POSCAP

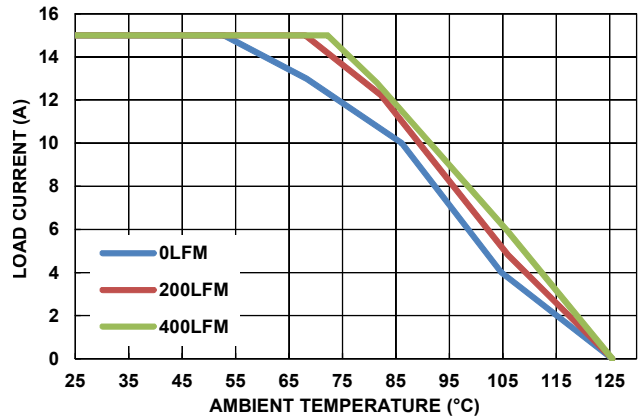

Figure 14. Derating Curve, $V_{OUT} = 3.3V$, $C_{OUT} = 4 \times 100\mu F$ Ceramic + 1x470 μF POSCAP

3.5 Bill of Materials

Reference Designators	Qty	Value	Tol.	Voltage	Power	Package Type	Manufacturer	Part Number	Description
C15	1	470 μ F	\pm 20%	6.3V		2917	Panasonic	6TPF470MAH	POSCAP
C12, C13, C27, C28	4	100 μ F	\pm 20%	10V		1210	Murata	LMK325BJ107MM-T	Ceramic Capacitor
C10, C11, C14, C26	4	OPEN	\pm 20%	10V		1210	Murata	LMK325BJ107MM-T	Ceramic Capacitor
C17, C18, C19, C22	4	10 μ F	\pm 10 %	50V		1210	Murata	GRM32ER71H106KA12L-T	Ceramic Capacitor
C16, C20, C21	3	OPEN	\pm 10 %	50V		1210	Murata	GRM32ER71H106KA12L-T	Ceramic Capacitor
C23	1	100 μ F	\pm 20%	50V		Radial, Can - SMD	United Chemi-Con	EMZA500ADA101MHA0G	Aluminum Electrolytic Capacitor
C3	1	0.047 μ F	\pm 5%	25V		0402	Kemet	C0402C473J3RAC7867	Multilayer Capacitor
C25	1	1.0 μ F	\pm 10%	25V		0603	Murata	GRM188R71E105KA12D	Ceramic Chip Capacitor
C7	1	OPEN	\pm 10%	25V		0402	Generic		Multilayer Capacitor
C1	1	0.1 μ F	\pm 10%	25V		0603	Murata	GRM188R71E104KA01D	Ceramic Capacitor
C2 (Note 1)	1	270pF	\pm 10%	100V		0603	Murata	GRM188R72A271KA01D	Ceramic Capacitor
C24	1	10 μ F	\pm 10%	25V		0805	TDK	C2012X5R1E106K	Multilayer Capacitor
J1-J4	4					CONN-JACK	Keystone	575-4	Solder Mount Banana Jack
TP1-TP5	5					CONN-MINI TEST POINT	Keystone	5002	Miniature PC Test Point
J5	1					CONN-HEADER	FCI/Amphenol	68000-236HLF	Three Pin Jumper
SW1	1					SMD	C&K Componenets	GT12MSCBE	SPDT ON/OFF Toggle Switch
D2	1		\pm 6%	3.3V	225mW	SOT-23-3	On-Semi	BZX84C3V3LT1G	Zener Diodes
U1	1					19X13 HDA	Intersil	ISL8215MIRZ	IC-42V 15A Step-Down Power Module
R1 (Note 1)	1	4.02 Ω	\pm 1%		1/4W	1206	Yageo	RC1206FR-074R02L	Chip Resistor
R2	1	9.53k Ω	\pm 1%		1/10W	0603	Venkel	CR0603-10W-9531FT	Thick Film Chip Resistor

Reference Designators	Qty	Value	Tol.	Voltage	Power	Package Type	Manufacturer	Part Number	Description
R10	1	DNP	±1%		1/10W	0603			Metal Film Chip Resistor
R3	1	475kΩ	±1%		1/16W	0402	Yageo	RC0402FR-07475KL	Chip Resistor
R6	1	20Ω	±1%		1/10W	0603	Panasonic	ERJ-3EKF20R0V	Chip Resistor
R11	1	0Ω			1/10W	0603	Venkel	CR0603-10W-000T	Chip Resistor
R9	1	100kΩ	±1%		1/10W	0603	Venkel	CR0603-10W-1003FT	Chip Resistor
R7	1	26.1kΩ	±1%		1/10W	0603	Yageo	9C06031A2612FKHFT	Chip Resistor
R8	1	40.2kΩ	±1%		1/10W	0603	Yageo	RC0603FR-0740K2L	Chip Resistor
R16	1	2Ω	±1%		1/16W	0402	Venkel	CR0402-16W-02R0FT	Chip Resistor

Note:

1. R1 and C2 do not have a reference designator or footprint on the evaluation board. The resistor and capacitor are soldered on the bottom of the PCB.

3.6 ISL8215MEVAL1Z PCB Layout

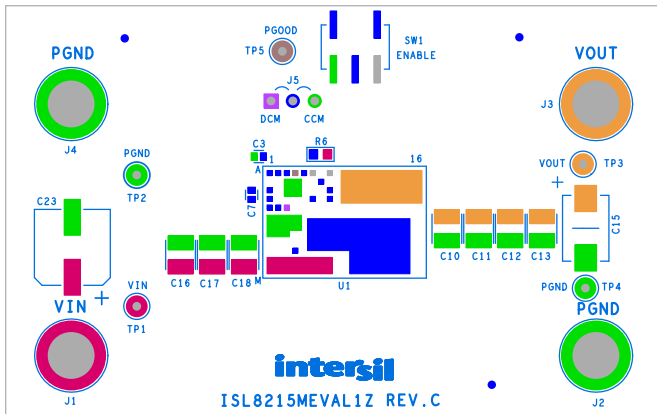

Figure 15. Silkscreen Top

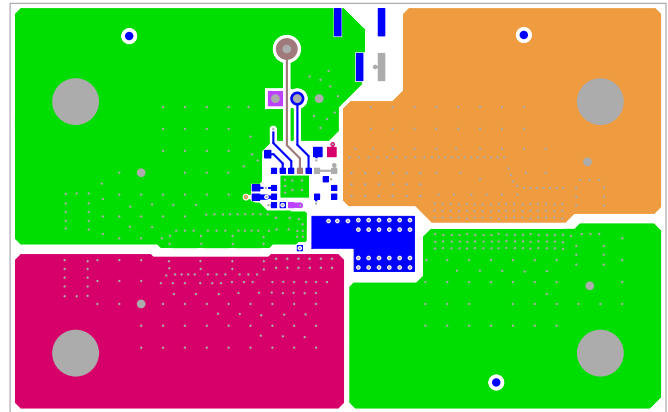

Figure 16. Top Layer Component Side

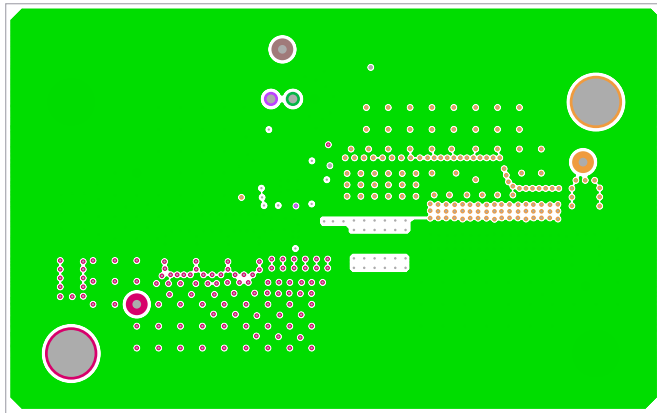

Figure 17. Inner Layer 2

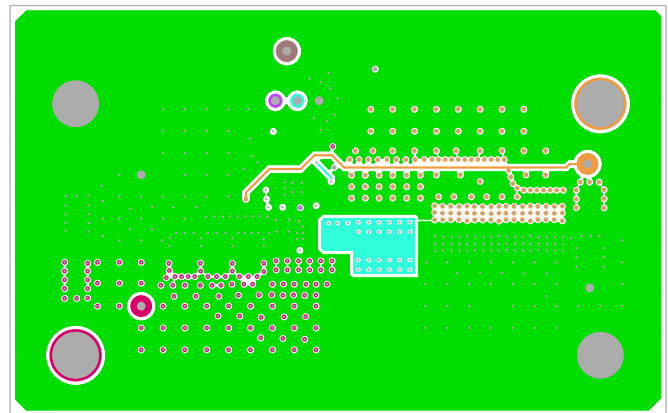

Figure 18. Inner Layer 3

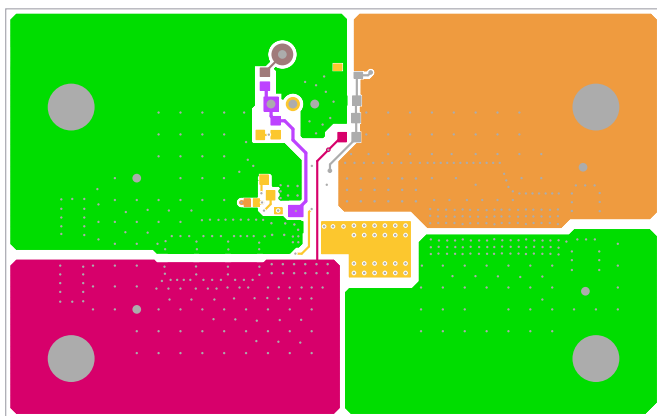

Figure 19. Bottom Layer Solder Side

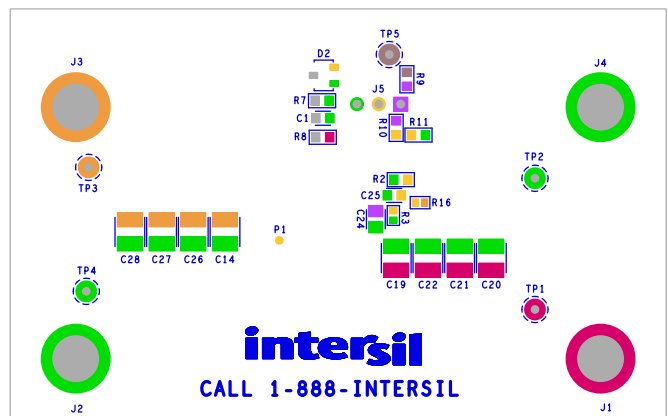

Figure 20. Silkscreen Bottom

4. Revision History

Rev.	Date	Description
0.00	Aug 14, 2017	Initial release

Notice

1. Descriptions of circuits, software and other related information in this document are provided only to illustrate the operation of semiconductor products and application examples. You are fully responsible for the incorporation or any other use of the circuits, software, and information in the design of your product or system. Renesas Electronics disclaims any and all liability for any losses and damages incurred by you or third parties arising from the use of these circuits, software, or information.
 2. Renesas Electronics hereby expressly disclaims any warranties against and liability for infringement or any other claims involving patents, copyrights, or other intellectual property rights of third parties, by or arising from the use of Renesas Electronics products or technical information described in this document, including but not limited to, the product data, drawings, charts, programs, algorithms, and application examples.
 3. No license, express, implied or otherwise, is granted hereby under any patents, copyrights or other intellectual property rights of Renesas Electronics or others.
 4. You shall not alter, modify, copy, or reverse engineer any Renesas Electronics product, whether in whole or in part. Renesas Electronics disclaims any and all liability for any losses or damages incurred by you or third parties arising from such alteration, modification, copying or reverse engineering.
 5. Renesas Electronics products are classified according to the following two quality grades: "Standard" and "High Quality". The intended applications for each Renesas Electronics product depends on the product's quality grade, as indicated below.
"Standard": Computers; office equipment; communications equipment; test and measurement equipment; audio and visual equipment; home electronic appliances; machine tools; personal electronic equipment; industrial robots; etc.
"High Quality": Transportation equipment (automobiles, trains, ships, etc.); traffic control (traffic lights); large-scale communication equipment; key financial terminal systems; safety control equipment; etc.
Unless expressly designated as a high reliability product or a product for harsh environments in a Renesas Electronics data sheet or other Renesas Electronics document, Renesas Electronics products are not intended or authorized for use in products or systems that may pose a direct threat to human life or bodily injury (artificial life support devices or systems; surgical implantations; etc.), or may cause serious property damage (space system; undersea repeaters; nuclear power control systems; aircraft control systems; key plant systems; military equipment; etc.). Renesas Electronics disclaims any and all liability for any damages or losses incurred by you or any third parties arising from the use of any Renesas Electronics product that is inconsistent with any Renesas Electronics data sheet, user's manual or other Renesas Electronics document.
 6. When using Renesas Electronics products, refer to the latest product information (data sheets, user's manuals, application notes, "General Notes for Handling and Using Semiconductor Devices" in the reliability handbook, etc.), and ensure that usage conditions are within the ranges specified by Renesas Electronics with respect to maximum ratings, operating power supply voltage range, heat dissipation characteristics, installation, etc. Renesas Electronics disclaims any and all liability for any malfunctions, failure or accident arising out of the use of Renesas Electronics products outside of such specified ranges.
 7. Although Renesas Electronics endeavors to improve the quality and reliability of Renesas Electronics products, semiconductor products have specific characteristics, such as the occurrence of failure at a certain rate and malfunctions under certain use conditions. Unless designated as a high reliability product or a product for harsh environments in a Renesas Electronics data sheet or other Renesas Electronics document, Renesas Electronics products are not subject to radiation resistance design. You are responsible for implementing safety measures to guard against the possibility of bodily injury, injury or damage caused by fire, and/or danger to the public in the event of a failure or malfunction of Renesas Electronics products, such as safety design for hardware and software, including but not limited to redundancy, fire control and malfunction prevention, appropriate treatment for aging degradation or any other appropriate measures. Because the evaluation of microcomputer software alone is very difficult and impractical, you are responsible for evaluating the safety of the final products or systems manufactured by you.
 8. Please contact a Renesas Electronics sales office for details as to environmental matters such as the environmental compatibility of each Renesas Electronics product. You are responsible for carefully and sufficiently investigating applicable laws and regulations that regulate the inclusion or use of controlled substances, including without limitation, the EU RoHS Directive, and using Renesas Electronics products in compliance with all these applicable laws and regulations. Renesas Electronics disclaims any and all liability for damages or losses occurring as a result of your noncompliance with applicable laws and regulations.
 9. Renesas Electronics products and technologies shall not be used for or incorporated into any products or systems whose manufacture, use, or sale is prohibited under any applicable domestic or foreign laws or regulations. You shall comply with any applicable export control laws and regulations promulgated and administered by the governments of any countries asserting jurisdiction over the parties or transactions.
 10. It is the responsibility of the buyer or distributor of Renesas Electronics products, or any other party who distributes, disposes of, or otherwise sells or transfers the product to a third party, to notify such third party in advance of the contents and conditions set forth in this document.
 11. This document shall not be reprinted, reproduced or duplicated in any form, in whole or in part, without prior written consent of Renesas Electronics.
 12. Please contact a Renesas Electronics sales office if you have any questions regarding the information contained in this document or Renesas Electronics products.
- (Note 1) "Renesas Electronics" as used in this document means Renesas Electronics Corporation and also includes its directly or indirectly controlled subsidiaries.
(Note 2) "Renesas Electronics product(s)" means any product developed or manufactured by or for Renesas Electronics.

(Rev.4.0-1 November 2017)



SALES OFFICES

Renesas Electronics Corporation

<http://www.renesas.com>

Refer to "<http://www.renesas.com/>" for the latest and detailed information.

Renesas Electronics America Inc.
1001 Murphy Ranch Road, Milpitas, CA 95035, U.S.A.
Tel: +1-408-432-8888, Fax: +1-408-434-5351

Renesas Electronics Canada Limited
9251 Yonge Street, Suite 8309 Richmond Hill, Ontario Canada L4C 9T3
Tel: +1-905-237-2004

Renesas Electronics Europe Limited
Dukes Meadow, Millboard Road, Bourne End, Buckinghamshire, SL8 5FH, U.K.
Tel: +44-1628-651-700, Fax: +44-1628-651-804

Renesas Electronics Europe GmbH
Arcadiastrasse 10, 40472 Düsseldorf, Germany
Tel: +49-211-6503-0, Fax: +49-211-6503-1327

Renesas Electronics (China) Co., Ltd.
Room 1709 Quantum Plaza, No.27 ZhichunLu, Haidian District, Beijing, 100191 P. R. China
Tel: +86-10-8235-1155, Fax: +86-10-8235-7679

Renesas Electronics (Shanghai) Co., Ltd.
Unit 301, Tower A, Central Towers, 555 Langao Road, Putuo District, Shanghai, 200333 P. R. China
Tel: +86-21-2226-0888, Fax: +86-21-2226-0999

Renesas Electronics Hong Kong Limited
Unit 1601-1611, 16/F., Tower 2, Grand Century Place, 193 Prince Edward Road West, Mongkok, Kowloon, Hong Kong
Tel: +852-2265-6688, Fax: +852-2886-9022

Renesas Electronics Taiwan Co., Ltd.
13F, No. 363, Fu Shing North Road, Taipei 10543, Taiwan
Tel: +886-2-8175-9600, Fax: +886-2-8175-9670

Renesas Electronics Singapore Pte. Ltd.
80 Bendemeer Road, Unit #06-02 Hyflux Innovation Centre, Singapore 339949
Tel: +65-6213-0200, Fax: +65-6213-0300

Renesas Electronics Malaysia Sdn.Bhd.
Unit 1207, Block B, Menara Amcorp, Amcorp Trade Centre, No. 18, Jln Persiaran Barat, 46050 Petaling Jaya, Selangor Darul Ehsan, Malaysia
Tel: +60-3-7955-9390, Fax: +60-3-7955-9510

Renesas Electronics India Pvt. Ltd.
No.777C, 100 Feet Road, HAL 2nd Stage, Indiranagar, Bangalore 560 038, India
Tel: +91-80-67208700, Fax: +91-80-67208777

Renesas Electronics Korea Co., Ltd.
17F, KAMCO Yangjae Tower, 262, Gangnam-daero, Gangnam-gu, Seoul, 06265 Korea
Tel: +82-2-558-3737, Fax: +82-2-558-5338

ISL8215MEVAL1Z

