

**FEATURES**

Fully certified DO-160G EMC protection on RS-485 bus pins:
Section 22 lightning protection Waveform 3, Waveform 4/
Waveform 1, and Waveform 5A pin injection, Level 4
protection

DO-160G Section 25 ESD protection: ± 15 kV air discharge
RS-485 A Pin and RS-485 B pin and HBM ESD protection:
 $> \pm 30$ kV

± 42 V ac/dc peak fault protection on RS-485 bus pins

TIA/EIA RS-485 compliant over full supply range
3.0 V to 5.5 V operating voltage range on V_{CC}
1.62 V to 5.5 V V_{IO} logic supply

Common-mode input range: -25 V to $+25$ V

2.5 Mbps data rate, maximum

Half duplex

Enhanced 2.1 V driver output strength at 4.5 V V_{CC}

Receiver short-circuit, open circuit, and floating input fail-safe

Supports 256 bus nodes (96 k Ω receiver input resistance)
 -55°C to $+125^{\circ}\text{C}$ temperature option

Glitch free power-up and power-down (hot swap)

16-lead, narrow body SOIC package

ENHANCED PRODUCT FEATURES

Supports defense and aerospace applications
(AQEC standard)

Military -55°C to $+125^{\circ}\text{C}$ operating temperature range

Controlled manufacturing baseline

1 assembly/test site

Enhanced product change notification

Qualification data available on request

APPLICATIONS

**Military and aerospace (MILA) avionics for sensors,
actuators, and engine control**

GENERAL DESCRIPTION

The ADM3095E-EP is a 3.0 V to 5.5 V, 2.5 Mbps, RS-485 transceiver that features up to ± 42 V ac/dc peak bus overvoltage fault protection on the RS-485 bus pins. This device is designed to withstand overvoltage faults, such as short circuits directly to power supplies, and overvoltage faults, such as ± 24 V ac supplies connected in error to the RS-485 A and B bus pins. The ADM3095E-EP integrates fully certified DO-160G electromagnetic capability (EMC) protection on the RS-485 bus pins, with Section 22 lightning protection. The ADM3095E-EP also provides Section 25 ± 15 kV electrostatic discharge (ESD) air discharge protection. For Section 22 lightning, the ADM3095E-EP provides protection for Waveform 3, Waveform 4/Waveform 1, and Waveform 5A to Level 4 connecting 33 Ω or 47 Ω current limiting resistors to GND.

This device has an extended common-mode input voltage (V_{CM}) range of ± 25 V to improve data communication reliability in noisy environments over long cable lengths where ground loop voltages are possible. The combination of extended common-mode input voltage range, overvoltage fault protection, and DO-160 EMC protection make the ADM3095E-EP a completely integrated EMC protected RS-485 transceiver.

The ADM3095E-EP also features a logic supply pin, V_{IO} , for a flexible digital interface, operational to voltages as low as 1.62 V. The ADM3095E-EP features a high driver differential output voltage, V_{OD} , of 2.1 V minimum at power supply voltages greater than 4.5 V. The device is fully characterized over extended operating temperature ranges, with options of -55°C to $+125^{\circ}\text{C}$, and is available in a 16-lead, narrow body SOIC package.

Additional information and technical information can be found in the [ADM3095E](#) data sheet.

TABLE OF CONTENTS

Features	1	ESD Caution.....	6
Enhanced Product Features	1	Pin Configuration and Function Descriptions.....	7
Applications.....	1	Typical Performance Characteristics	8
General Description	1	Test Circuits.....	11
Revision History	2	Theory of Operation	12
Functional Block Diagram	3	Certified DO-160G EMC Protection	12
Specifications.....	4	DO-160G ADM3095E-EP Test Details.....	12
Timing Specifications	5	Outline Dimensions	14
Timing Diagrams.....	5	Ordering Guide	14
Absolute Maximum Ratings.....	6		
Thermal Resistance	6		

REVISION HISTORY

9/2017—Revision 0: Initial Version

FUNCTIONAL BLOCK DIAGRAM

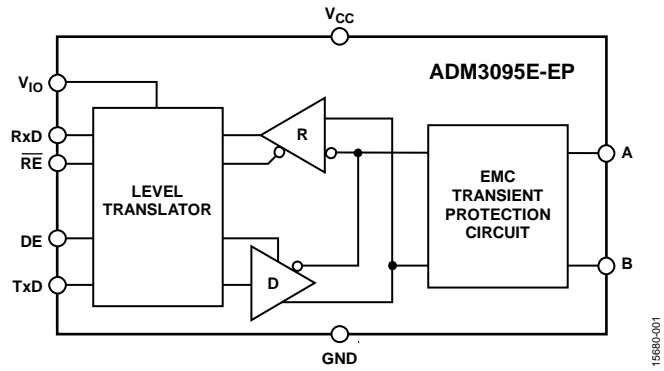

Figure 1. Functional Block Diagram

15680-001

SPECIFICATIONS

$V_{CC} = 3.0\text{ V}$ to 5.5 V , $T_A = -55^\circ\text{C}$ (T_{MIN}) to 125°C (T_{MAX}), unless otherwise noted.

Table 1.

Parameter	Min	Typ	Max	Unit	Test Conditions/Comments
DRIVER					
Differential Output Voltage (V_{OD})	1.5		5.0	V	$V_{CC} \geq 3.0\text{ V}$, $R = 27\ \Omega$ or $50\ \Omega$; see Figure 25
	2.1		5.0	V	$V_{CC} \geq 4.5\text{ V}$, $R = 27\ \Omega$ or $50\ \Omega$; see Figure 25
Differential Output Voltage over Common Mode Range [V_{OD3}]	1.5		5.0	V	$V_{CC} \geq 3.0\text{ V}$, $V_{CM} = -25\text{ V}$ to $+25\text{ V}$; see Figure 26
	2.1		5.0	V	$V_{CC} \geq +4.5\text{ V}$, $V_{CM} = -25\text{ V}$ to $+25\text{ V}$; see Figure 26
$\Delta V_{OD} $ for Complementary Output States			0.2	V	$R = 27\ \Omega$ or $50\ \Omega$; see Figure 25
Common-Mode Output Voltage (V_{OC})			3	V	$R = 27\ \Omega$ or $50\ \Omega$; see Figure 25
$\Delta V_{OC} $ for Complementary Output States			0.2	V	$R = 27\ \Omega$ or $50\ \Omega$; see Figure 25
Output Short-Circuit Current (V_{OUT})					
High	-250		+250	mA	$-42\text{ V} \leq V_{SC}^1 \leq +42\text{ V}$
Low	-250		+250	mA	$-42\text{ V} \leq V_{SC}^1 \leq +42\text{ V}$
DRIVER INPUT LOGIC					
Input Logic Threshold Low			$0.33 V_{IO}$	V	$1.62\text{ V} \leq V_{IO} \leq 5.5\text{ V}$
Input Logic Threshold High	$0.7 V_{IO}$			V	$1.62\text{ V} \leq V_{IO} \leq 5.5\text{ V}$
Logic Input Current			± 1	μA	$0 \leq V_{IN} \leq V_{IO}$
RECEIVER					
Differential Input Threshold Voltage (V_{TH})	-200	-125	-30	mV	$-25\text{ V} \leq V_{CM} \leq +25\text{ V}$
Input Hysteresis (ΔV_{TH})		30		mV	$-25\text{ V} \leq V_{CM} \leq +25\text{ V}$
Input Resistance (A, B)	96			k Ω	$-25\text{ V} \leq V_{CM} \leq +25\text{ V}$
Input Capacitance (A, B)		150		pF	$T_A = 25^\circ\text{C}$
Input Current (A, B)	-1.0		+1.0	mA	$DE = 0\text{ V}$, $V_{CC} = 0\text{ V}$ or $+5\text{ V}$, $V_{IN} = \pm 25\text{ V}$
	-1.0		+1.0	mA	$DE = 0\text{ V}$, $V_{CC} = 0\text{ V}$ or $+5\text{ V}$, $V_{IN} = \pm 42\text{ V}$
CMOS Logic Input Current (\overline{RE})			± 1	μA	
Output Voltage					
Low (V_{OL})			0.2	V	$I_{OUT} = 300\ \mu\text{A}$
High (V_{OH})	$V_{IO} - 0.2$			V	$V_{IO} \geq +1.62\text{ V}$, $I_{OUT} = -300\ \mu\text{A}$
Output Short-Circuit Current	4		85	mA	$V_{OUT} = \text{GND}$ or V_{IO} , $\overline{RE} = 0\text{ V}$, $V_{IO} \geq 3.0\text{ V}$
			85	mA	$V_{OUT} = \text{GND}/V_{IO}$, $\overline{RE} = 0\text{ V}$, $V_{IO} < 3.0\text{ V}$
Three-State Output Leakage Current			± 2	μA	$\overline{RE} = V_{IO}$, $RxD = 0\text{ V}$ or V_{IO}
POWER SUPPLY					
V_{IO}	1.62		V_{CC}	V	
Supply Current (I_{CC})					
			8	mA	No load, $DE = V_{CC} = V_{IO}$, $\overline{RE} = 0\text{ V}$
TxD Data Rate = 2.5 Mbps			50	mA	No load, $DE = V_{CC} = V_{IO}$, $\overline{RE} = V_{CC} = V_{IO}$
RxD Data Rate = 2.5 Mbps			6	mA	No load, $DE = 0\text{ V}$, $\overline{RE} = 0\text{ V}$
TxD/RxD Data Rate = 2.5 Mbps			90	mA	No load, $DE = V_{CC} = V_{IO}$, $\overline{RE} = 0\text{ V}$
TxD/RxD Data Rate = 2.5 Mbps			130	mA	$R_L = 54\ \Omega$, $DE = V_{CC} = V_{IO}$, $\overline{RE} = 0\text{ V}$
			90	mA	$R_L = 54\ \Omega$, $DE = V_{CC} = V_{IO}$, $\overline{RE} = 0\text{ V}$, $V_{CC} = 5.5\text{ V}$
			45	mA	$R_L = 54\ \Omega$, $DE = V_{CC} = V_{IO}$, $\overline{RE} = 0\text{ V}$, $V_{CC} = 3.0\text{ V}$
Supply Current in Shutdown Mode			5	μA	$DE = 0\text{ V}$, $\overline{RE} = V_{CC} = V_{IO}$

¹ V_{SC} is the short-circuit voltage at the RS-485 A or B bus pin.

TIMING SPECIFICATIONS

$V_{CC} = 3.0\text{ V to }5.5\text{ V}$, $V_{IO} = 1.62\text{ V to }V_{CC}$, $T_A = -55^\circ\text{C (T}_{MIN})\text{ to }125^\circ\text{C (T}_{MAX})$, unless otherwise noted.

Table 2.

Parameter	Min	Typ	Max	Unit	Test Conditions/Comments
DRIVER					
Data Rate			2.5	Mbps	
Propagation Delay (t_{PLH} , t_{PHL})		35	500	ns	$R_{LDIFF} = 54\ \Omega$, $C_{L1} = C_{L2} = 100\text{ pF}$; see Figure 2 and Figure 27
Differential Skew (t_{SKEW})		10	50	ns	$R_{LDIFF} = 54\ \Omega$, $C_{L1} = C_{L2} = 100\text{ pF}$; see Figure 2 and Figure 27
Rise/Fall Times (t_r , t_f)		40	130	ns	$R_{LDIFF} = 54\ \Omega$, $C_{L1} = C_{L2} = 100\text{ pF}$; see Figure 2 and Figure 27
Enable Time (t_{ZH} , t_{ZL})		500	2500	ns	$R_L = 110\ \Omega$, $C_L = 50\text{ pF}$; see Figure 4 and Figure 28
Disable Time (t_{HZ} , t_{LZ})		500	2500	ns	$R_L = 110\ \Omega$, $C_L = 50\text{ pF}$; see Figure 4 and Figure 28
Enable Time from Shutdown		4000	5500	ns	$R_L = 110\ \Omega$, $C_L = 50\text{ pF}$; see Figure 4 and Figure 28
RECEIVER					
Propagation Delay (t_{PLH} , t_{PHL})		120	200	ns	$C_L = +15\text{ pF}$, $V_{ID}^1 \geq \pm 1.5\text{ V}$; see Figure 3 and Figure 29
		140	220	ns	$C_L = +15\text{ pF}$, $V_{ID}^1 \geq \pm 600\text{ mV}$; see Figure 3 and Figure 29
Skew (t_{SKEW})		4	40	ns	$C_L = +15\text{ pF}$, $V_{ID}^1 \geq \pm 1.5\text{ V}$; see Figure 3 and Figure 29
Enable Time (t_{ZH} , t_{ZL})		12	55	ns	$R_L = 1\text{ k}\Omega$, $C_L = 15\text{ pF}$; see Figure 5 and Figure 30
Disable Time (t_{HZ} , t_{LZ})		12	55	ns	$R_L = 1\text{ k}\Omega$, $C_L = 15\text{ pF}$; see Figure 5 and Figure 30
Enable Time from Shutdown		3000	4500	ns	$R_L = 1\text{ k}\Omega$, $C_L = 15\text{ pF}$; see Figure 5 and Figure 30
Time to Shutdown	50	330	3000	ns	$R_L = 1\text{ k}\Omega$, $C_L = 15\text{ pF}$; see Figure 5 and Figure 30
Rx, Pulse Width Distortion			40	ns	$C_L = +15\text{ pF}$, $V_{ID}^1 \geq \pm 1.5\text{ V}$; see Figure 3 and Figure 29

¹ V_{ID} is the input differential voltage to the RS-485 receiver.

TIMING DIAGRAMS

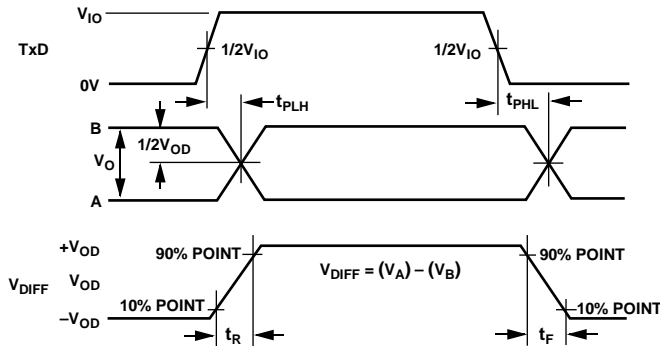

NOTES

- V_{OD} IS THE DIFFERENCE BETWEEN A AND B, WITH $+V_{OD}$ BEING THE MAXIMUM POINT OF V_{OD} , AND $-V_{OD}$ BEING THE MINIMUM POINT OF V_{OD} .

Figure 2. Driver Propagation Delay, Rise/Fall Timing Diagram

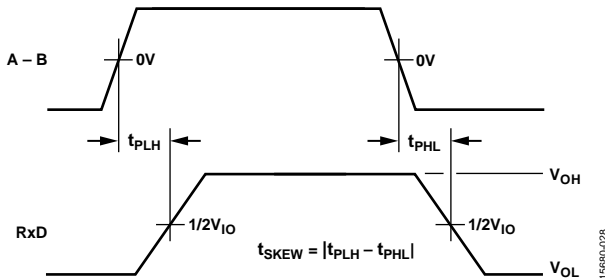

Figure 3. Receiver Propagation Delay Timing Diagram

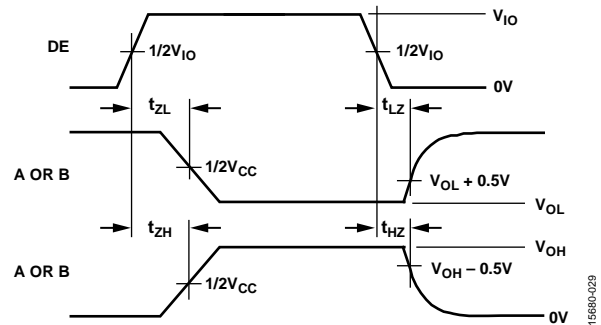

Figure 4. Driver Enable/Disable Timing Diagram

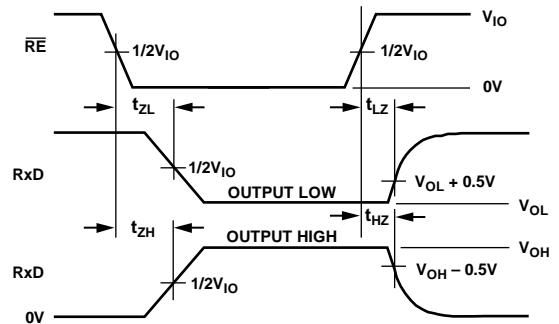

Figure 5. Receiver Enable/Disable Timing Diagram

ABSOLUTE MAXIMUM RATINGS

$T_A = 25^\circ\text{C}$, unless otherwise noted.

Table 3.

Parameter	Rating
V_{CC} to GND	-0.5 V to +7 V
V_{IO} to GND	-0.5 V to +7 V
Digital Input/Output Voltage (DE, \overline{RE} , TxD, RxD)	-0.3 V to $V_{IO} + 0.3$ V
Driver Output/Receiver Input Voltage	± 48 V
Military Operating Temperature Range	-55°C to $+125^\circ\text{C}$
Storage Temperature Range	-65°C to $+150^\circ\text{C}$
Maximum Junction Temperature	150°C
Continuous Total Power Dissipation	400 mW
Lead Temperature	
Soldering (10 sec)	300°C
Vapor Phase (60 sec)	215°C
Infrared (15 sec)	220°C
ESD (A and B pins only)	
IEC 61000-4-2 Contact Discharge	± 8 kV
IEC 61000-4-2 Air Discharge	± 15 kV
Electrical Fast Transients (EFT) (A and B Pins Only)	
IEC 61000-4-4 Level 4 EFT	± 2 kV
Surge (A and B pins only)	
IEC 61000-4-5 Level 4 Surge	± 4 kV
Human Body Model (HBM) ESD Protection	
All Pins	± 4 kV
A and B Pins Only	$> \pm 30$ kV
Field Induced Charged Device Model (FICDM) ESD	± 1.25 kV

Stresses at or above those listed under Absolute Maximum Ratings may cause permanent damage to the product. This is a stress rating only; functional operation of the product at these or any other conditions above those indicated in the operational section of this specification is not implied. Operation beyond the maximum operating conditions for extended periods may affect product reliability.

THERMAL RESISTANCE

Thermal performance is directly linked to printed circuit board (PCB) design and operating environment. Careful attention to PCB thermal design is required.

Table 4. Thermal Resistance

Package Type	θ_{JA}^1	θ_{JC}^1	Unit
R-16	50.9	18.9	$^\circ\text{C}/\text{W}$

¹ Thermal impedance simulated values are based on JEDEC 2S2P thermal test board with no vias. See JEDEC JESD51.

ESD CAUTION



ESD (electrostatic discharge) sensitive device. Charged devices and circuit boards can discharge without detection. Although this product features patented or proprietary protection circuitry, damage may occur on devices subjected to high energy ESD. Therefore, proper ESD precautions should be taken to avoid performance degradation or loss of functionality.

PIN CONFIGURATION AND FUNCTION DESCRIPTIONS

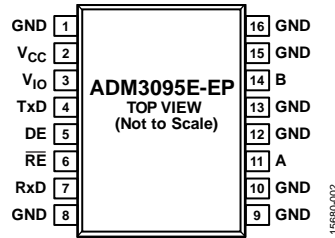

Figure 6. ADM3095E-EP Pin Configuration

Table 5. ADM3095E-EP Pin Descriptions

Pin No.	Mnemonic	Description
1, 8 to 10, 12, 13, 15, 16	GND	Ground.
2	V _{CC}	3.0 V to 5.5 V Power Supply. It is recommended that a 0.1 μ F decoupling capacitor is added between Pin V _{CC} and Pin GND.
3	V _{IO}	1.62 V to 5.5 V V _{IO} Logic Supply. It is recommended that a 0.1 μ F decoupling capacitor is added between Pin V _{IO} and Pin GND.
4	TxD	Transmit Data Input. Data transmitted by the driver is applied to this input.
5	DE	Driver Output Enable. A high level on this pin enables the A and B driver differential outputs. A low level places them into a high impedance state.
6	$\overline{\text{RE}}$	Receiver Enable Input. This is an active low input. Driving this input low enables the receiver and driving the input high disables the receiver.
7	RxD	Receiver Output Data. This output is high when $(A - B) > -30$ mV and low when $(A - B) < -200$ mV.
11	A	Noninverting Driver Output/Receiver Input. When the driver is disabled, or when V _{CC} is powered down, Pin A is put into a high impedance state to avoid overloading the bus.
14	B	Inverting Driver Output/Receiver Input. When the driver is disabled, or when V _{CC} is powered down, Pin B is put into a high impedance state to avoid overloading the bus.

TYPICAL PERFORMANCE CHARACTERISTICS

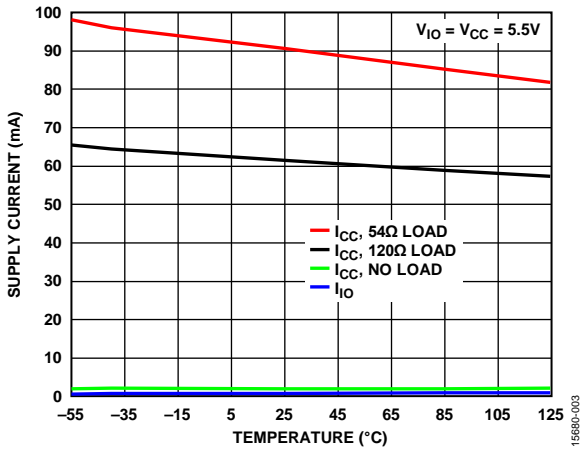

Figure 7. Supply Current vs. Temperature, Data Rate = 2.5 Mbps $V_{IO} = V_{CC} = 5.5V$

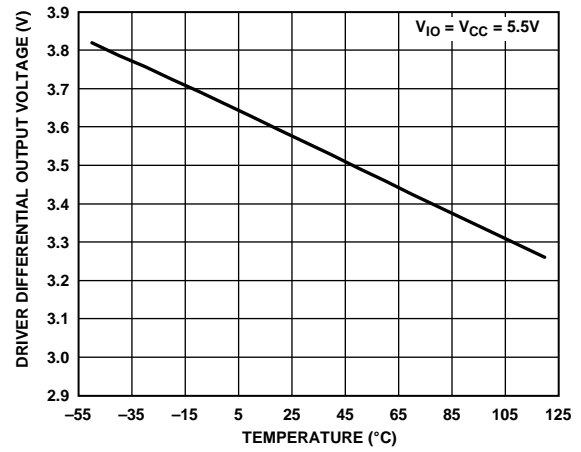

Figure 10. Driver Differential Output Voltage vs. Temperature

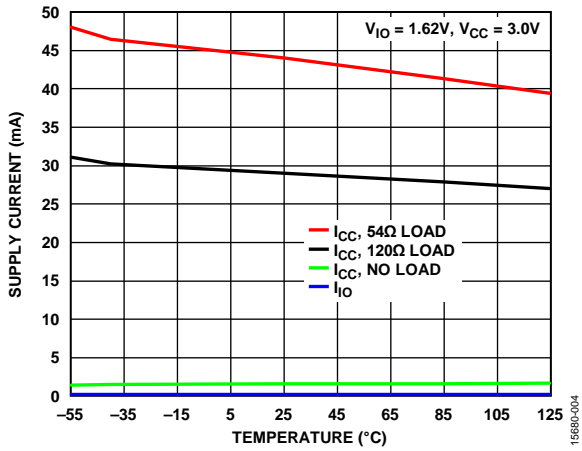

Figure 8. Supply Current vs. Temperature, Data Rate = 2.5 Mbps $V_{IO} = 1.62V, V_{CC} = 3.0V$

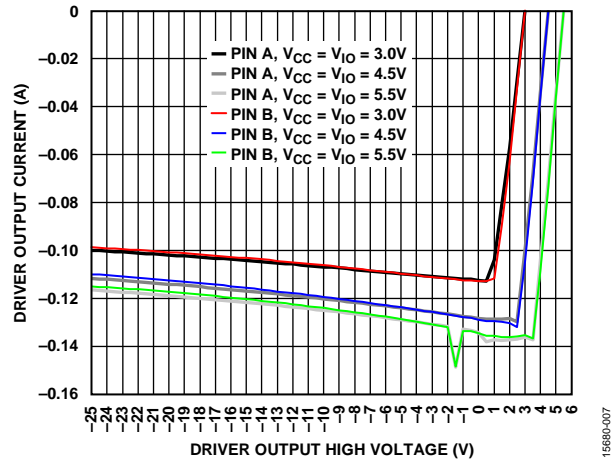

Figure 11. Driver Output Current vs. Driver Output High Voltage

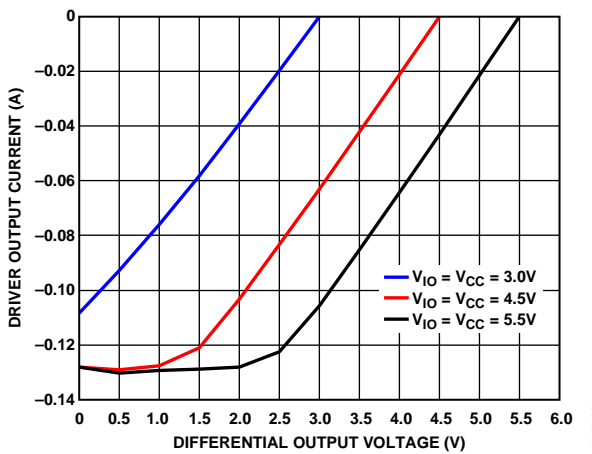

Figure 9. Driver Output Current vs. Differential Output Voltage

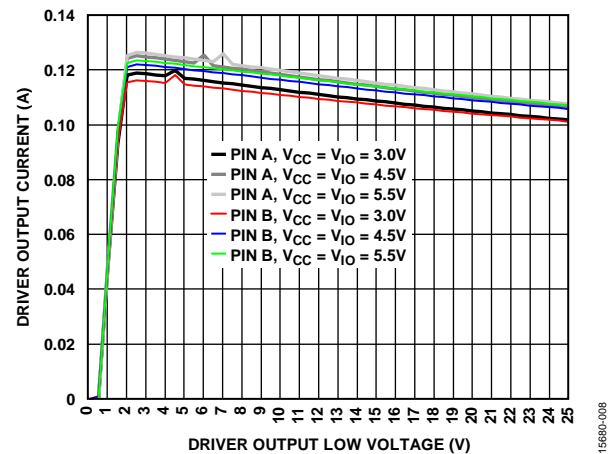

Figure 12. Driver Output Current vs. Driver Output Low Voltage

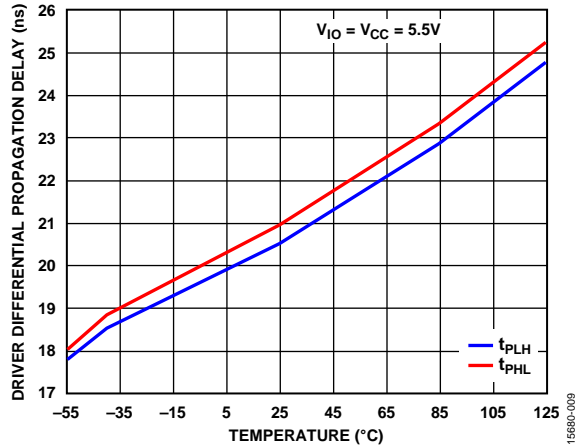

Figure 13. Driver Differential Propagation Delay vs. Temperature

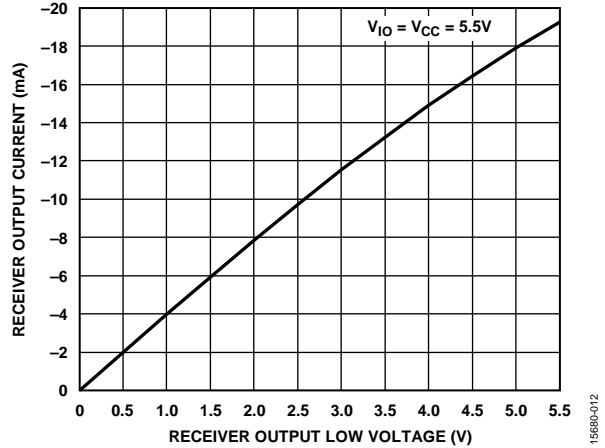

Figure 16. Receiver Output Current vs. Receiver Output Low Voltage

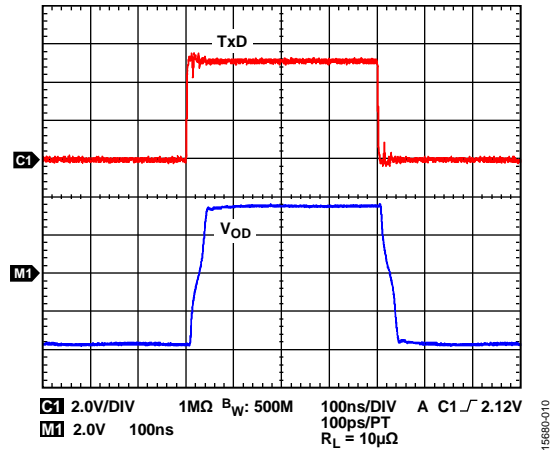

Figure 14. Driver Propagation Delay

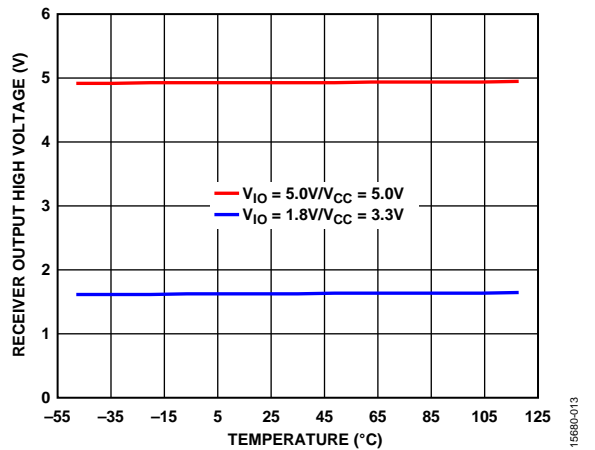

Figure 17. Receiver Output High Voltage vs. Temperature

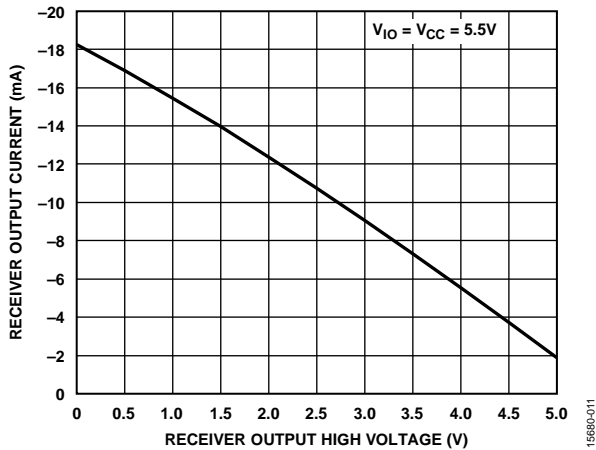

Figure 15. Receiver Output Current vs. Receiver Output High Voltage

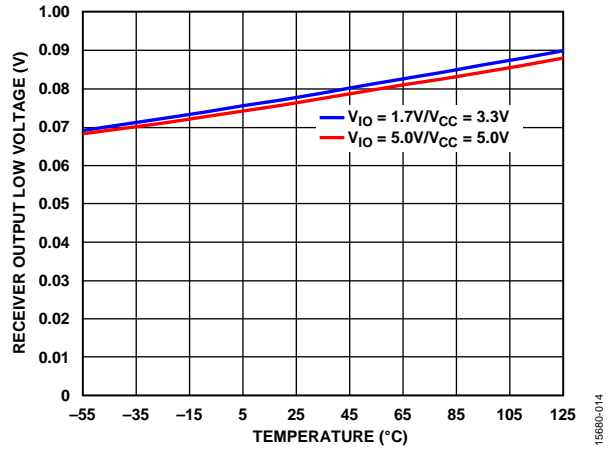

Figure 18. Receiver Output Low Voltage vs. Temperature

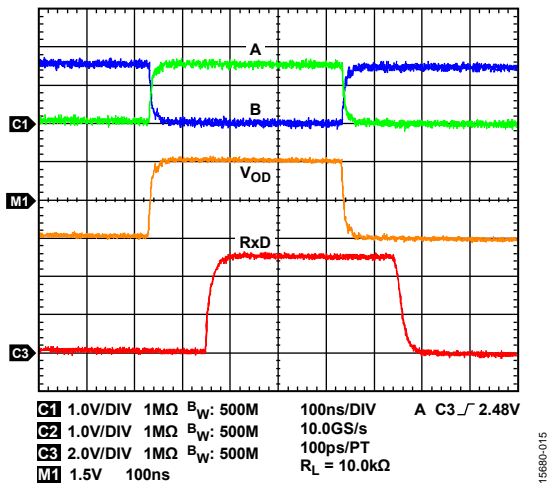

Figure 19. Receiver Propagation Delay

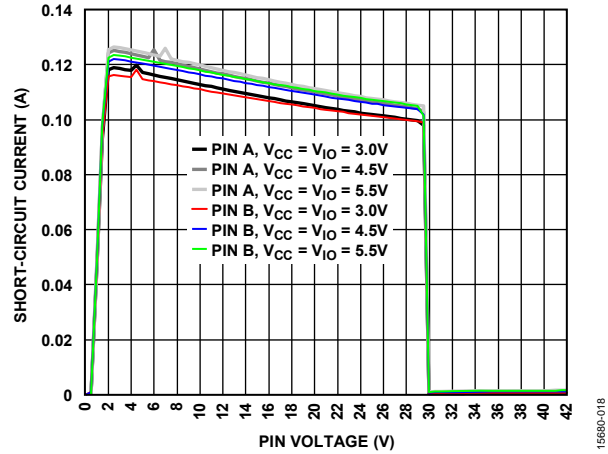

Figure 22. Short-Circuit Current vs. Pin Voltage

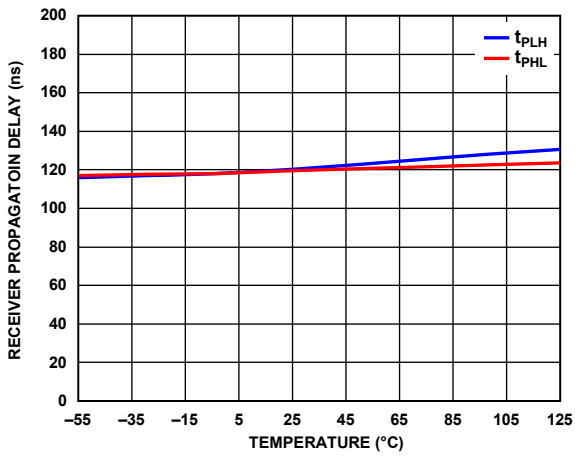

Figure 20. Receiver Propagation Delay vs. Temperature

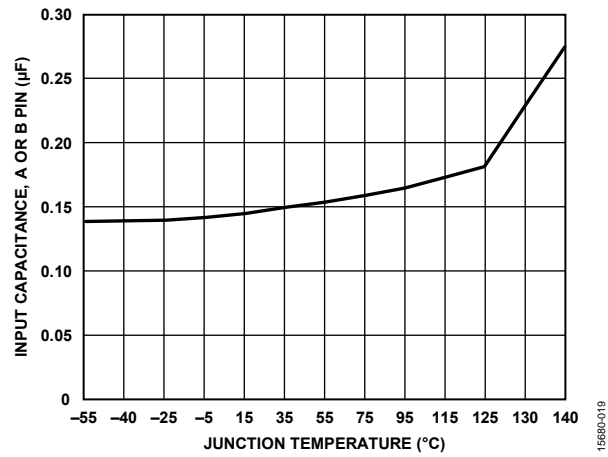

Figure 23. Input Capacitance, A or B Pin vs. Junction Temperature

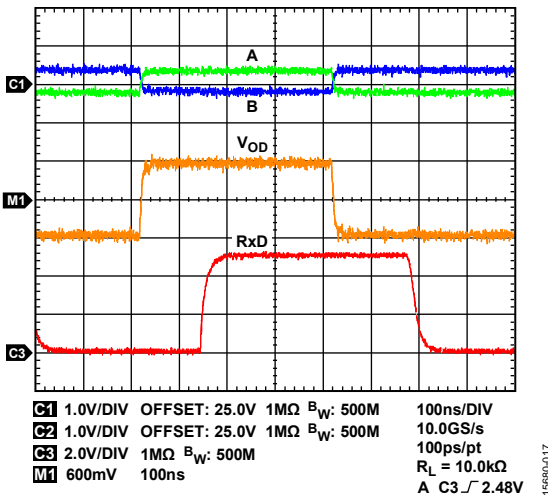

Figure 21. Receiver Performance with Input Common-Mode Voltage of 2.5 V

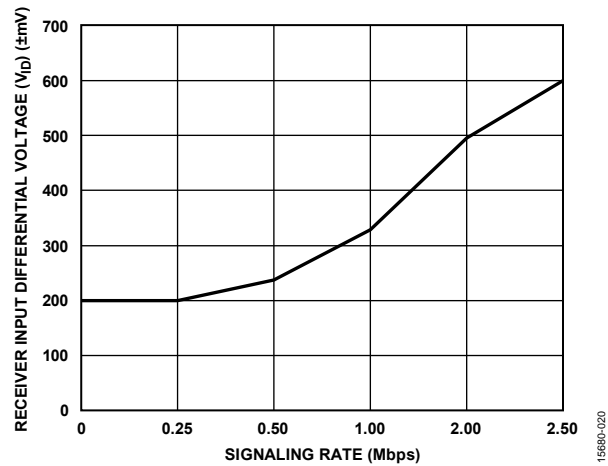

Figure 24. Receiver Input Differential Voltage (V_{ID}) vs. Signaling Rate

TEST CIRCUITS

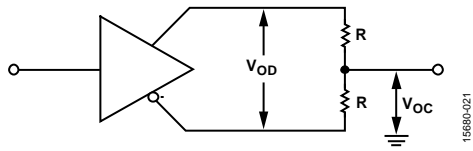

Figure 25. Driver Voltage Measurement

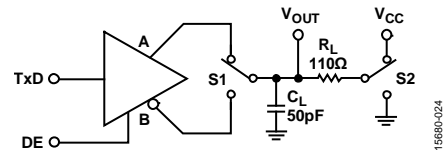

Figure 28. Driver Enable/Disable

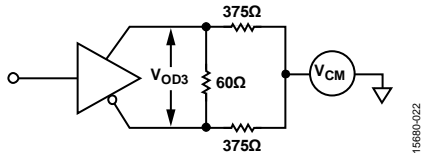

Figure 26. Driver Voltage Measurement over Common-Mode Voltage Range

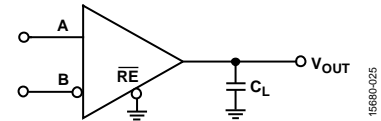

Figure 29. Receiver Propagation Delay

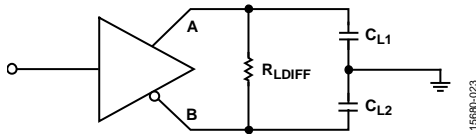

Figure 27. Driver Propagation Delay

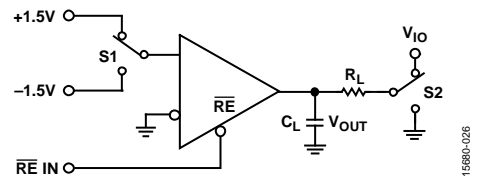

Figure 30. Receiver Enable/Disable

THEORY OF OPERATION

RS-485 WITH ADDED DO-160G EMC ROBUSTNESS

The ADM3095E-EP is a 3.0 V to 5.5 V RS-485 transceiver with added robustness that reduces system failures when operating in harsh application environments, such as MILA avionics for sensors, actuators, and engine control.

Lightning strikes to jet airliners are common—about once every 1000 flight hours. The DO-160G standard, *Environmental Conditions and Test Procedures for Airborne Equipment*, is a standard for the environmental testing of avionics hardware. Many airplane manufacturers specify DO-160G, Section 22, lightning induced transient susceptibility, as a requirement for critical systems, like guidance, radars, communications, engine controls, heat controls, and air controls. Aircraft radome, wing tips, fin tips, nacelles, and landing gear are areas most likely to be hit by lightning strikes.

The ADM3095E-EP integrates fully certified DO-160G EMC protection on RS-485 bus pins, with Section 22 lightning protection. The ADM3095E-EP also provides Section 25 ±15 kV ESD air discharge protection. For Section 22 lightning, the ADM3095E-EP provides protection against Waveform 3, Waveform 4/Waveform 1, and Waveform 5A to Level 4 using 33 Ω or 47 Ω current limiting resistors to GND.

CERTIFIED DO-160G EMC PROTECTION

Table 6 details the open circuit voltage (V_{OC}) and short-circuit current (I_{SC}) as specified in the DO-160G Section 22 lightning transient susceptibility standard for Waveform 3, Waveform 4/ Waveform 1, and Waveform 5A for pin injection testing. The peak currents for the DO-160G Level 4 tests are much greater than the standard industrial surge IEC 61000-4-5 peak currents.

The waveform shape with rise and decay times for the DO-160G standard are significantly longer than those specified by the IEC 61000-4-5 standard, as shown in Figure 31. Due to the high amounts of energy associated with the DO-160G Section 22 lightning standard, the ADM3095E-EP is tested using external 33 Ω or 47 Ω A pin and B pin bus current limiting resistors for testing to GND. These resistors are required in addition to the ADM3095E-EP integrated EMC protection circuitry.

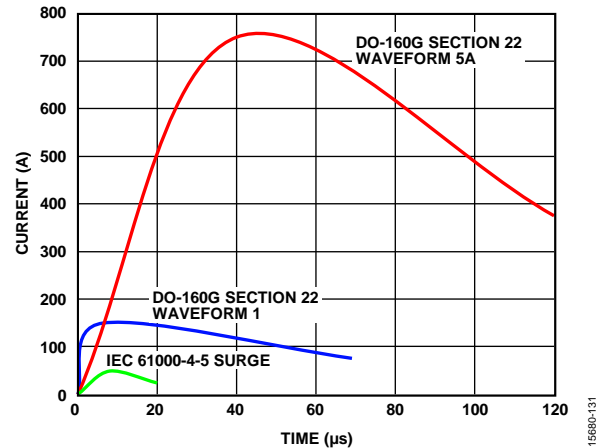

Figure 31. DO-160G Section 22 Waveform 1 and Waveform 5A, and IEC 61000-4-5 Surge Waveform

DO-160G ADM3095E-EP TEST DETAILS

Figure 32 and Figure 33 show the Waveform 3 test setup coupling and decoupling network (CDN), the Waveform 5A, and Waveform 4/Waveform 1 CDN. For testing to the RS-485 bus side, GND, an additional 33 Ω or 47 Ω current limiting resistance is added on the A and B bus pins. DO-160G Section 22 testing is performed on one pin at a time. The test is not performed in common mode. Table 7 and Table 8 show a summary of the ADM3095E-EP certified test results.

Table 6. DO-160G Section 22 Pin Injection Level 4 Compared to IEC 61000-4-5 Lightning Level 4

Level	DO-160G Waveform 3	DO-160G Waveform 4/Waveform 1	DO-160G Waveform 5A	IEC 61000-4-5
4	1500 V, 60 A	750 V, 150 A	750 V, 750 A	4000 V, 49 A
3	600 V, 24 A	300 V, 60 A	300 V, 300 A	2000 V, 24.5 A

Table 7. DO-160G Section 22 Pin Injection Level 4 Certified Test Results

Testing to	Current Limiting Resistor	DO-160 Waveform 3; 1500 V, 60 A	DO-160 Waveform 4/ Waveform 1; 750 V, 150 A	DO-160 Waveform 5A; 750 V, 750 A
GND	47 Ω or 33 Ω	Pass with 47 Ω	Pass with 33 Ω	Pass with 33 Ω

Table 8. DO-160G Section 22 Pin Injection Level 3 Certified Test Results

Testing to	Current Limiting Resistor	DO-160 Waveform 3; 600 V, 24 A	DO-160 Waveform 4/ Waveform 1; 300 V, 60 A	DO-160 Waveform 5A; 300 V, 300 A
GND	33 Ω	Pass	Pass	Pass

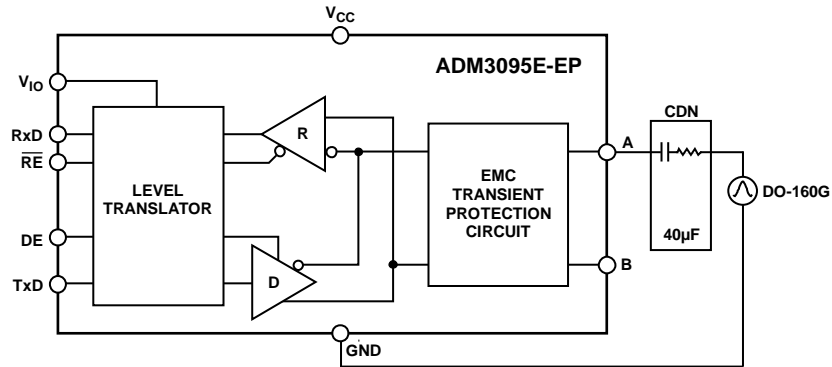

Figure 32. DO-160G Section 22 Waveform, 3 Test Setup and CDN Network

15680-132

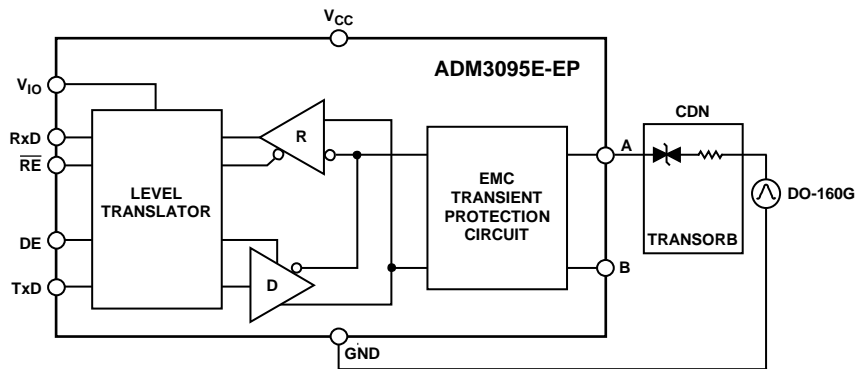
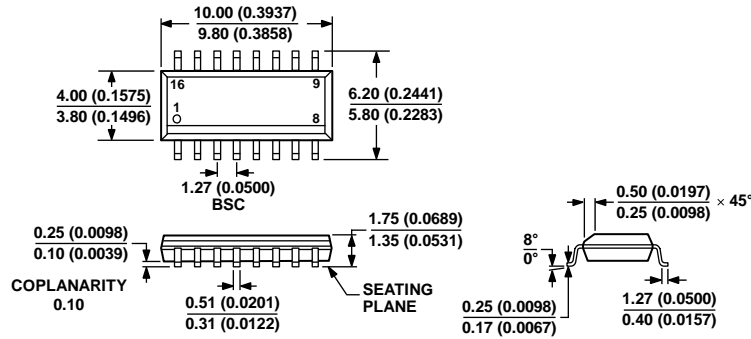

Figure 33. DO-160G Section 22 Waveform 5A and Waveform 4/Waveform 1 Test Setup and CDN Network

15680-133

OUTLINE DIMENSIONS



COMPLIANT TO JEDEC STANDARDS MS-012-AC
 CONTROLLING DIMENSIONS ARE IN MILLIMETERS; INCH DIMENSIONS
 (IN PARENTHESES) ARE ROUNDED-OFF MILLIMETER EQUIVALENTS FOR
 REFERENCE ONLY AND ARE NOT APPROPRIATE FOR USE IN DESIGN.

060606-A

Figure 34. 16-Lead Standard Small Outline Package [SOIC_N]
 Narrow Body
 (R-16)

Dimensions shown in millimeters and (inches)

ORDERING GUIDE

Model ¹	Temperature Range	Package Description	Package Option
ADM3095ETRZ-EP	-55°C to +125°C	16-Lead Standard Small Outline Package [SOIC_N]	R-16
ADM3095ETRZ-EP-R7	-55°C to +125°C	16-Lead Standard Small Outline Package [SOIC_N]	R-16
EVAL-ADM3095EEPZ		Evaluation Board	

¹ Z = RoHS Compliant Part.