

THIS DRAWING IS UNPUBLISHED
 RELEASED FOR PUBLICATION
 - .2017.
 © COPYRIGHT 2017 By -TE Connectivity Germany GmbH
 ALL RIGHTS RESERVED.

REVISIONS				
P	LTR	DESCRIPTION	DATE	APVD
	A1	NEW RELEASE	09MAR2017	GCM/MSZ

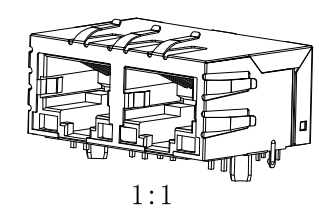
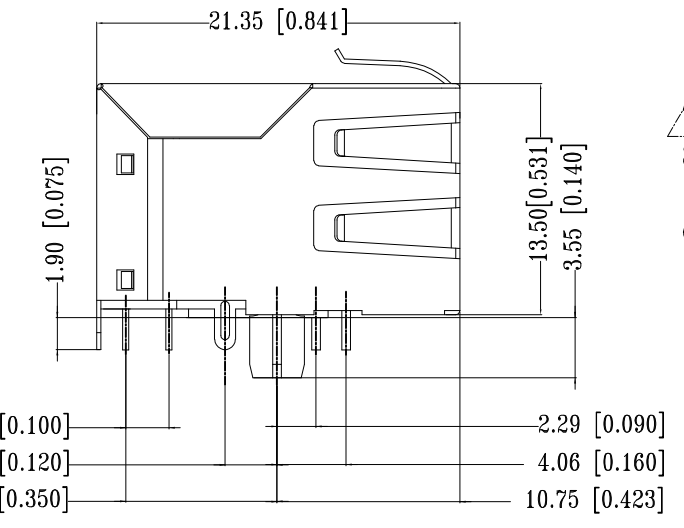
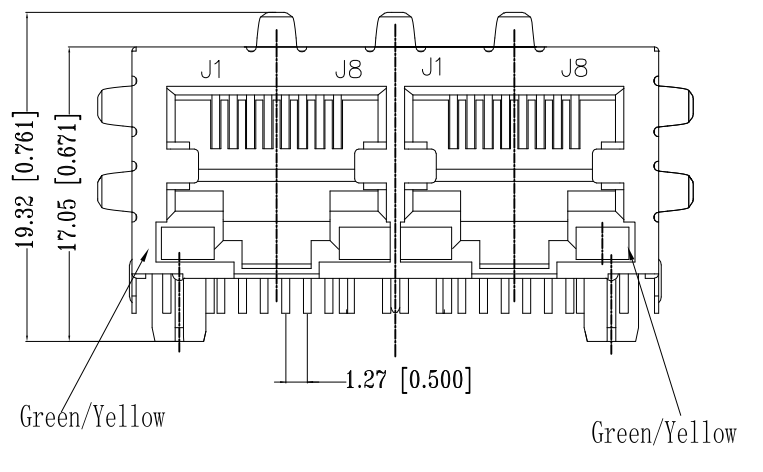
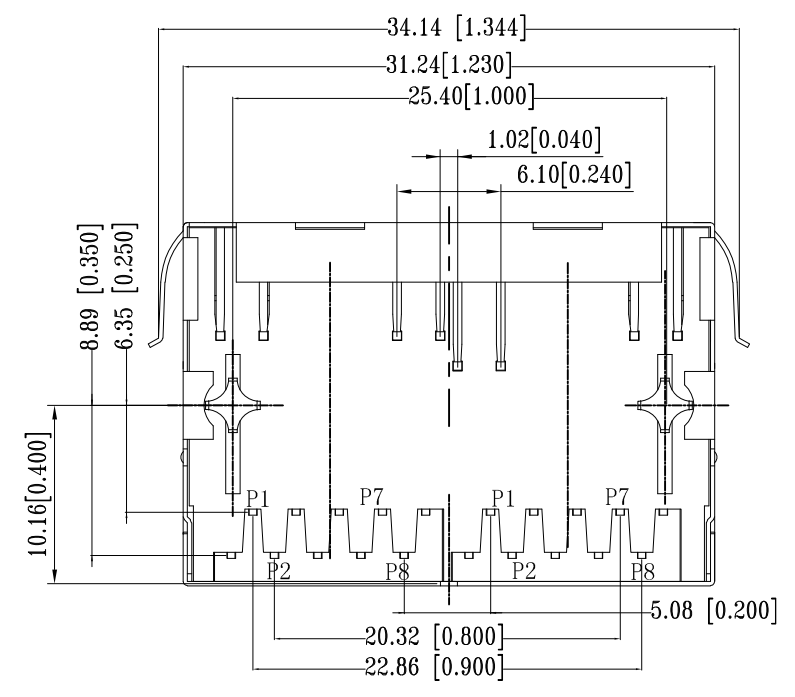

- △ CONNECTOR MATERIAL:
 HOUSING: LCP BLACK UL94 V-0
 INSERT: LCP BLACK UL94 V-0
 SHIELD: BRASS
 SHIELD PLATING: NICKEL
 CONTACT: COPPER ALLOY
 CONTACT PLATING: SELECTIVE GOLD, MIN. 0.76µm (30µinch) IN CONTACT AREA
 OVER MIN. 1.27µm (50µinch) NICKEL
 SOLDER PIN PLATING: 3.05µm (120µinch) TIN OVER 1.02µm (40µinch) NICKEL
 OVER ALL
 SHIELDING PIN PLATING: NICKEL
- 2 PIN NOT ELECTRICALLY CONNECTED MAYBE OMITTED SEE ELECTRICAL CIRCUIT DIAGRAM FOR OMITTED PINS
- 3 RJ45 CAVITIES CONFORM TO FCC RULES AND REGULATION PART 68
- 4 THE PART IS RECOMMENDED FOR REFLOW SOLDERING PROCESS PEAK SOLDERING: TEMPERATURE MAX. +260° C, MAX. 10s
- 5 OPERATING TEMPERATURE: T= -40° C TO +85° C
- 6 STORAGE TEMPERATURE: T= -40° C TO +85° C
- △ UNLESS OTHERWISE SPECIFIED, SEE TABLE FOR ALL DIMENSIONS TOLERANCES
- 8 JACK CONFIGURATION: 1 x 2
 TAB DIRECTION: DOWN
- 9 PACKAGING: REEL (T+R) ACCORDING TO PACKAGING SPECIFICATION 107-18116

TABLE OF TOLERANCE (mm)	
RANGE	TOLERANCE
0-10	±0.15
>10-40	±0.25
>40-70	±0.30
>70	±0.40

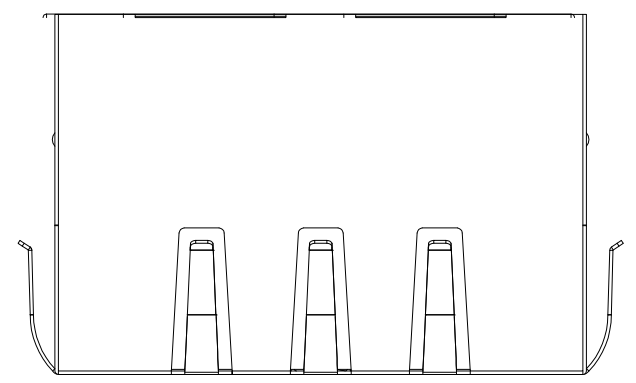



THIS DRAWING IS A CONTROLLED DOCUMENT.		DWN 27AUG2016 GANESH C M	TE Connectivity	
DIMENSIONS: mm [INCHES]		CHK 27AUG2016 FRANZ MUELLER		
TOLERANCES UNLESS OTHERWISE SPECIFIED: 0 PLC ± - 1 PLC ± - 2 PLC ± - 3 PLC ± - 4 PLC ± - ANGLES ± - MATERIAL △ 1		APVD 27AUG2016 MARTIN SZELAG	NAME RJ45 JACK INT.MAG. 10/100 LED 1x2	
		PRODUCT SPEC 108-94552	RESTRICTED TO	
FINISH △ 1		APPLICATION SPEC 114-94447	SIZE A3	CAGE CODE 00779
		WEIGHT -	DRAWING NO C-2301996-6	
		CUSTOMER DRAWING	SCALE 3:1	SHEET 1 OF 3
			REV A1	

REVISIONS

P	LTR	DESCRIPTION	DATE	DWN	APVD
-	-	SEE SHEET 1	-	-	-

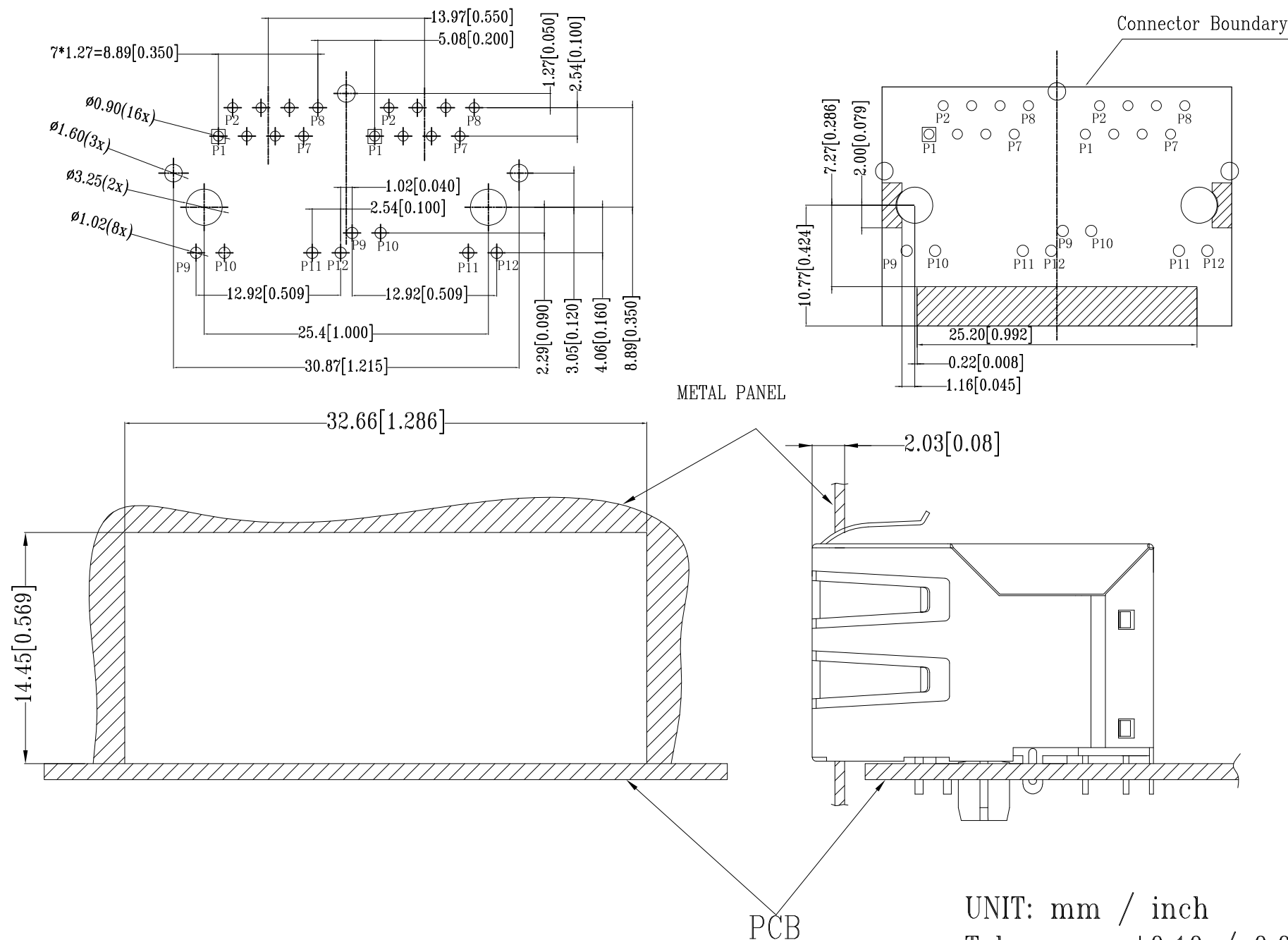
SUGGESTED PCB LAYOUT



THIS DRAWING IS A CONTROLLED DOCUMENT.		DWN	27AUG2016		 TE Connectivity			
		CHK	27AUG2016					
		APVD	27AUG2016					
		NAME	FRANZ MUELLER					
		PRODUCT SPEC	MARTIN SZELAG		RJ45 JACK INT.MAG. 10/100 LED 1x2			
		APPLICATION SPEC	108-94552					
		WEIGHT	114-94447		SIZE	CAGE CODE	DRAWING NO	RESTRICTED TO
			0		A3	00779	C-2301996-6	-
		CUSTOMER DRAWING		SCALE	SHEET	REV		
				3:1	2 OF 3	A1		

REVISIONS					
P	LTR	DESCRIPTION	DATE	DWN	APVD
-	-	SEE SHEET 1	-	-	-

ELECTRICAL CIRCUIT DIAGRAM

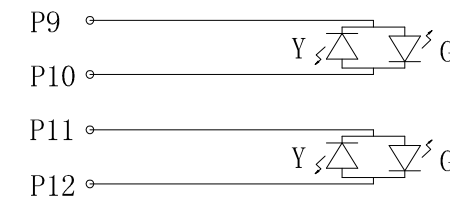
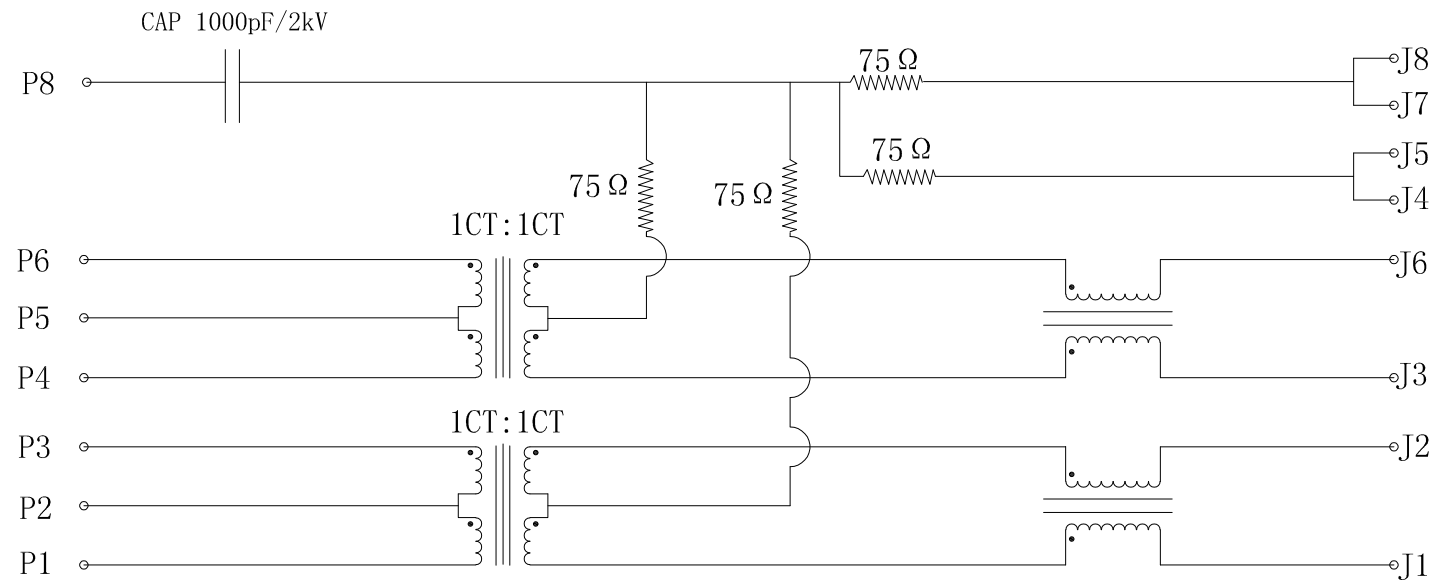

Pin	Yellow	Green	Pin	Yellow	Green
P9	-	+	P11	-	+
P10	+	-	P12	+	-

- 1.0 Turn Ratio @100kHz: (P1~P3):(J1~J2) = 1:1±2%
 (P4~P6):(J3~J6) = 1:1±2%
- 2.0 Primary Inductance: 350µH MIN. @100kHz, 0.1V 8mA DC BIAS
- 3.0 DC Resistance: 1.2 OHMS MAX.
- 4.0 Insertion Loss: 1-100MHz -1.2dB MAX.
- 5.0 Return Loss: 1-30MHz -16dB MIN.
 30-60MHz -12dB MIN.
 60-80MHz -10dB MIN.
- 6.0 CROSS TALK: 1-100MHz -30dB MIN.
- 7.0 COMMON TO COMMON MODE ATTENUATION: 1-100MHz -30dB MIN.
- 8.0 Isolation: PHY Side to Line Side: 2250VDC

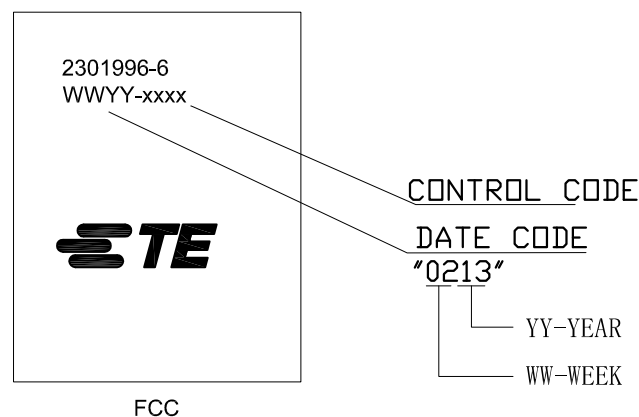

THIS DRAWING IS A CONTROLLED DOCUMENT.		DWN GANESH C M 27AUG2016	TE Connectivity RJ45 JACK INT.MAG. 10/100 LED 1x2		
DIMENSIONS: mm [INCHES]		CHK FRANZ MUELLER 27AUG2016			
TOLERANCES UNLESS OTHERWISE SPECIFIED:		APVD MARTIN SZELAG 27AUG2016	NAME		
0 PLC ± - 1 PLC ± - 2 PLC ± - 3 PLC ± - 4 PLC ± - ANGLES ± -		PRODUCT SPEC 108-94552	RESTRICTED TO		
MATERIAL 1		FINISH 1	APPLICATION SPEC 114-94447	SIZE A3	CAGE CODE 00779
			WEIGHT	DRAWING NO C-2301996-6	
CUSTOMER DRAWING			SCALE 3:1	SHEET 3 OF 3	REV A1