

BCX71JLT1G

General Purpose Transistor PNP Silicon

Features

- Moisture Sensitivity Level: 1
- These Devices are Pb-Free, Halogen Free/BFR Free and are RoHS Compliant

MAXIMUM RATINGS

Rating	Symbol	Value	Unit
Collector – Emitter Voltage	V_{CEO}	-45	Vdc
Collector – Base Voltage	V_{CBO}	-45	Vdc
Emitter – Base Voltage	V_{EBO}	-5.0	Vdc
Collector Current – Continuous	I_C	-100	mAdc

THERMAL CHARACTERISTICS

Characteristic	Symbol	Max	Unit
Total Device Dissipation (Note 1) $T_A = 25^\circ\text{C}$ Derate above 25°C	P_D	350 2.8	mW mW/ $^\circ\text{C}$
Storage Temperature	T_{stg}	150	$^\circ\text{C}$
Thermal Resistance, Junction-to-Ambient (Note 1)	$R_{\theta JA}$	357	$^\circ\text{C}/\text{W}$

Stresses exceeding Maximum Ratings may damage the device. Maximum Ratings are stress ratings only. Functional operation above the Recommended Operating Conditions is not implied. Extended exposure to stresses above the Recommended Operating Conditions may affect device reliability.

- Package mounted on 99.5% alumina 10 X 8 X 0.6 mm.



ON Semiconductor®

<http://onsemi.com>

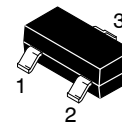
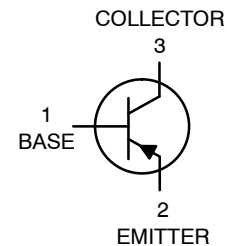

SOT-23
CASE 318
STYLE 6

MARKING DIAGRAM

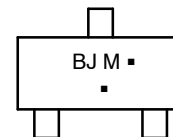

BJ = Device Code
M = Date Code*
▪ = Pb-Free Package

(Note: Microdot may be in either location)

*Date Code orientation and/or overbar may vary depending upon manufacturing location.

ORDERING INFORMATION

Device	Package	Shipping†
BCX71JLT1G	SOT-23 (Pb-free)	3000/Tape & Reel

†For information on tape and reel specifications, including part orientation and tape sizes, please refer to our Tape and Reel Packaging Specifications Brochure, BRD8011/D.

BCX71JLT1G

ELECTRICAL CHARACTERISTICS ($T_A = 25^\circ\text{C}$ unless otherwise noted)

Characteristic	Symbol	Min	Max	Unit
OFF CHARACTERISTICS				
Collector–Emitter Breakdown Voltage ($I_C = 2.0\text{ mAdc}$, $I_B = 0$)	$V_{(BR)CEO}$	-45	-	Vdc
Collector–Base Breakdown Voltage ($I_E = 1.0\text{ }\mu\text{Adc}$, $I_C = 0$)	$V_{(BR)EBO}$	-5.0	-	Vdc
Collector Cutoff Current ($V_{CE} = 32\text{ Vdc}$) ($V_{CE} = 32\text{ Vdc}$, $T_A = 150^\circ\text{C}$)	I_{CES}	-	-20	nAdc μAdc

ON CHARACTERISTICS

DC Current Gain ($I_C = 10\text{ }\mu\text{Adc}$, $V_{CE} = 5.0\text{ Vdc}$) ($I_C = 2.0\text{ mAdc}$, $V_{CE} = 5.0\text{ Vdc}$) ($I_C = 50\text{ mAdc}$, $V_{CE} = 1.0\text{ Vdc}$) ($I_C = 2.0\text{ mAdc}$, $V_{CE} = 5.0\text{ Vdc}$, $f = 1.0\text{ kHz}$)	h_{FE}	40 250 100 250	- 460 - 500	-
Collector–Emitter Saturation Voltage ($I_C = 10\text{ mAdc}$, $I_B = 0.25\text{ mAdc}$) ($I_C = 50\text{ mAdc}$, $I_B = 1.25\text{ mAdc}$)	$V_{CE(sat)}$	- -	-0.25 -0.55	Vdc
Base–Emitter Saturation Voltage ($I_C = 1.0\text{ mAdc}$, $V_{CE} = 5.0\text{ Vdc}$) ($I_C = 10\text{ mAdc}$, $V_{CE} = 5.0\text{ Vdc}$)	$V_{BE(sat)}$	-0.6 -0.68	-0.85 -1.05	Vdc
Base–Emitter On Voltage ($I_C = 2.0\text{ mAdc}$, $V_{CE} = 5.0\text{ Vdc}$)	$V_{BE(on)}$	-0.6	-0.75	Vdc
Output Capacitance ($V_{CE} = 10\text{ Vdc}$, $I_C = 0$, $f = 1.0\text{ MHz}$)	C_{obo}	-	6.0	pF
Noise Figure ($I_C = 0.2\text{ mAdc}$, $V_{CE} = 5.0\text{ Vdc}$, $R_S = 2.0\text{ k}\Omega$, $f = 1.0\text{ kHz}$, $BW = 200\text{ Hz}$)	NF	-	6.0	dB

SWITCHING CHARACTERISTICS

Turn–On Time ($I_C = 10\text{ mAdc}$, $I_{B1} = 1.0\text{ mAdc}$)	t_{on}	-	150	ns
Turn–Off Time ($I_{B2} = 1.0\text{ mAdc}$, $V_{BB} = 3.6\text{ Vdc}$, $R1 = R2 = 5.0\text{ k}\Omega$, $R_L = 990\text{ }\Omega$)	t_{off}	-	800	ns

TYPICAL NOISE CHARACTERISTICS

($V_{CE} = -5.0\text{ Vdc}$, $T_A = 25^\circ\text{C}$)

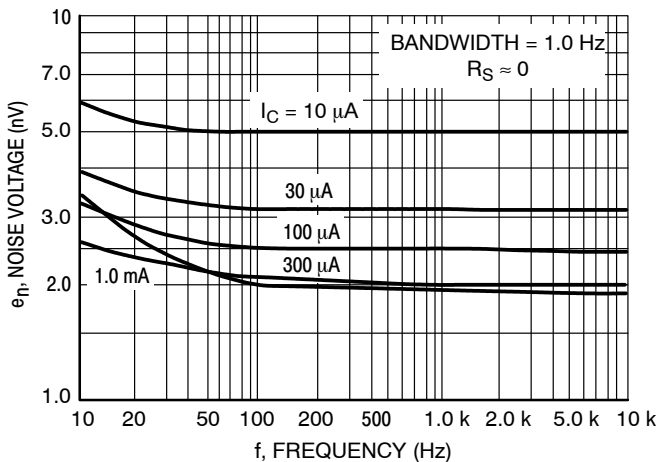

Figure 1. Noise Voltage

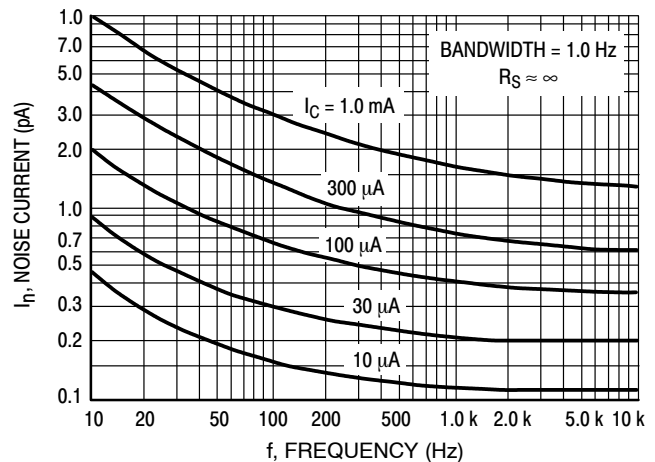

Figure 2. Noise Current

BCX71JLT1G

NOISE FIGURE CONTOURS

($V_{CE} = -5.0 \text{ Vdc}$, $T_A = 25^\circ\text{C}$)

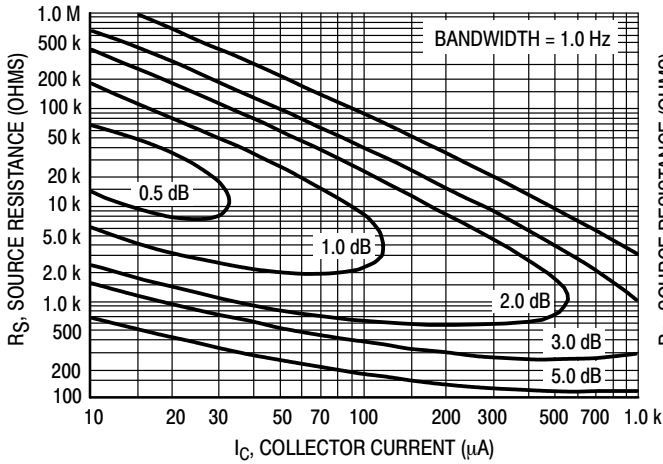

Figure 3. Narrow Band, 100 Hz

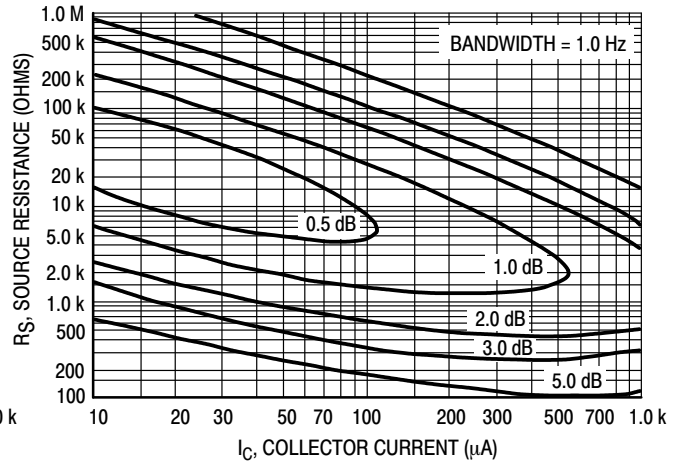

Figure 4. Narrow Band, 1.0 kHz

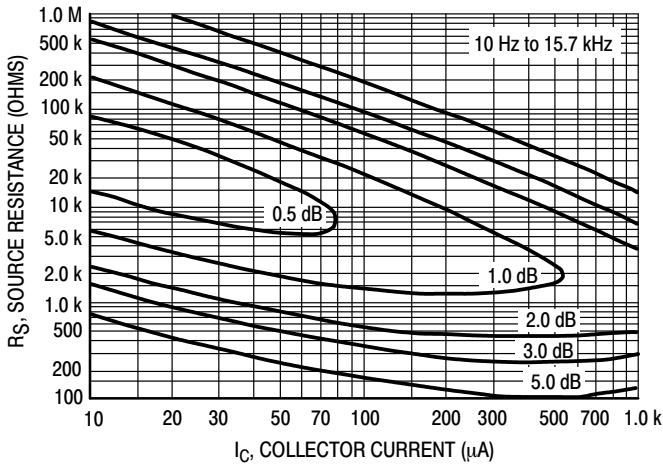

Figure 5. Wideband

Noise Figure is Defined as:

$$NF = 20 \log_{10} \left[\frac{e_n^2 + 4KTR_S + I_n^2 R_S^2}{4KTR_S} \right]^{1/2}$$

- e_n = Noise Voltage of the Transistor referred to the input. (Figure 3)
- I_n = Noise Current of the Transistor referred to the input. (Figure 4)
- K = Boltzman's Constant ($1.38 \times 10^{-23} \text{ J/}^\circ\text{K}$)
- T = Temperature of the Source Resistance ($^\circ\text{K}$)
- R_S = Source Resistance (Ohms)

TYPICAL STATIC CHARACTERISTICS

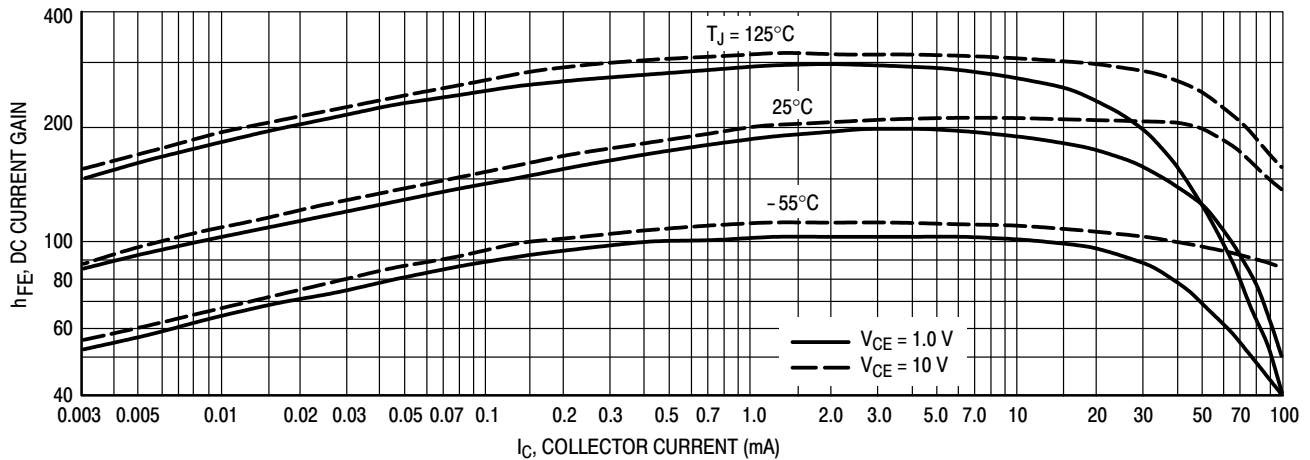

Figure 6. DC Current Gain

BCX71JLT1G

TYPICAL STATIC CHARACTERISTICS

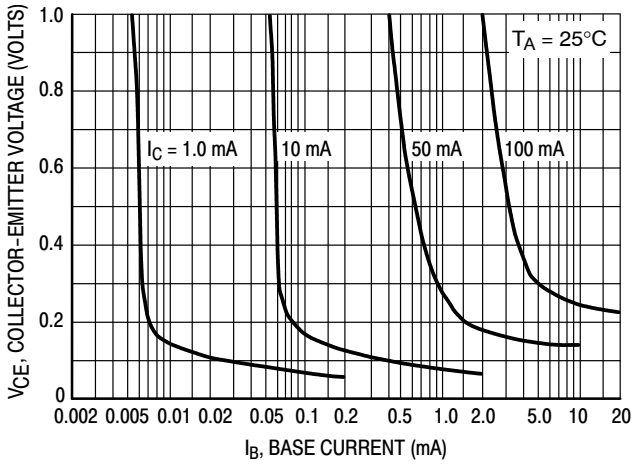

Figure 7. Collector Saturation Region

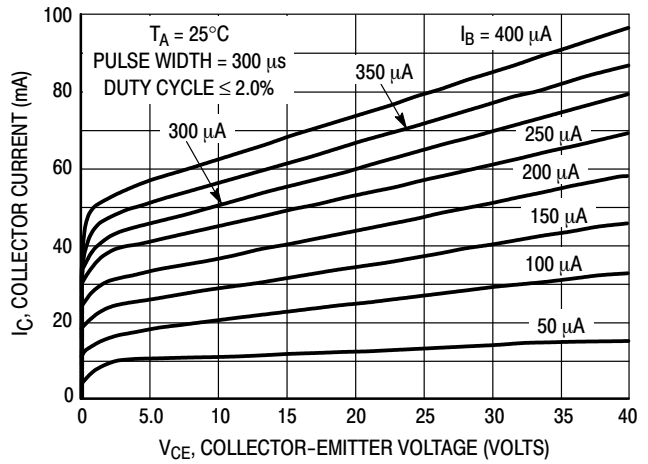

Figure 8. Collector Characteristics

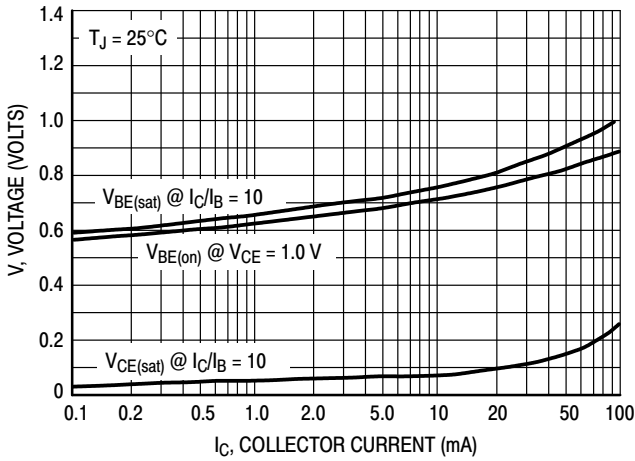

Figure 9. "On" Voltages

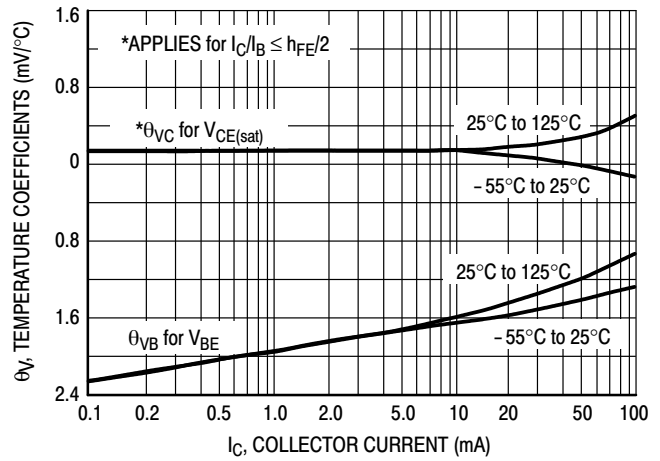

Figure 10. Temperature Coefficients

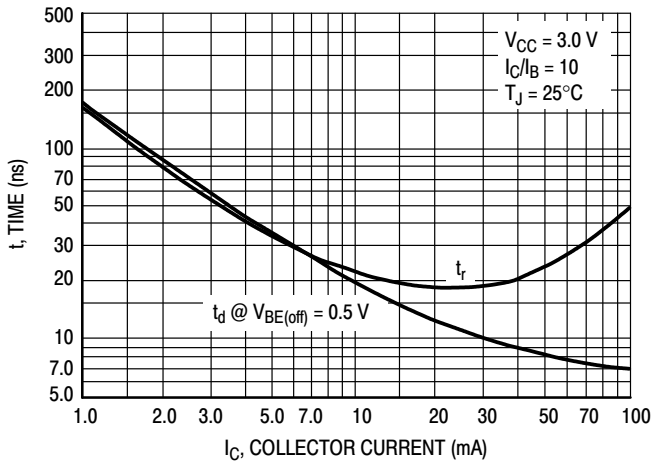

Figure 11. Turn-On Time

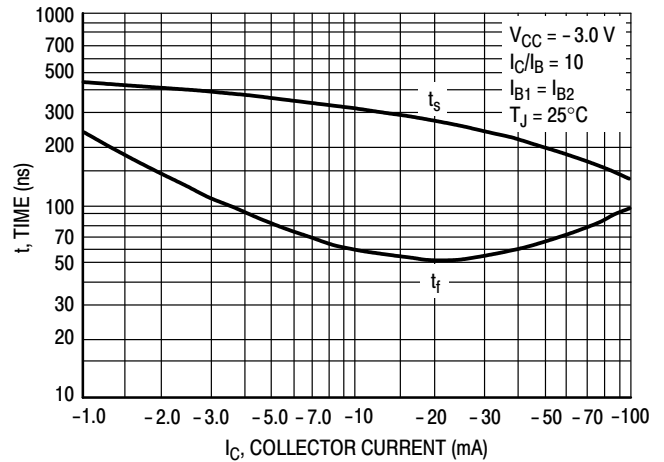

Figure 12. Turn-Off Time

BCX71JLT1G

TYPICAL DYNAMIC CHARACTERISTICS

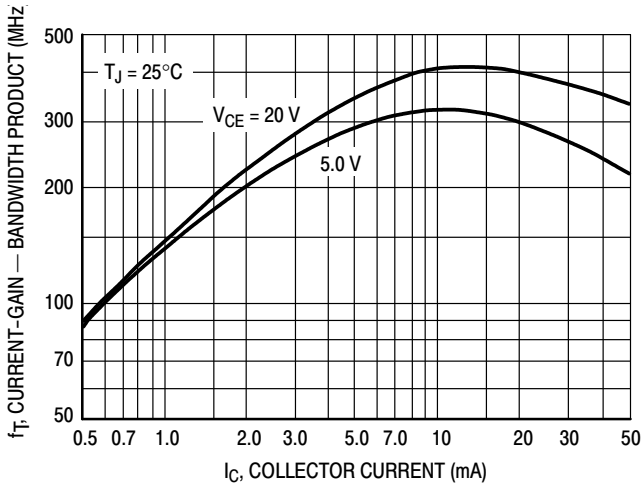

Figure 13. Current-Gain — Bandwidth Product

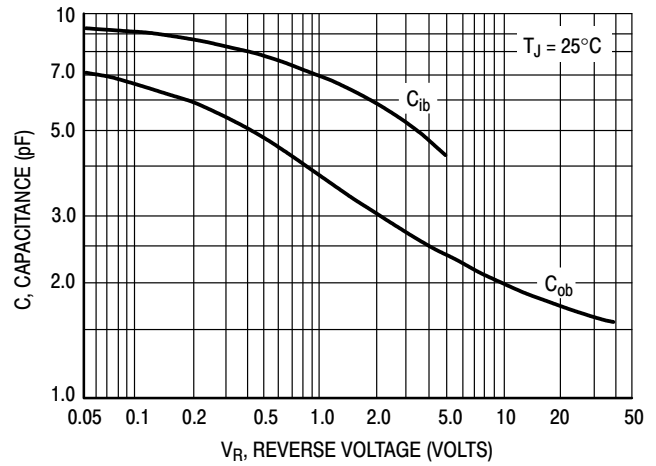

Figure 14. Capacitance

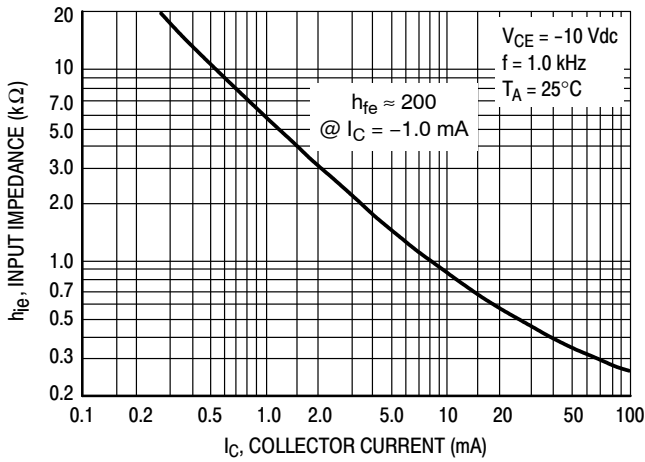

Figure 15. Input Impedance

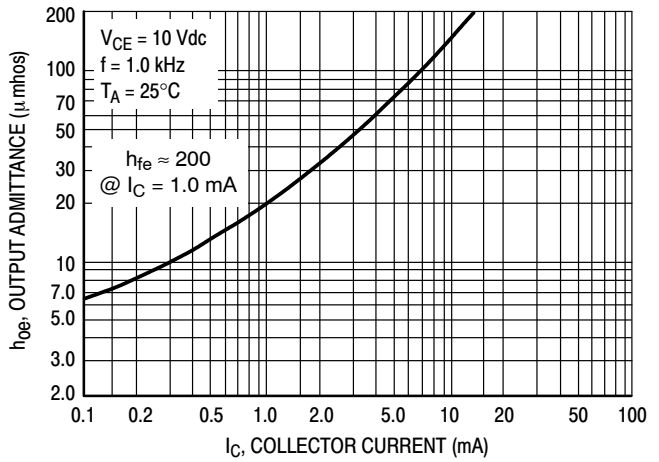

Figure 16. Output Admittance

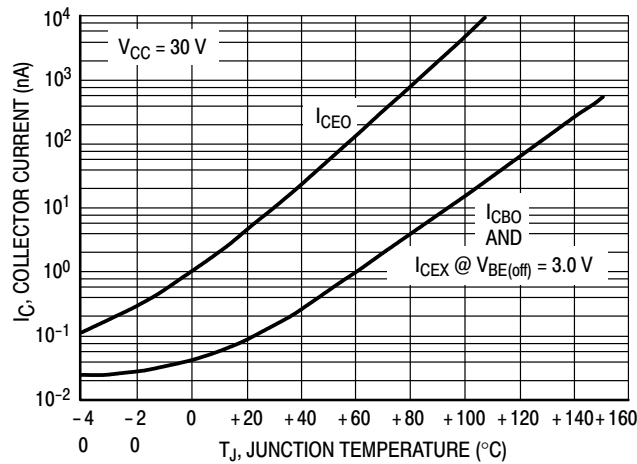
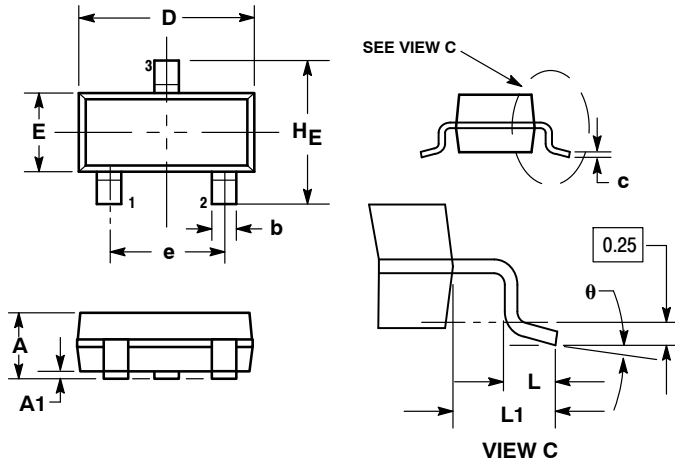

Figure 17. Typical Collector Leakage Current

BCX71JLT1G

PACKAGE DIMENSIONS

SOT-23 (TO-236)
CASE 318-08
ISSUE AN



- NOTES:
1. DIMENSIONING AND TOLERANCING PER ANSI Y14.5M, 1982.
 2. CONTROLLING DIMENSION: INCH.
 3. MAXIMUM LEAD THICKNESS INCLUDES LEAD FINISH THICKNESS. MINIMUM LEAD THICKNESS IS THE MINIMUM THICKNESS OF BASE MATERIAL.
 4. 318-01 THRU -07 AND -09 OBSOLETE, NEW STANDARD 318-08.

DIM	MILLIMETERS			INCHES		
	MIN	NOM	MAX	MIN	NOM	MAX
A	0.89	1.00	1.11	0.035	0.040	0.044
A1	0.01	0.06	0.10	0.001	0.002	0.004
b	0.37	0.44	0.50	0.015	0.018	0.020
c	0.09	0.13	0.18	0.003	0.005	0.007
D	2.80	2.90	3.04	0.110	0.114	0.120
E	1.20	1.30	1.40	0.047	0.051	0.055
e	1.78	1.90	2.04	0.070	0.075	0.081
L	0.10	0.20	0.30	0.004	0.008	0.012
L1	0.35	0.54	0.69	0.014	0.021	0.029
HE	2.10	2.40	2.64	0.083	0.094	0.104

- STYLE 6:
PIN 1. BASE
2. EMITTER
3. COLLECTOR

SOLDERING FOOTPRINT*

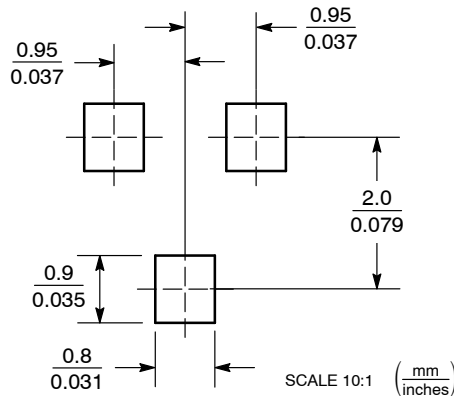

*For additional information on our Pb-Free strategy and soldering details, please download the ON Semiconductor Soldering and Mounting Techniques Reference Manual, SOLDERRM/D.

ON Semiconductor and are registered trademarks of Semiconductor Components Industries, LLC (SCILLC). SCILLC reserves the right to make changes without further notice to any products herein. SCILLC makes no warranty, representation or guarantee regarding the suitability of its products for any particular purpose, nor does SCILLC assume any liability arising out of the application or use of any product or circuit, and specifically disclaims any and all liability, including without limitation special, consequential or incidental damages. "Typical" parameters which may be provided in SCILLC data sheets and/or specifications can and do vary in different applications and actual performance may vary over time. All operating parameters, including "Typicals" must be validated for each customer application by customer's technical experts. SCILLC does not convey any license under its patent rights nor the rights of others. SCILLC products are not designed, intended, or authorized for use as components in systems intended for surgical implant into the body, or other applications intended to support or sustain life, or for any other application in which the failure of the SCILLC product could create a situation where personal injury or death may occur. Should Buyer purchase or use SCILLC products for any such unintended or unauthorized application, Buyer shall indemnify and hold SCILLC and its officers, employees, subsidiaries, affiliates, and distributors harmless against all claims, costs, damages, and expenses, and reasonable attorney fees arising out of, directly or indirectly, any claim of personal injury or death associated with such unintended or unauthorized use, even if such claim alleges that SCILLC was negligent regarding the design or manufacture of the part. SCILLC is an Equal Opportunity/Affirmative Action Employer. This literature is subject to all applicable copyright laws and is not for resale in any manner.

PUBLICATION ORDERING INFORMATION

LITERATURE FULFILLMENT:
Literature Distribution Center for ON Semiconductor
P.O. Box 5163, Denver, Colorado 80217 USA
Phone: 303-675-2175 or 800-344-3860 Toll Free USA/Canada
Fax: 303-675-2176 or 800-344-3867 Toll Free USA/Canada
Email: orderlit@onsemi.com

N. American Technical Support: 800-282-9855 Toll Free
USA/Canada
Europe, Middle East and Africa Technical Support:
Phone: 421 33 790 2910
Japan Customer Focus Center
Phone: 81-3-5773-3850

ON Semiconductor Website: www.onsemi.com

Order Literature: <http://www.onsemi.com/orderlit>

For additional information, please contact your local Sales Representative