

STR9 Dongle hardware description

Introduction

This user manual provides a hardware description of both versions of the STR9 Dongle:

- STEVAL-IFD001V1 (full version)
- STEVAL-IFD001V2 (lite version)

Figure 1. STR9 DONGLE (STEVAL-IFD001V2)

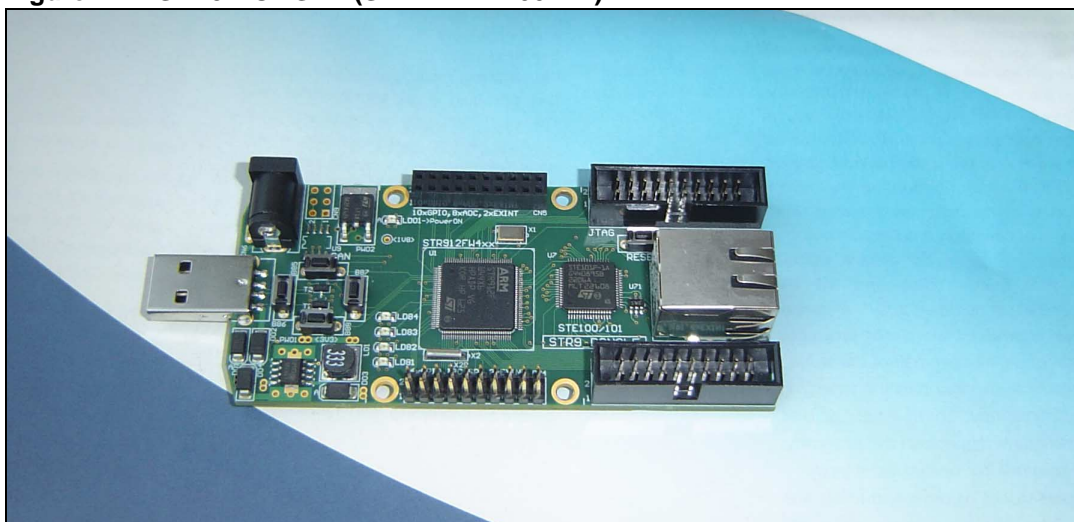

This document contains all the necessary assembly information to designers interested in using STR9 Dongle including the block diagram, board schematics, footprints and PCB layouts as well as the bill of materials and any additional assembly instructions.

Contents

1	STR9 Dongle	3
1.1	Block diagram	3
1.2	Schematics	4
1.2.1	Pin connections	8
1.3	Suppliers	9
1.4	Used footprints	10
1.5	PCB layout	11
1.6	Bill of materials	13
1.7	Assembling instructions	16
1.7.1	Assembling of resistors	16
1.8	Assembling instructions for lite version	17
1.9	Application hints	17
1.9.1	Ethernet interface	17
1.9.2	USB interface	17
2	Revision history	18

1 STR9 Dongle

1.1 Block diagram

This board is based on an STR912FAW34, STR912FAW42 or STR912FAW44 microcontroller which provides calculation power up to 90MIPS.

STR912FAW34, STR912FAW42 and STR912FAW44 are referred to STR912FAWxx throughout the document.

Figure 2. STR9 Dongle block diagram

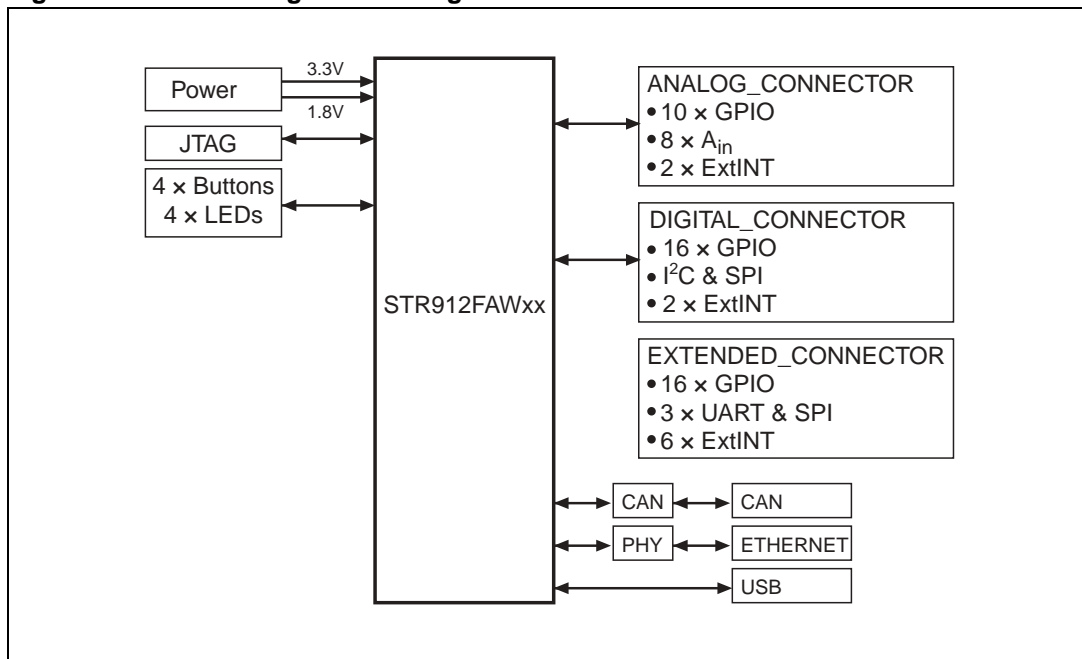

Main board features

- 42x GPIOs
- 3x UARTs
- I²C
- 2x SPI
- 1x CAN
- 8x ADC
- USB slave (full-speed)
- Ethernet (STE100 or STE101)

Examples of available extended extensions:

- STR9 Flash Extension
- STR9 LCD Extension
- STR9 MEMS Extension

1.2 Schematics

Figure 3. Schematics 1 of 4

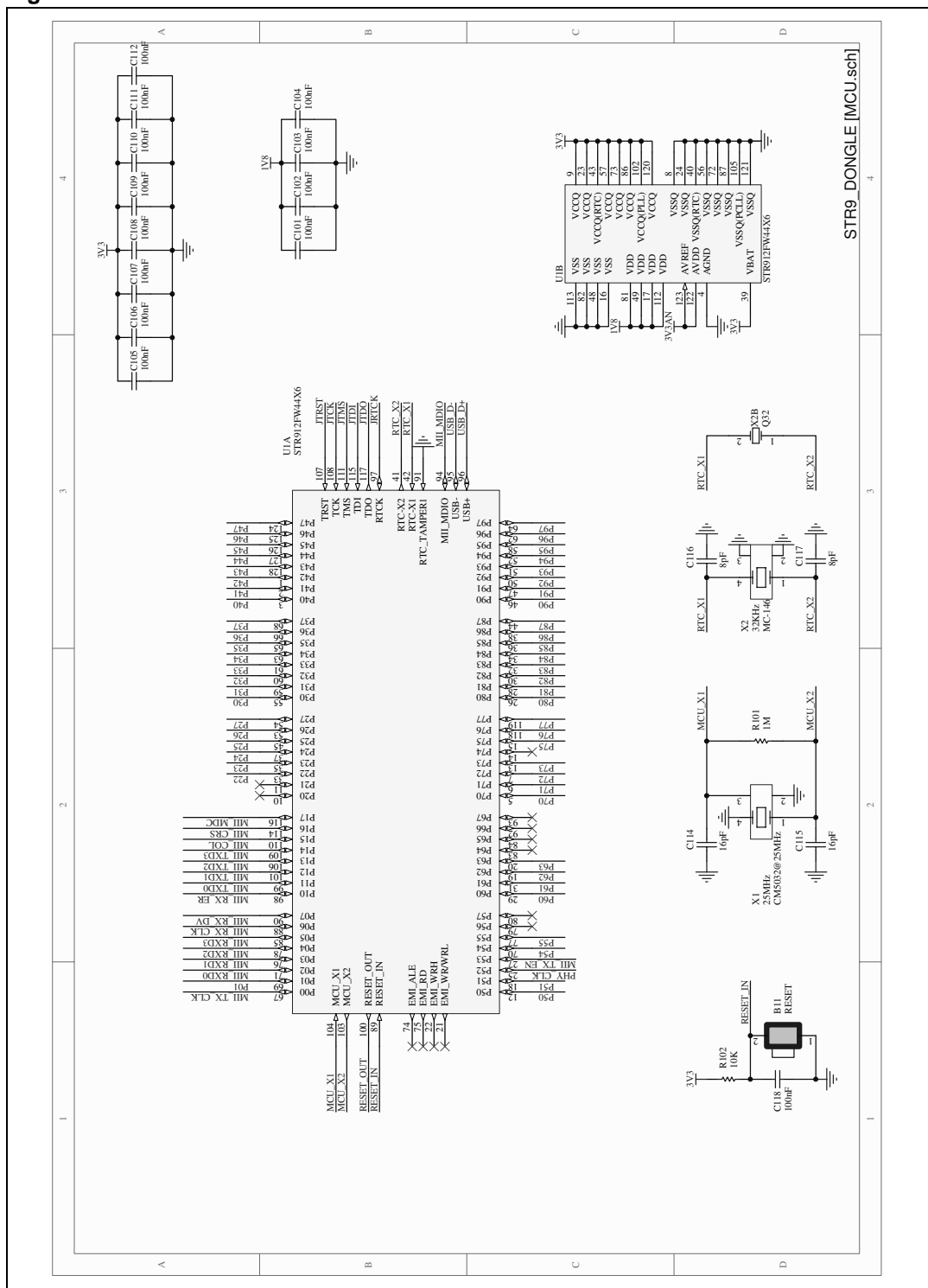

Figure 4. Schematics 2 of 4

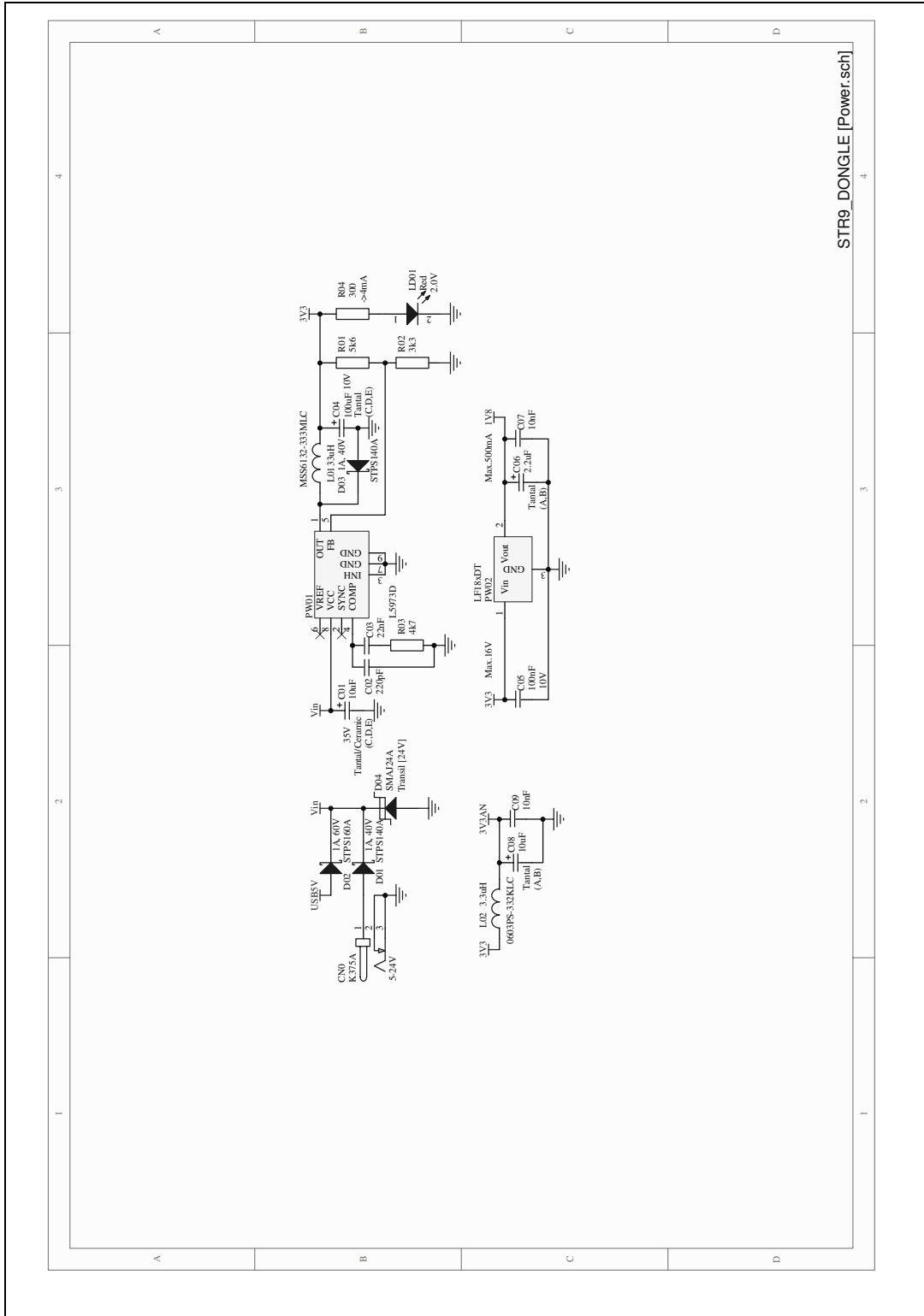
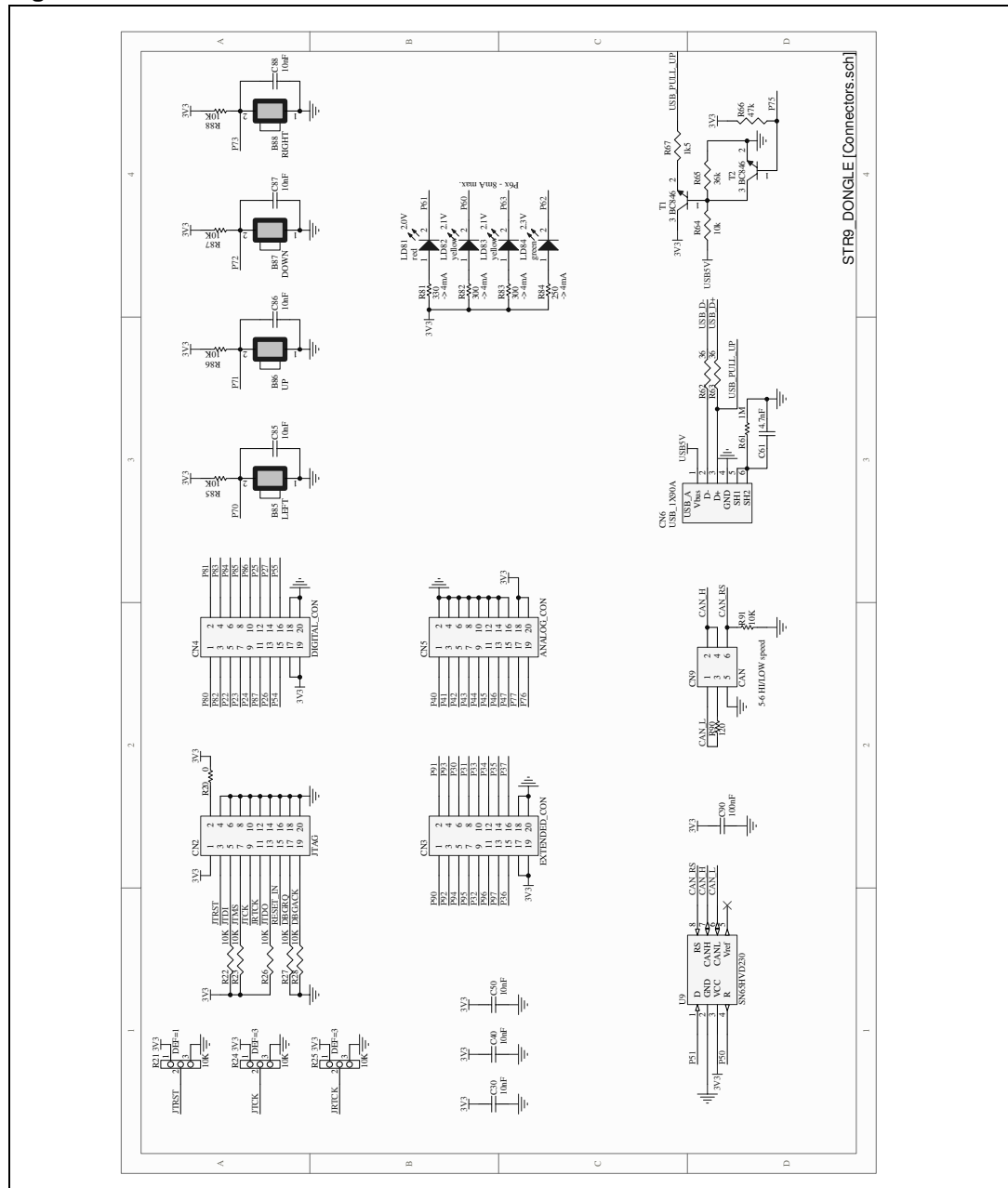
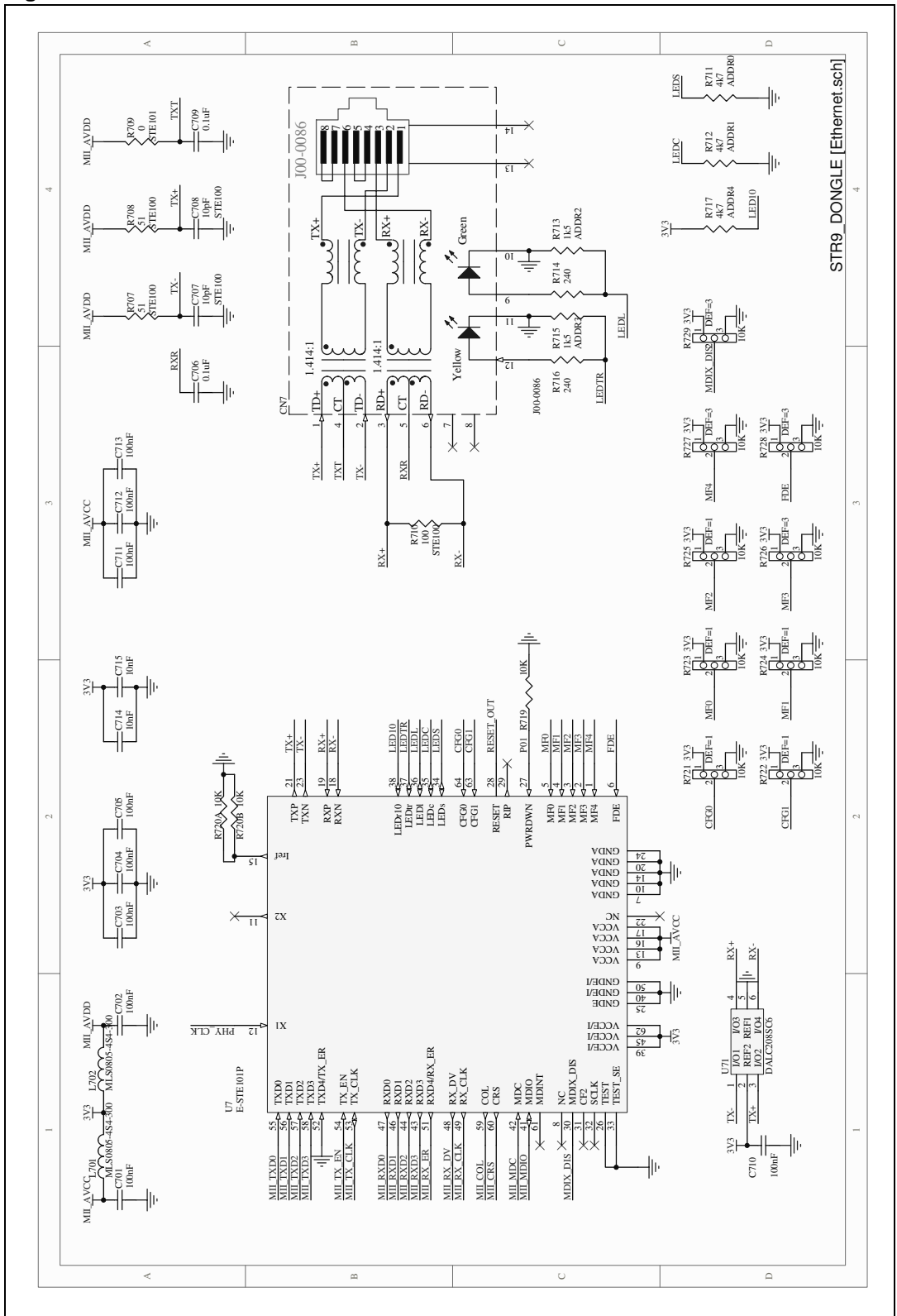

Figure 5. Schematics 3 of 4



Note: Refer to [Section 1.2.1 on page 8](#) for pin connections of CN3, CN4 and CN5 connectors.

Figure 6. Schematics 4 of 4



1.2.1 Pin connections

The following tables show the pin connections for the three connectors ANALOG_CON (CN5), DIGITAL_CON (CN4) and EXTENDED_CON (CN3). These are shown in [Figure 5 on page 6](#).

Table 1. Analog connector, ANALOG_CON (CN5)

Pin	GPIO	INT	UART	SPI	I ² C	ADC
P40	In/Out	-	-	-	-	ADC0
P41	In/Out	-	-	-	-	ADC1
P42	In/Out	-	-	-	-	ADC2
P43	In/Out	-	-	-	-	ADC3
P44	In/Out	-	-	-	-	ADC4
P45	In/Out	-	-	-	-	ADC5
P46	In/Out	-	-	-	-	ADC6
P47	In/Out	-	-	-	-	ADC7
P77	In/Out	EXINT31	-	-	-	-
P76	In/Out	EXINT30	-	-	-	-

Table 2. Digital connector, DIGITAL_CON (CN4)

Pin	GPIO	INT	UART	SPI	I ² C	ADC
P80	In/Out	-	-	-	-	-
P81	In/Out	-	-	-	-	-
P82	In/Out	-	-	-	-	-
P83	In/Out	-	-	-	-	-
P22	In/Out	-	-	-	I2C1_CLK	-
P84	In/Out	-	-	-	-	-
P23	In/Out	-	-	-	I2C1_DATA	-
P85	In/Out	-	-	-	-	-
P24	In/Out	-	-	SSP0_SCLK	-	-
P86	In/Out	-	-	-	-	-
P87	In/Out	-	-	-	-	-
P25	In/Out	-	-	SSP0_MOSI	-	-
P26	In/Out	-	-	SSP0_MISO	-	-
P27	In/Out	-	-	SSP0_NSS	-	-
P54	In/Out	EXINT12	-	-	-	-
P55	In/Out	EXINT13	-	-	-	-

Table 3. Extended connector, EXTENDED_CON (CN3)

Pin	GPIO	INT	UART	SPI	I ² C	ADC
P90	In/Out	-	-	-	-	-
P91	In/Out	-	-	-	-	-
P92	In/Out	-	-	-	-	-
P93	In/Out	-	-	-	-	-
P94	In/Out	-	-	-	-	-
P30	In/Out	-	UART0_RX UART2_TX	-	-	-
P95	In/Out	-	-	-	-	-
P31	In/Out	-	UART2_RX UART0_TX	-	-	-
P32	In/Out	EXINT2	UART1_RX	-	-	-
P33	In/Out	EXINT3	UART1_TX	-	-	-
P96	In/Out	-	-	-	-	-
P34	In/Out	EXINT4	-	SSP0_SCLK	-	-
P97	In/Out	-	-	-	-	-
P35	In/Out	EXINT5	-	SSP0_MISO	-	-
P36	In/Out	EXINT6	-	SSP0_MOSI	-	-
P37	In/Out	EXINT7	-	SSP0_NSS	-	-

1.3 Suppliers

KOALA	www.koala.cz
GME	www.gme.cz
FARNELL	www.farnellinone.cz
TAIYO YUDEN	www.t-yuden.com
WURTH ELEKTRONIK:	www.wuerth-elektronik.de
PULSE	www.pulseeng.com/
COILCRAFT	www.coilcraft.com

1.4 Used footprints

www.koala.cz: CM5032

www.koala.cz: MC-146

Terminal wraparound: approx 0.012/0,30 both ends

A max	B max	C max	D	E	F	G	H	I	J
0.102	0.082	0.071	0.049	0.030	0.060	0.013	0.040	0.025	0.025
2,59	2,08	1,80	1,24	0,76	1,52	0,33	1,02	0,64	0,64

www.coilcraft.com: 0603PS-332KLC

1.5 PCB layout

Figure 7. Top view

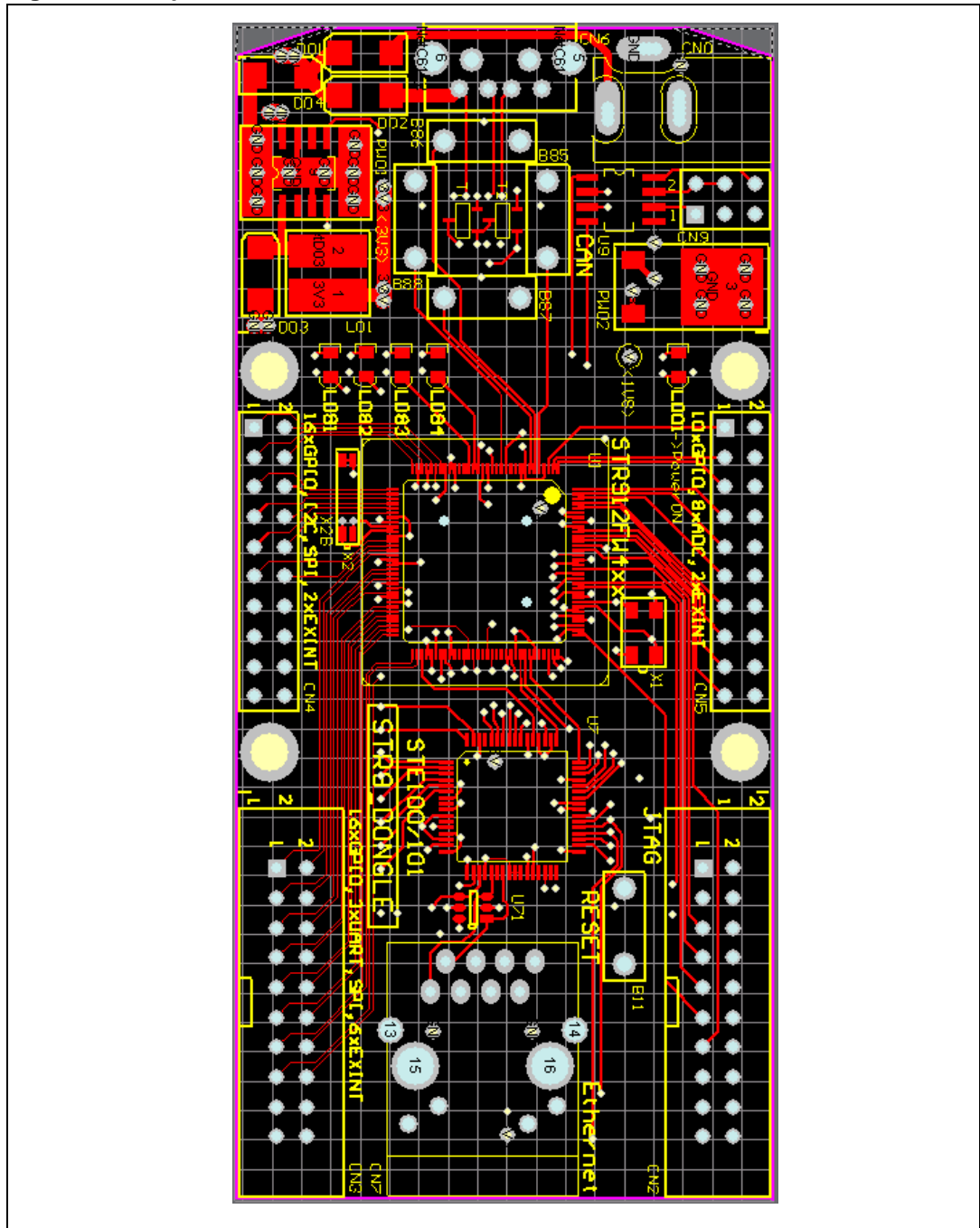
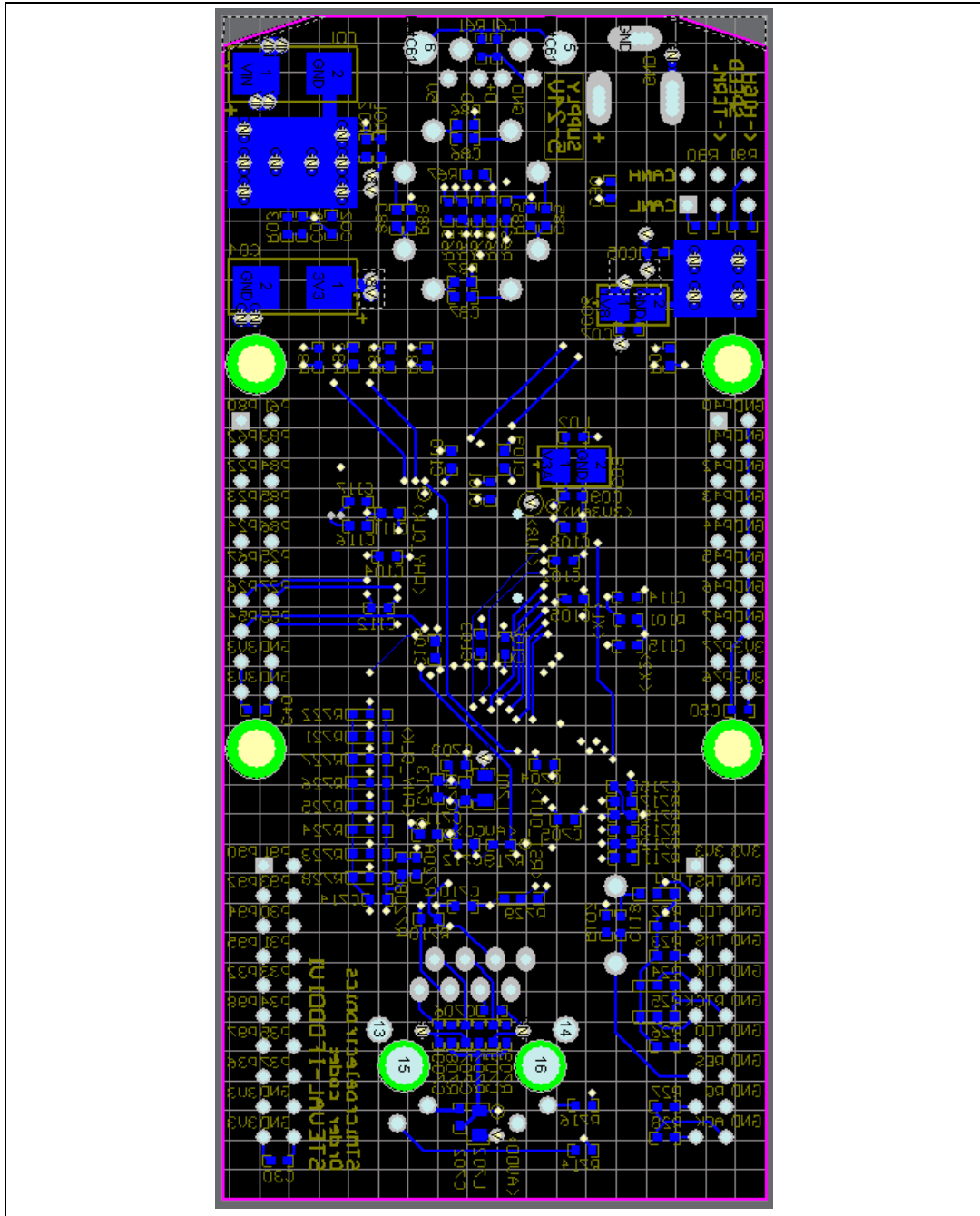

Figure 8. Bottom view



1.6 Bill of materials

Table 4. Chips

Part	Package	Detail description	Order code
U1	LQFP128	STR912FAW34, STR912FAW42, STR912FAW44	ST: STR912FAW34x6, STR912FAW42x6, STR912FAW44x6
U7	TQFP64	Ethernet physical layer	ST: STE100 or STE101
U71	SOT23-6L	DALC208 diode protection	ST: DALC208SC6
U9	SO8	CAN transceiver (3V)	Farnell: 501-1954 (SN65HVD230-232)

Table 5. Capacitors

Part	Package	Detail description	Order code
C114, C115,	0603	18 pF (16-22 pF), ceramic	
C116, C117	0603	10 pF (8-16 pF), ceramic	Farnell: 422-6768 (NPO, 50 V)
C707, C708 C30, C40, C50	0603	10 pF	Farnell: 422-6768 (NPO, 50 V)
C03	0603	22 pF	Farnell: 422-6770 (NPO, 50 V)
C02	0603	220 pF	Farnell: 422-6811 (NPO, 50 V)
C61	0603	4.7 nF, ceramic	Farnell: 422-6926 (X7R, 50 V)
C07, C09, C714-C715, C85-C88	0603	10 nF	Farnell: 422-6938 (X7R, 50 V)
C05, C118, C701-C705, C706, C709, C711-C713, C90, C101-C112, C710	0603	100 nF	Farnell: 422-6859 (X7R, 16 V)
C06	AB	2.2 μ F	Farnell: 757-720 (STD, 10 V)
C08	AB	10 μ F	Farnell: 331-3888 (STD, 10 V)
C01	CDE	10 μ F, 35V, Tantal or ceramic	Farnell: 331-4145 (LowESR, 35 V) Taiyo: CE GMK325 F106ZH-T
C04	CDE	100 μ F, 10V, Tantal	Farnell: 331-4066 (LowESR, 10 V)

Table 6. Xtals

Part	Package	Detail description	Order code
X1	-	25 MHz	KOALA: 25MHz CM5032
X2 X2B	-	32 kHz	KOALA: 32.768 MC146 GM: 131-082 (Q32.768KHZM)

Table 7. Resistors

Part	Package	Detail description	Order code
R709, R20	0603	0	GM: R0603-0R
R62-R63	0603	36	GM: R0603-36R
R707, R708	0603	51	GM: R0603-51R
R710	0603	100	GM: R0603-100R
R90	0603	120	GM: R0603-120R
R714, R716	0603	240	GM: R0603-240R
R84	0603	270	GM: R0603-240R
R82, R83,	0603	390	GM: R0603-300R
R81, R04	0603	330	GM: R0603-330R
R67, R713, R715	0603	1k5	GM: R0603-1K5
R02	0603	3k3	GM: R0603-3K3
R711, R712, R717, R03	0603	4k7	GM: R0603-4K7
R01	0603	5k6	GM: R0603-5K6
R102, R64 R719, R721-R729, R91, R85-R88, R21-R28	0603	10k	GM: R0603-10K
R101, R61	0603	1M	GM: R0603-1M
R65	0603	36k	GM: R0603-36K
R66	0603	47k	GM: R0603-47K
R720A, 720B	0603	10k	GM: R0603-10K 1%

Table 8. Connectors

Part	Package	Detail description	Order code
CN0	TAP_2.5mm	Connector	GM: K375A
CN2, CN3	2.54mm	Connector, 2x10pins	GM: MLW20G
CN4	2.54mm	2x10pin header	GM: S2G20
CN5	2.54mm	2x10pin header	GM: BL220G
CN6	USB_A	USB connector	GM: USB-1X90A
CN7		Ethernet Connector with integrated transformer	Pulse: J00-0086
CN9	2.54mm	6pin header	GM: S2G20 (cut to 6pin)

Table 9. Power

Part	Package	Detail description	Order code (reference)
PW01	SO8cool	$V_{OUT} = 3.3\text{ V}$, typ. 200 mA, max. 500 mA	ST: E-L5973D ($V_{INmax} = 35\text{ V}$, $I_{max} = 2.5\text{ A}$, $R_{th} = 40\text{ C/W}$) Use external supply 5-24V)
PW02	DPAK	$V_{OUT} = 1.8\text{ V}$, typ. 100 mA, 0.15 W	ST: LF18xDT ($V_{INmax} = 16\text{ V}$, $I_{max} = 1\text{ A}$, $R_{th} = 8\text{ C/W}$)

Table 10. Buttons

Part	Package	Detail description	Order code (reference)
B11, B85-B88	-	Button	GM: P-DT2112C

Table 11. Transistors

Part	Package	Detail description	Order code
T1,T2	SOT23-3	NPN universal transistor	GM: BC846A or compatible  1-Base, 2-Emitter, 3-Collector

Table 12. LEDs & diodes & tranzils

Part	Package	Detail description	Order code
D01, D03	SMA	Shottky diode 1 A, 40 V	ST: STPS140A
D02	SMA	Shottky diode 1 A, 60 V	ST: STPS160A
D04	SMA	Transil, 24 V	ST: SMAJ24A
LD01, LD81	0805	Red LED diode, 2.0 V	GM: 960-024
LD82, LD83	0805	Yellow LED diode, 2.1 V	GM: 960-025
LD84	0805	Green LED diode, 2.3 V	GM: 960-023

Table 13. Inductors

Part	Package	Detail description	Order code
L01	MSS6132 6.1x6.1mm	33 μH , $I_{rms} = 1.6\text{ A}$	Coilcraft: MSS6132-333MLC (12-39 μH available)
L02	0603	3.3 μH , $I_{rms} = 0.5\text{ A}$	Coilcraft: 0603PS-332KLC
L701, L702	0805	SMD-Ferrit 33 μH : 30@100 MHz	Würth Elektronik: 74279206

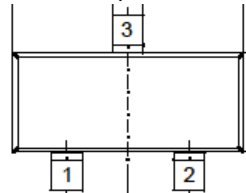
1.7 Assembling instructions

Table 14. JTAG with IAR

Part	Assembled	Configuration / Comment
R21	YES	Position 1-2
R24, R25	YES	Position 2-3
R27, R28	NO	
R20	YES	

Table 15. Configuration with STE101P

Part	Assembled	Configuration / Comment
R710	NO	
R707, R708	NO	
R709	YES	
R721-R725	YES	Position 1-2
R726-R729	YES	Position 2-3

1.7.1 Assembling of resistors

The marking (from top to bottom) is following: 3-2-1.

Figure 9. Resistor assembly

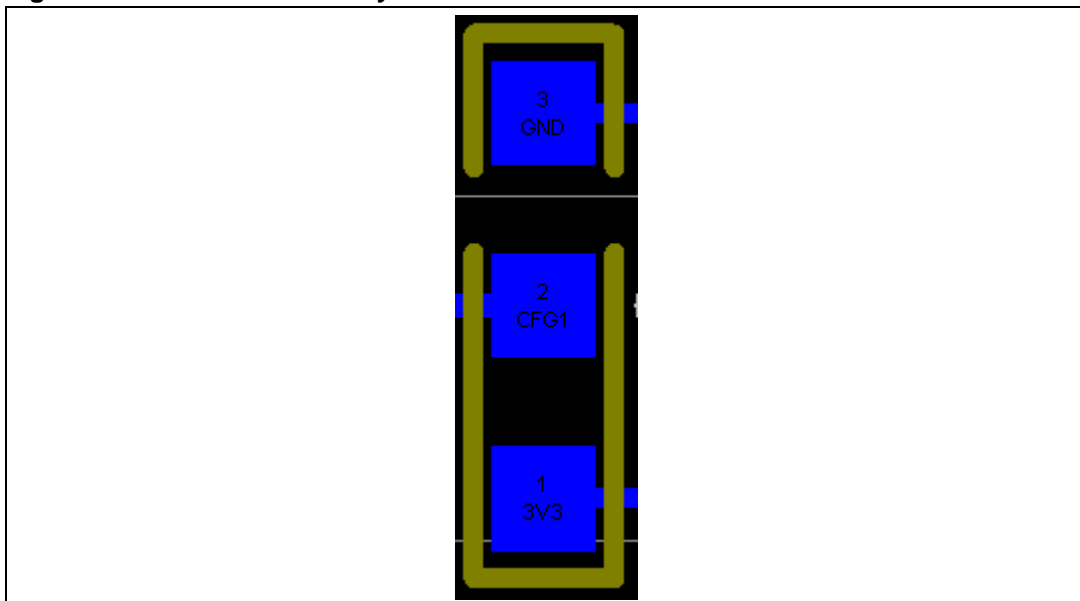

Possible assembling positions are:

- a) 1-2
- b) 2-3

1.8 Assembling instructions for lite version

- CAN transceiver U9 – not assembled
- Connectors CN3, CN4, CN5, CN9 – not assembled
- Crystal X2 – use this one GM: 131-082 (Q32.768KHZM)

1.9 Application hints

1.9.1 Ethernet interface

Clock input

The clock is provided directly by the STR912FAWxx device. It is mandatory to enable this feature on pin P52 before starting.

Address inputs

The DMA address is fixed and set to 0x10. It is defined by configuring resistors R711, R712, R713, R715, and R717.

Reset

The reset input is connected to STR912FAWxx Reset-out pin.

Power-down

The STR912FAWxx can be quickly put in Power-down mode by using the P01 pin. After a Reset, P01 is configured as an input and R719 acts as a pull-down resistor, thus making the PHY active by default. To put the PHY into Power-down mode, P01 must be configured as a push-pull output and held High.

1.9.2 USB interface

Disconnect on demand

The pull-up resistor R67 is driven by P75 pin. It tells the host whether the device is connected or not. After a Reset, P75 is configured as an input, which means that T2 is open and T1 closed. R67 consequently does not act as a pull-up resistor thus making the device disconnected by default. It is mandatory to configure pin P75 as an output (open-collector) and hold it Low before starting using the USB interface.

2 Revision history

Table 16. Document revision history

Date	Revision	Changes
19-Jan-2007	1	Initial release.
24-May-2007	2	<i>Section 1.9: Application hints</i> added.
19-June-2007	3	<i>Figure 1: STR9 DONGLE (STEVAL-IFD001V2)</i> updated. Root part numbers changed from STR912FW42xx and STR912FW44x to STR912FAW34, STR912FAW42 and STR912FAW44 throughout the document. <i>Table 4: Chips</i> updated.

Please Read Carefully:

Information in this document is provided solely in connection with ST products. STMicroelectronics NV and its subsidiaries ("ST") reserve the right to make changes, corrections, modifications or improvements, to this document, and the products and services described herein at any time, without notice.

All ST products are sold pursuant to ST's terms and conditions of sale.

Purchasers are solely responsible for the choice, selection and use of the ST products and services described herein, and ST assumes no liability whatsoever relating to the choice, selection or use of the ST products and services described herein.

No license, express or implied, by estoppel or otherwise, to any intellectual property rights is granted under this document. If any part of this document refers to any third party products or services it shall not be deemed a license grant by ST for the use of such third party products or services, or any intellectual property contained therein or considered as a warranty covering the use in any manner whatsoever of such third party products or services or any intellectual property contained therein.

UNLESS OTHERWISE SET FORTH IN ST'S TERMS AND CONDITIONS OF SALE ST DISCLAIMS ANY EXPRESS OR IMPLIED WARRANTY WITH RESPECT TO THE USE AND/OR SALE OF ST PRODUCTS INCLUDING WITHOUT LIMITATION IMPLIED WARRANTIES OF MERCHANTABILITY, FITNESS FOR A PARTICULAR PURPOSE (AND THEIR EQUIVALENTS UNDER THE LAWS OF ANY JURISDICTION), OR INFRINGEMENT OF ANY PATENT, COPYRIGHT OR OTHER INTELLECTUAL PROPERTY RIGHT.

UNLESS EXPRESSLY APPROVED IN WRITING BY AN AUTHORIZED ST REPRESENTATIVE, ST PRODUCTS ARE NOT RECOMMENDED, AUTHORIZED OR WARRANTED FOR USE IN MILITARY, AIR CRAFT, SPACE, LIFE SAVING, OR LIFE SUSTAINING APPLICATIONS, NOR IN PRODUCTS OR SYSTEMS WHERE FAILURE OR MALFUNCTION MAY RESULT IN PERSONAL INJURY, DEATH, OR SEVERE PROPERTY OR ENVIRONMENTAL DAMAGE. ST PRODUCTS WHICH ARE NOT SPECIFIED AS "AUTOMOTIVE GRADE" MAY ONLY BE USED IN AUTOMOTIVE APPLICATIONS AT USER'S OWN RISK.

Resale of ST products with provisions different from the statements and/or technical features set forth in this document shall immediately void any warranty granted by ST for the ST product or service described herein and shall not create or extend in any manner whatsoever, any liability of ST.

ST and the ST logo are trademarks or registered trademarks of ST in various countries.

Information in this document supersedes and replaces all information previously supplied.

The ST logo is a registered trademark of STMicroelectronics. All other names are the property of their respective owners.

© 2007 STMicroelectronics - All rights reserved

STMicroelectronics group of companies

Australia - Belgium - Brazil - Canada - China - Czech Republic - Finland - France - Germany - Hong Kong - India - Israel - Italy - Japan - Malaysia - Malta - Morocco - Singapore - Spain - Sweden - Switzerland - United Kingdom - United States of America

www.st.com