

LT1510 Constant-Voltage/ Constant-Current Lithium-Ion Battery Charger

DESCRIPTION

Demonstration board DC086 is a complete lithium-ion battery charger designed for 1-, 2- or 3-cell applications (other rechargeable battery types can also be charged, see page three). The LT[®]1510 is used in a high efficiency current mode step-down switching topology, capable of providing up to 1.5A of charging current. This demo board uses all surface mount components, resulting in a circuit occupying approximately 1 square inch of board area with less than 0.3 in. (7.6mm) height.

Jumpers J1 and J2, located on the demo board, are used to select the correct charging voltage for the number of

cells being charged (4.2V, 8.4V or 12.6V). Charging current is programmed for 1.3A by resistor R1.

The DC input voltage must be at least 3V greater than the output voltage. When the input voltage is removed, an external low current MOSFET (Q1) provides a disconnect for the output voltage divider resistors and the chip goes into a sleep mode, draining approximately 3 μ A from the battery.

 LTC and LT are registered trademarks of Linear Technology Corporation.

PERFORMANCE SUMMARY

| PARAMETER | CONDITIONS | LIMITS |
|-----------------------------------------------------------|----------------------------------------------------|-------------------------------------------------------|
| V_{IN} | | $V_{OUT} + 3V \leq V_{IN} \leq 28V^*$ |
| Battery Voltage (V_{BAT}) When Charging Terminates | $V_{IN} = 10V$ $V_{IN} = 15V$ $V_{IN} = 20V$ | 4.2 \pm 0.7% 8.4V \pm 0.7% 12.6V \pm 0.7% |
| Maximum Battery Charging Current | | 1.3A \pm 5% |

Note: Good thermal PC board layout techniques are required when operating near maximum power levels to prevent excessive junction temperatures.

Note: For 0.5% battery-voltage accuracy, replace R3 to R8 with 0.1% resistors.

*For $V_{IN} > 25V$, C1 should be replaced with a higher voltage rating capacitor.

TYPICAL PERFORMANCE CHARACTERISTICS AND BOARD PHOTO

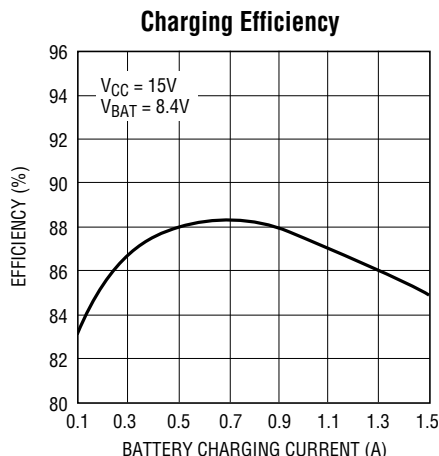

DM086 • TPC01

Component Side Demo Board

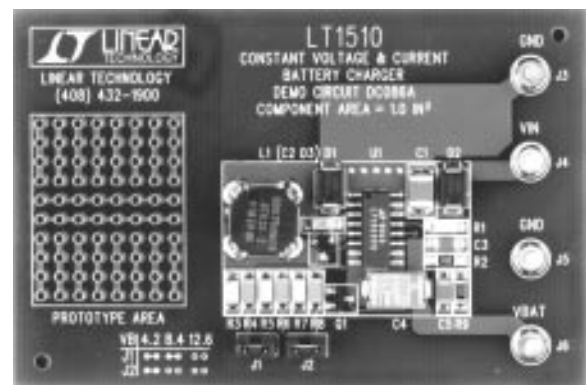

DEMO MANUAL DC086

BATTERY CHARGER

PACKAGE AND SCHEMATIC DIAGRAMS

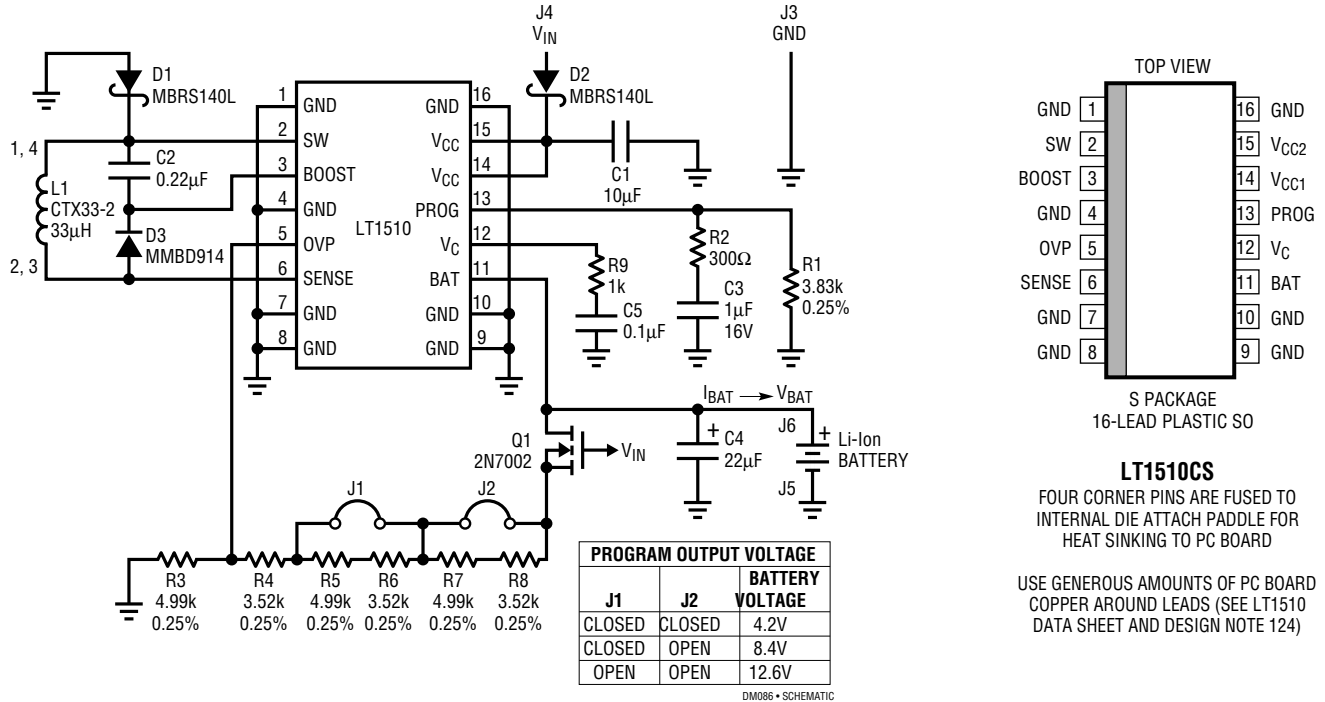

Figure 1. Demo Board Schematic

PARTS LIST

| REFERENCE DESIGNATOR | QUANTITY | PART NUMBER | DESCRIPTION | VENDOR | TELEPHONE |
|----------------------|----------|------------------------------------|--------------------------------------|---------------------------------|----------------------------------|
| C1 | 1 | 1E106ZY5U-C304F-T THCS50EIE106Z | 10µF 25V 20% Y5U Ceramic Capacitor | Tokin United Chemicon/Marcon | (408) 432-8020 (708) 696-2000 |
| C2 | 1 | 12063C224MAT2A | 0.22µF 25V 20% X7R Ceramic Capacitor | AVX | (207) 282-5111 |
| C3 | 1 | 1206YG105ZAT2A | 1µF 16V Y5V Ceramic Capacitor | AVX | (207) 282-5111 |
| C4 | 1 | TPSD226M025R0200 | 22µF 25V 20% Tantalum Capacitor | AVX | (207) 282-5111 |
| C5 | 1 | 12065C104MAT2A | 0.1µF 50V 20% X7R Ceramic Capacitor | AVX | (207) 282-5111 |
| D1, D2 | 2 | MBRS140LT3 | 1A 40V Schottky Diode | Motorola | (602) 244-3550 |
| D3 | 1 | MMBD914LT1 | 100V Silicon Diode | Motorola | (602) 244-3550 |
| J1, J2 | 2 | TSW-102-07-G-S | 0.1"cc, 0.025"sq. 2-Pin Jumper | Samtech | (800) 726-8329 |
| J3 to J6 | 4 | 1502-2 | 0.090" Turret Terminal | Keystone | (718) 956-8900 |
| L1 | 1 | CTX33-2 | 33µH 2A SMT Inductor | Coiltronics | (407) 241-7876 |
| Q1 | 1 | 2N7002 | N-Channel MOSFET Transistor | Siliconix | (800) 554-5565 |
| R1 | 1 | CR1206F3K83CT | 3.83k 1/4W 0.25% Chip Resistor | IRC | (512) 992-7900 |
| R2 | 1 | CR32-301J-T | 300Ω 1/8W 5% Chip Resistor | AVX | (207) 282-5111 |
| R3, R5, R7 | 3 | CR1206F4K99CT | 4.99k 1/4W 0.25% Chip Resistor | IRC | (512) 992-7900 |
| R4, R6, R8 | 3 | CR1206F3K52CT | 3.52k 1/4W 0.25% Chip Resistor | IRC | (512) 992-7900 |
| R9 | 1 | CR32-102J-T | 1k 1/8W 5% Chip Resistor | AVX | (207) 282-5111 |
| U1 | 1 | LT1510CS | SO-16 Battery Charger IC | LTC | (408) 432-1900 |

OPERATION

The DC086 demonstration board is intended for evaluating the LT1510 switching regulator battery charger IC. Solder terminals are provided for easy hookup to a power supply and to a lithium-ion battery to be charged. The correct charging voltage for either 1, 2 or 3 cells is selectable by a combination of jumpers (J1 and J2) on the board. See the schematic diagram for jumper information. Current limit is set for 1.29A by resistor R1.

With a suitable input power supply and a discharged battery connected to the demo board, the battery will begin charging at the programmed current limit of 1.29A. As the battery charges, the voltage rises and approaches the program voltage of either 4.2V, 8.4V or 12.6V. The charger will then maintain a constant voltage across the battery, with the charging current decreasing to zero over time as the battery reaches a fully charged condition.

The IC goes into a sleep mode when the input voltage is removed. In the sleep mode, the drain from the battery due to the LT1510 is approximately 3 μ A. An additional source of battery drain is due to the leakage current of Schottky diode D1. Selecting a low leakage Schottky diode such as a Motorola MBRD340 or a low leakage 3A silicon diode can minimize this current drain.

Some lithium-ion battery manufacturers recommend terminating the constant-voltage float mode after the charge current has dropped below a specific level (typically 50mA to 100mA) and a specific amount of time has elapsed (typically from 30 to 90 minutes). This may extend the life of the battery, but check with the manufacturer of the battery you are using for details. Included on the board is an area for breadboarding a timing circuit.

Other Battery Types

Although the demo board was designed for charging Li-Ion batteries, simple modifications will allow other battery types to be charged.

Sealed lead-acid batteries are charged using a current-limited constant voltage. Over a 0°C to 40°C temperature range, a charge voltage of 2.35V/cell can be used with no charge termination needed. The maximum charge current is determined by the battery manufacturer and is typically 0.25C or less. To use the demo board for charging sealed

Note: C is the capacity rating of the battery in Ampere-Hours.

lead-acid batteries, reprogram the OVP (overvoltage protection) feedback resistor divider for the correct battery charging voltage using the following formula:

$$R_F = R_3 \left(\frac{V_{OUT}}{V_{REF}} - 1 \right)$$

where R_F = total resistance between OVP pin and BAT pin, V_{REF} = 2.465V, select R_3 = 4.99k, 1% or less.

Maximum charging current (up to 1.5A) is programmed by R1 using the following formula:

$$R1 = \frac{(2000)(2.465)}{I_{CHARGE}}$$

where 2.465V = reference voltage present at PROG pin.

The maximum charging current (or current limit) is 2000 times the current out of the PROG pin. This current has both AC and DC components present; therefore, to provide high DC accuracy, averaging components R2 and C3 are required.

For nickel-cadmium and nickel-metal-hydride batteries, the normal charging method is constant current. Fast charging requires some method to detect full charge and terminate the high charge current. Some methods often used to indicate full charge include battery temperature rise and observing battery voltage profile during charging.

LT1510 Step-Down Switching Regulator

The LT1510 is designed for constant-voltage and/or constant-current operation with a 0.5% voltage accuracy and a 5% current accuracy. An external resistor voltage divider programs the output voltage, while a single resistor (or a programming current from a DAC) sets the maximum charging current.

An internal 2A NPN switch operating at 200kHz provides high efficiency with low inductor values using a minimum number of external components. The charging current sense resistor is included on the die and can be wired for sensing charging current at either the positive or negative side of the battery.

Refer to the LT1510 data sheet for complete product specifications and design notes DN111 and DN124 for additional application information.

DEMO MANUAL DC086 BATTERY CHARGER

PCB LAYOUT AND FILM

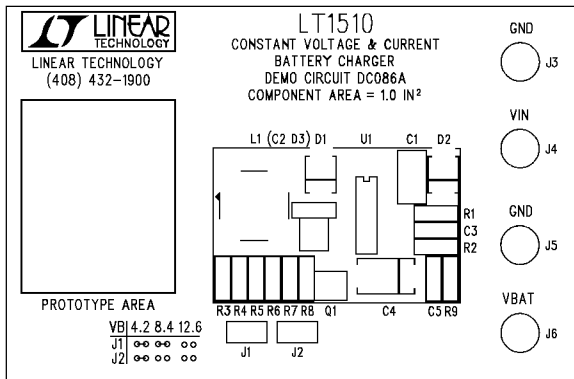

Component Side Silkscreen

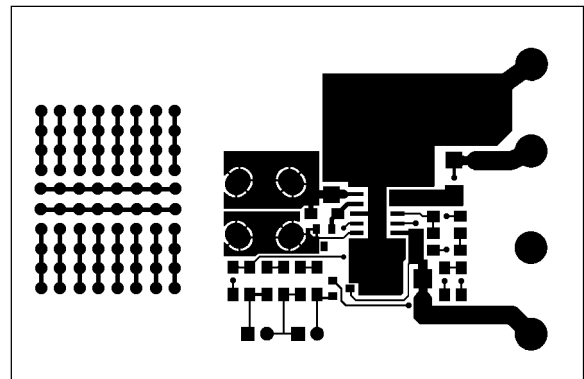

Component Side

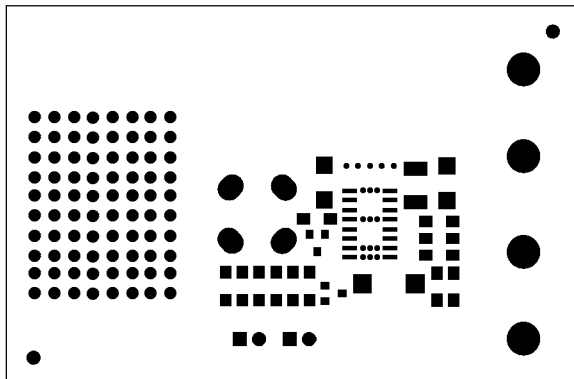

Component Side Solder Mask

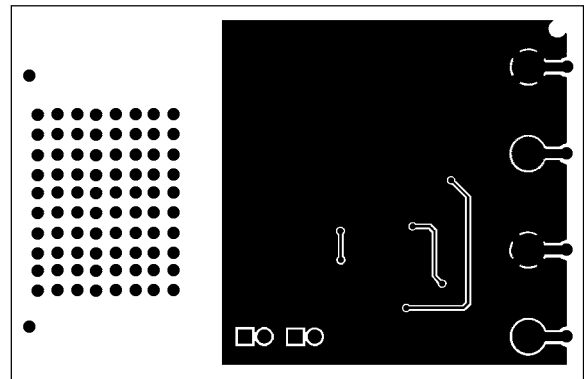

Solder Side

PC FAB DRAWING

| SYMBOL | DIAMETER | NUMBER OF HOLES |
|-------------|----------|-----------------|
| NONE | 0.010 | 10 |
| B | 0.015 | 17 |
| C | 0.035 | 80 |
| D | 0.040 | 4 |
| E | 0.095 | 4 |
| F | 0.070 | 2 |
| TOTAL HOLES | | 117 |

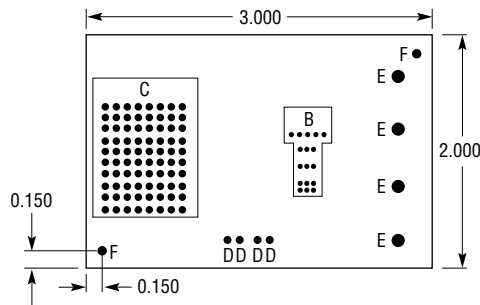

NOTES:

1. BOARD MATERIAL IS FR-4, 0.062" THICK, 2 OZ COPPER
2. PCB WILL BE DOUBLE-SIDED WITH PLATED THROUGH HOLES
3. SOLDER MASK BOTH SIDES WITH PC4014. SILKSCREEN COMPONENT SIDE. USE WHITE NONCONDUCTIVE INK
4. ALL DIMENSIONS IN INCHES $\pm 0.005"$

DC086 • PC DWG