

### PROTECTION PRODUCTS - RailClamp®

#### Description

RClamp®3521P provides ESD protection for USB3.0 and other high-speed ports. It may be used to meet the ESD immunity requirements of IEC 61000-4-2. RClamp3521P is designed to minimize both the ESD peak clamping and the TLP clamping. The dynamic resistance is minimized (0.47 Ohms typical) for optimum protection of sensitive circuits. Maximum capacitance is only 0.40pF. This allows the RClamp3521P to be used in applications operating in excess of 5GHz without appreciable signal attenuation. These devices are manufactured using Semtech's proprietary low voltage technology for superior electrical characteristics. RClamp3521P is in a 2-pin SLP1006P2 package. It measures 1.0 x 0.6 x 0.5mm. Leads are spaced at a pitch of 0.65mm and are finished with lead-free NiPdAu. Each device will protect one line operating up to 3.5 volts. The combination of low peak ESD clamping, low dynamic resistance, and low capacitance makes this device suitable for applications such as USB 3.0, audio and V-By-One interfaces in portable devices.

#### Features

- ◆ Transient protection for data lines to **IEC 61000-4-2 (ESD) ±17kV (air), ±12kV (contact) IEC 61000-4-4 (EFT) 40A (tp = 5/50ns) Cable Discharge Event (CDE)**
- ◆ Ultra-small package (1.0 x 0.6 x 0.5mm)
- ◆ Protects one data or I/O line
- ◆ Low capacitance: **0.40pF**
- ◆ Dynamic Resistance: 0.47 Ohms Typical
- ◆ Low ESD clamping voltage
- ◆ Operating voltage: 3.5V
- ◆ Solid-state silicon-avalanche technology

#### Mechanical Characteristics

- ◆ SLP1006P2 package
- ◆ Molding compound flammability rating: UL 94V-0
- ◆ Marking: Marking code
- ◆ Packaging: Tape and Reel
- ◆ Lead Finish: NiPdAu
- ◆ Pb-Free, Halogen Free, RoHS/WEEE Compliant

#### Applications

- ◆ USB 2.0 / USB 3.0
- ◆ V-By-One
- ◆ Display Port
- ◆ MHL / MDDI
- ◆ LVDS Interfaces
- ◆ eSATA Interfaces

#### Dimensions

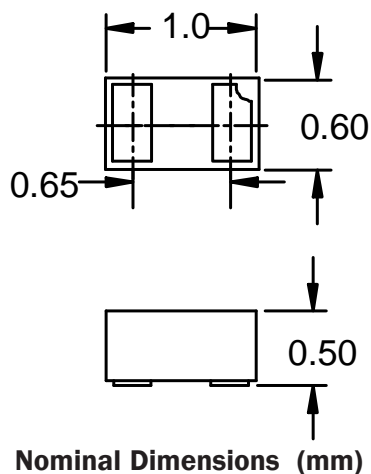

#### Schematic & Pin Configuration

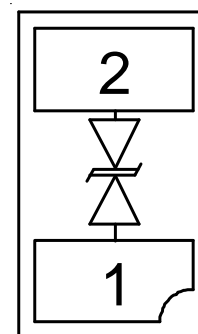

**SLP1006P2 (Bottom View)**

**PROTECTION PRODUCTS**
**Absolute Maximum Rating**

Rating	Symbol	Value	Units
Peak Pulse Power ( $t_p = 8/20\mu s$ )	$P_{pk}$	50	Watts
Maximum Peak Pulse Current ( $t_p = 8/20\mu s$ )	$I_{pp}$	4	Amps
ESD per IEC 61000-4-2 (Air) <sup>1</sup> ESD per IEC 61000-4-2 (Contact) <sup>1</sup>	$V_{ESD}$	+/- 17 +/- 12	kV
Operating Temperature	$T_J$	-40 to +125	°C
Storage Temperature	$T_{STG}$	-55 to +150	°C

**Electrical Characteristics (T=25°C)**

Parameter	Symbol	Conditions	Minimum	Typical	Maximum	Units
Reverse Stand-Off Voltage	$V_{RWM}$				3.5	V
Breakdown Voltage	$V_{BR}$	$I_{BR} = 1mA$	4.5	6.7	8.5	V
Reverse Leakage Current	$I_R$	$V_{RWM} = 3.5V$		0.01	0.05	$\mu A$
Clamping Voltage	$V_C$	$I_{pp} = 1A, t_p = 8/20\mu s$		9.5	10	V
Clamping Voltage	$V_C$	$I_{pp} = 4A, t_p = 8/20\mu s$		10.5	13	V
ESD Clamping Voltage <sup>2</sup>	$V_C$	$I_{pp} = 4A,$ $t_{lp} = 0.2/100ns$		8.8		V
ESD Clamping Voltage <sup>2</sup>	$V_C$	$I_{pp} = 16A,$ $t_{lp} = 0.2/100ns$		14.5		V
Trigger Voltage <sup>2</sup>	$V_{TRIG}$	$t_{lp} = 0.2/100ns$		8		V
Dynamic Resistance <sup>2, 3</sup>	$R_{DYN}$	$t_{lp} = 0.2 / 100ns$		0.47		Ohms
Junction Capacitance	$C_J$	$V_R = 0V, f = 1MHz$		0.33	0.40	pF

**Notes**

1)ESD gun return path connected to ESD ground reference plane.

2)Transmission Line Pulse Test (TLP) Settings:  $t_p = 100ns$ ,  $t_r = 0.2ns$ ,  $I_{TLP}$  and  $V_{TLP}$  averaging window:  $t_1 = 70ns$  to  $t_2 = 90ns$ .

3) Dynamic resistance calculated from  $I_{pp} = 4A$  to  $I_{pp} = 16A$

4) Device is electrically symmetrical

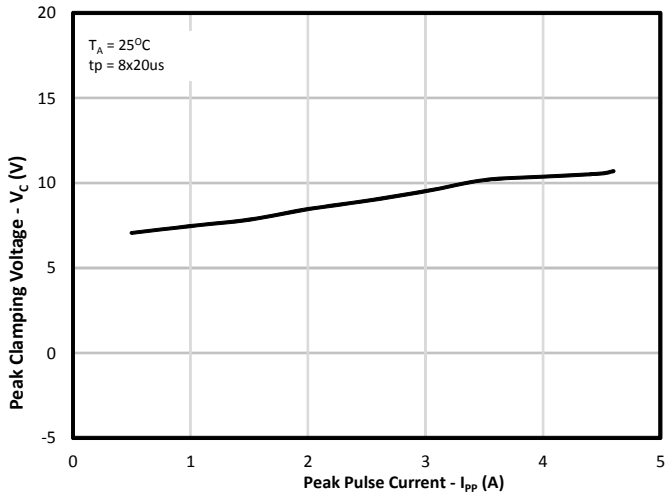
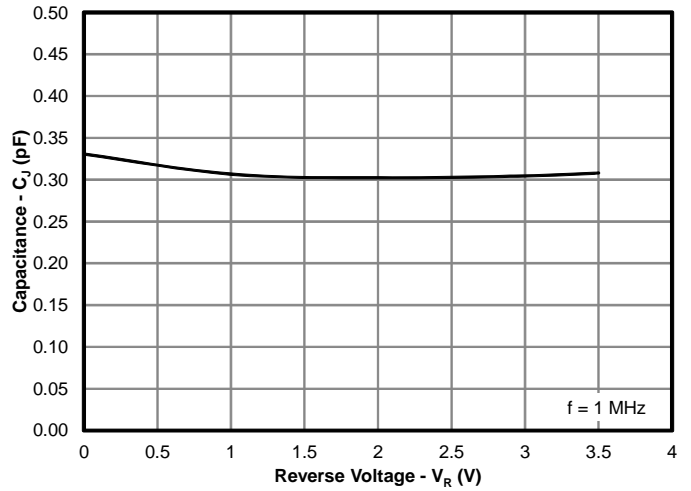
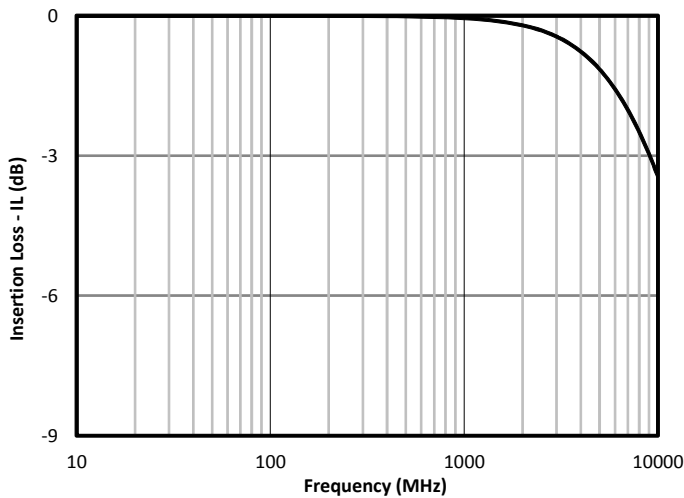
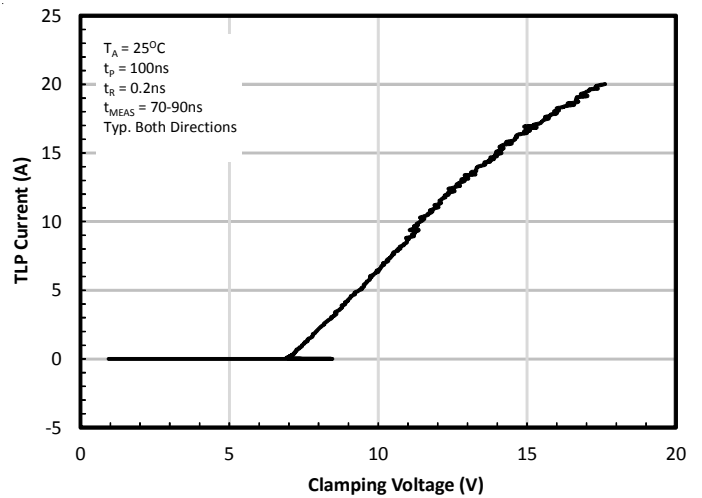
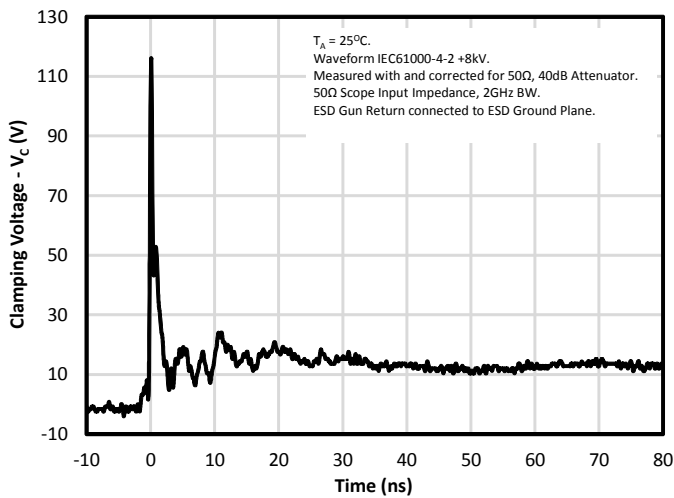
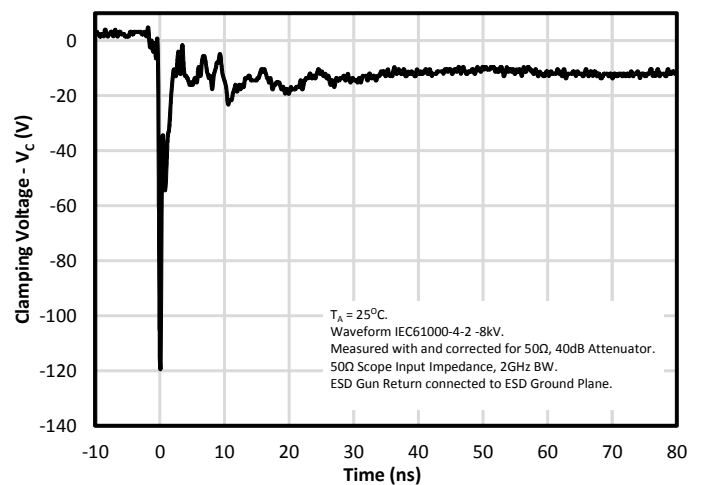
**PROTECTION PRODUCTS**
**Typical Characteristics**
**Clamping Voltage vs. Peak Pulse Current**

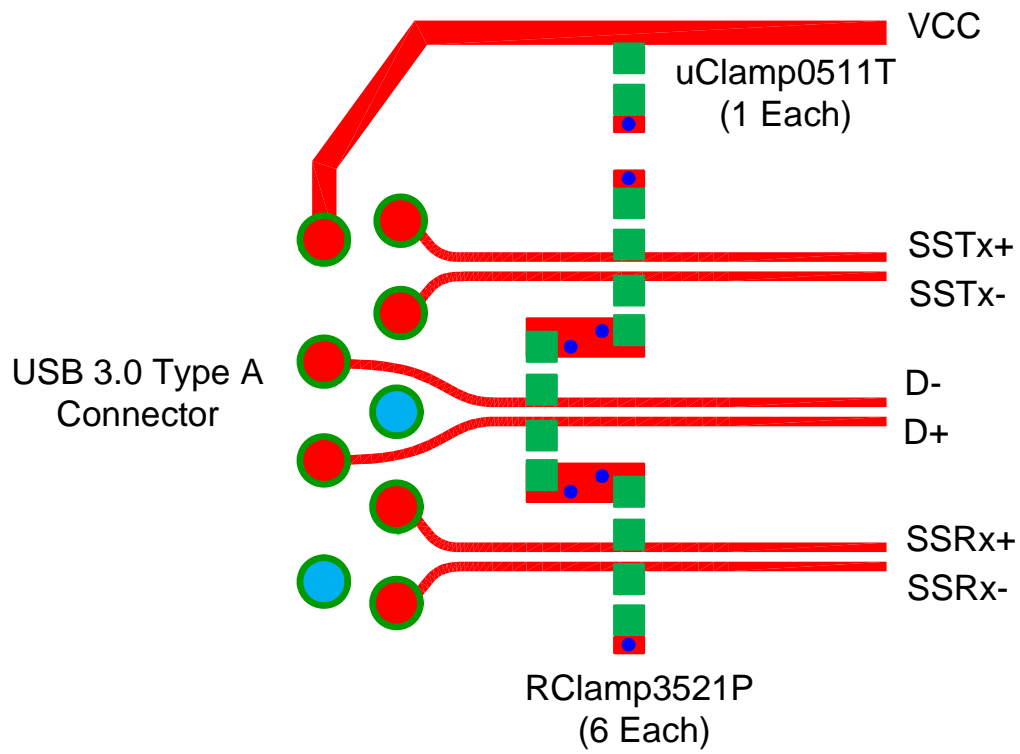
**Capacitance vs. Reverse Voltage**

**Typical Insertion Loss (S21)**

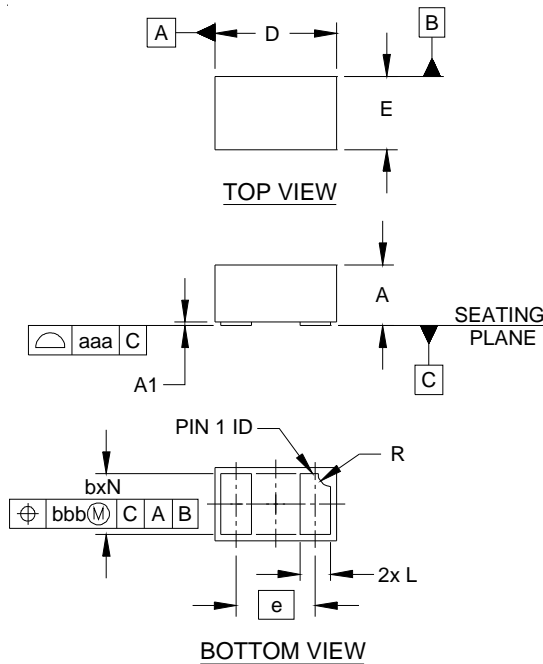
**TLP Characteristic**

**ESD Clamping (+8kV Contact per IEC 61000-4-2)**

**ESD Clamping (-8kV Contact per IEC 61000-4-2)**



**USB 3.0 Layout Diagram**

**PROTECTION PRODUCTS**
**Outline Drawing - SLP1006P2**

DIM	INCHES			MILLIMETERS		
	MIN	NOM	MAX	MIN	NOM	MAX
A	.016	.020	.022	0.40	0.50	0.55
A1	.000	.001	.002	0.00	0.03	0.05
b	.018	.020	.022	0.45	0.50	0.55
D	.035	.039	.043	0.90	1.00	1.10
E	.020	.024	.028	0.50	0.60	0.70
e	.026 BSC			0.65 BSC		
L	.008	.010	.012	0.20	0.25	0.30
R	.002	.004	.006	0.05	0.10	0.15
N	2			2		
aaa	.003			0.08		
bbb	.004			0.10		

**NOTES:**

1. CONTROLLING DIMENSIONS ARE IN MILLIMETERS (ANGLES IN DEGREES).

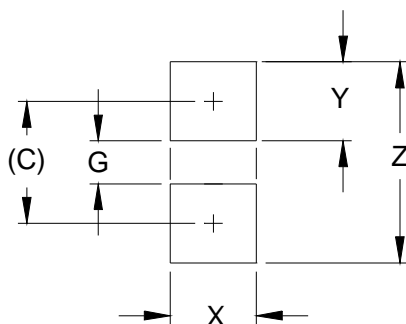
**Land Pattern - SLP1006P2**

DIM	DIMENSIONS	
	INCHES	MILLIMETERS
C	(.033)	(0.85)
G	.012	0.30
X	.024	0.60
Y	.022	0.55
Z	.055	1.40

**NOTES:**

1. CONTROLLING DIMENSIONS ARE IN MILLIMETERS (ANGLES IN DEGREES).
2. THIS LAND PATTERN IS FOR REFERENCE PURPOSES ONLY.  
CONSULT YOUR MANUFACTURING GROUP TO ENSURE YOUR COMPANY'S MANUFACTURING GUIDELINES ARE MET.

## PROTECTION PRODUCTS

### Marking Codes

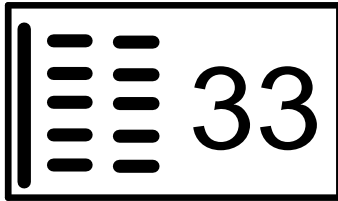

### Ordering Information

Part Number	Qty per Reel	Reel Size
RClamp3521P.TNT	10,000	7 Inch

Notes:

RailClamp and RClamp are trademarks of Semtech Corporation

Notes:

- 1) Device is electrically symmetrical
- 2) Marking will also include line matrix date code

### Carrier Tape Specification

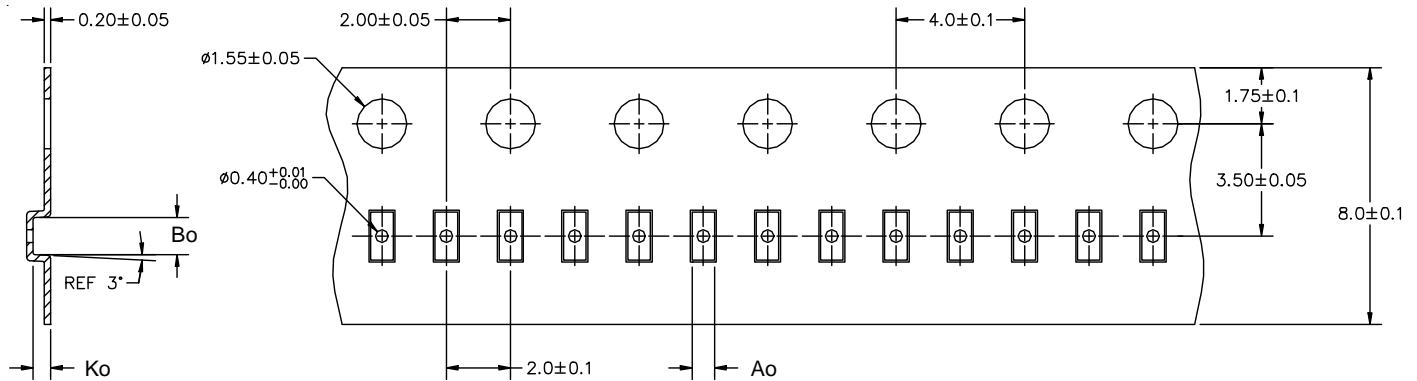

A0	B0	K0
0.69 +/-0.10 mm	1.19 +/-0.10 mm	0.66 +/-0.10 mm

Note: All dimensions in mm unless otherwise specified

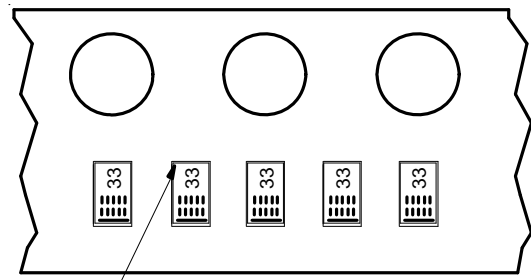

Pin 1 Location  
(Towards Sprocket Holes)

**Device Orientation in Tape**

**Contact Information**

Semtech Corporation  
Protection Products Division  
200 Flynn Road, Camarillo, CA 93012  
Phone: (805)498-2111 FAX (805)498-3804