

# EVALUATING THE AD9680 ANALOG-TO-DIGITAL CONVERTER

## Preface

This user guide describes the [AD9680](#) evaluation board [AD9680-1000EBZ](#) which provides all of the support circuitry required to operate the ADC in its various modes and configurations. The application software used to interface with the devices is also described.

The [AD9680](#) data sheet provides additional information and should be consulted when using the evaluation board. All documents and software tools are available at [www.analog.com/hsadcevalboard](http://www.analog.com/hsadcevalboard). For additional information or questions, send an email to [highspeed.converters@analog.com](mailto:highspeed.converters@analog.com).

## AD9680-1000EBZ

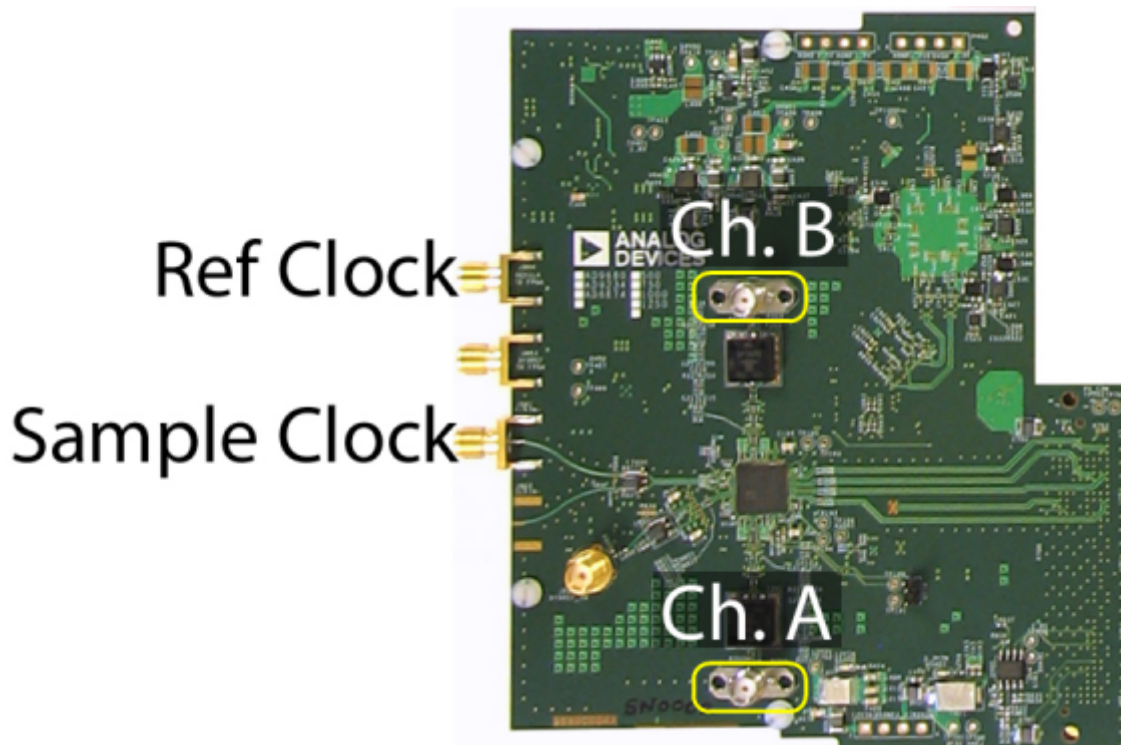

Figure 1. [AD9680-1000EBZ](#) Evaluation Board

## Typical Measurement Setup

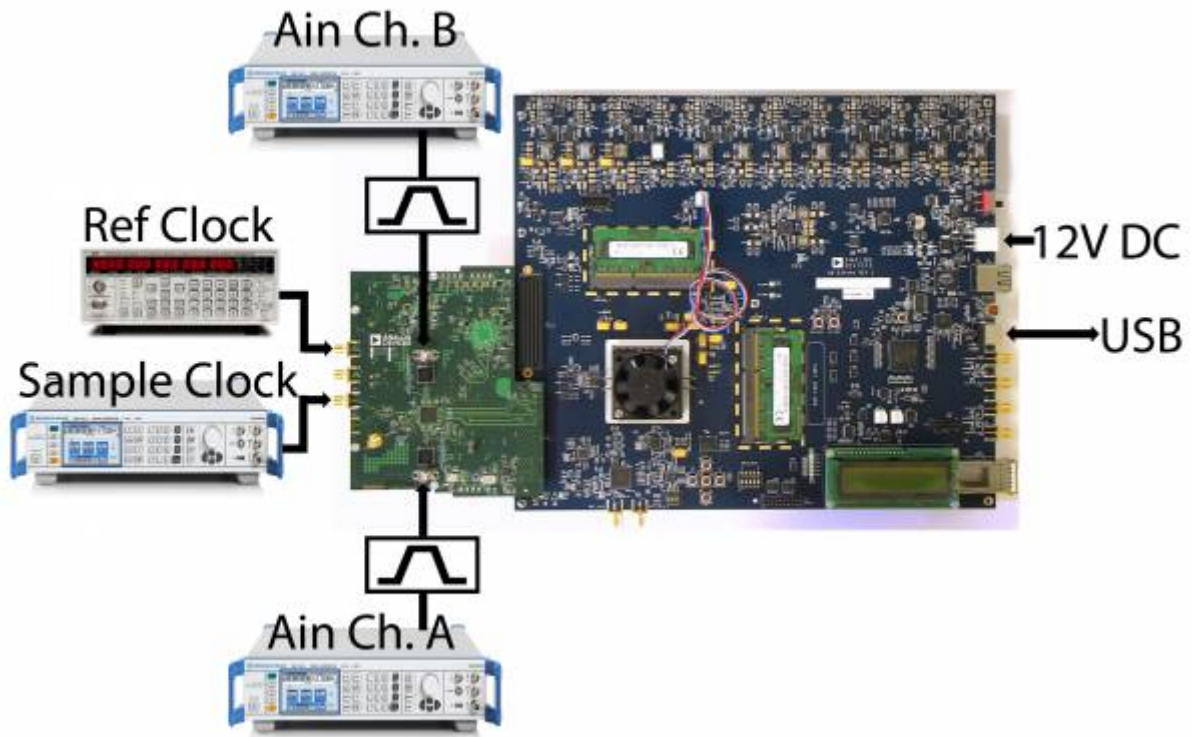

Figure 2. Evaluation Board Connection—[AD9680-1000EBZ](#) (on Left) and [ADS7-V1EBZ](#) (on Right)

## Features

- Full featured evaluation board for the [AD9680](#)
- SPI interface for setup and control
- Wide band Balun driven input
- No external supply needed. Uses 12V-1A and 3.3V-3A supplies from FMC
- VisualAnalog® and SPI controller software interfaces

## Helpful Documents

- [AD9680](#) Data Sheet
- [ADS7-V1EBZ](#) evaluation kit ([ADS7-V1EBZ](#))
- [AN-905 Application Note](#), *VisualAnalog Converter Evaluation Tool Version 1.0 User Manual*
- [AN-878 Application Note](#), *High Speed ADC SPI Control Software*
- [ADI SPI Application Note](#) *ADI Serial Control Interface Standard*

- 
- [AN-835 Application Note](#), *Understanding ADC Testing and Evaluation*

## Software Needed

- VisualAnalog [ftp://ftp.analog.com/pub/HSSP\\_SW/VisualAnalog/VisualAnalog\\_Setup.exe](ftp://ftp.analog.com/pub/HSSP_SW/VisualAnalog/VisualAnalog_Setup.exe)
- SPIController [ftp://ftp.analog.com/pub/adispi/A2DComponents/Install/SPIController\\_Setup.exe](ftp://ftp.analog.com/pub/adispi/A2DComponents/Install/SPIController_Setup.exe)

## Design and Integration Files

- [ftp://ftp.analog.com/pub/HSC\\_ADC\\_Apps/AD9680CE04B\\_Design\\_Support/](ftp://ftp.analog.com/pub/HSC_ADC_Apps/AD9680CE04B_Design_Support/)
- FPGA BIN file  
[ftp://ftp.analog.com/pub/HSC\\_ADC\\_Apps/ADs7-V1\\_packet/Firmware/ad9680\\_ads7v1\\_09242013\\_0949am.bin](ftp://ftp.analog.com/pub/HSC_ADC_Apps/ADs7-V1_packet/Firmware/ad9680_ads7v1_09242013_0949am.bin)

## Equipment Needed

- Analog signal source and antialiasing filter
- Sample clock source
- 12V, 6.5A switching power supply (such as the SL POWER CENB1080A1251F01 supplied with [ADS7-V1EBZ](#))
- PC running Windows®
- USB 2.0 port
- [AD9680-1000EBZ](#) board
- [ADS7-V1EBZ](#) FPGA-based data capture kit

## Getting Started

This section provides quick start procedures for using the [AD9680-1000EBZ](#) board.

### Configuring the Board

Before using the software for testing, configure the evaluation board as follows:

1. Connect the [AD9680-1000EBZ](#) evaluation board to the [ADS7-V1EBZ](#) data capture board, as shown in Figure 2.
2. Connect one 12V, 6.5A switching power supply (such as the CENB1080A1251F01 supplied) to P4 on the [ADS7-V1EBZ](#) board. Connect the Standard-B USB port of the [ADS7-V1EBZ](#) board to the PC with

the supplied USB cable.

3. Turn on the [ADS7-V1EBZ](#).
4. The [ADS7-V1EBZ](#) will appear in the Device Manager as shown in Figure 3.

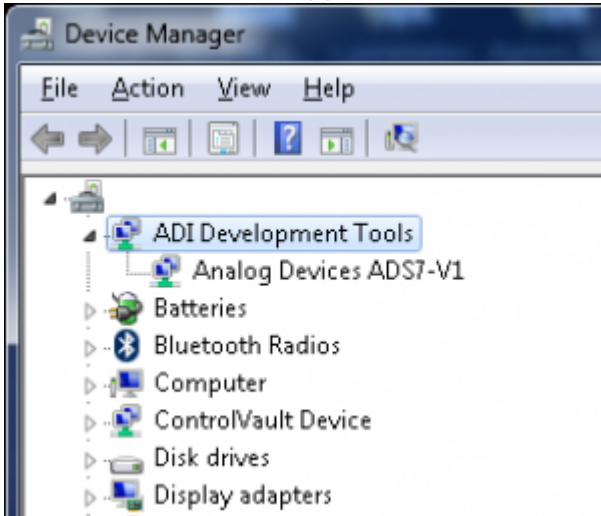

Figure 3. Device Manager showing [ADS7-V1EBZ](#)

5. If the Device Manager does not show the [ADS7-V1EBZ](#) listed as shown in Figure 2, unplug all USB devices from the PC, uninstall and re-install SPIController and VisualAnalog and restart the hardware setup from step 1.
6. On the ADC evaluation board, provide a clean, low jitter 1GHz clock source to connector J801 and set the amplitude to 14dBm. This is the ADC Sample Clock.
7. On the ADC evaluation board, provide a clean, low jitter clock source to connector J804 and set the amplitude to 10dBm. This is the Reference Clock for the gigabit transceivers in the FPGA. The REFCLK frequency can be calculated using the following empirical formulae:

$$\text{LaneLineRate} = \frac{M \times N_{\text{prime}} \times \left(\frac{10}{8}\right) \times f_{\text{out}}}{L} \text{ bps/lane, where}$$

$$f_{\text{out}} = \frac{f_{\text{ADC SAMPLE CLOCK}}}{\text{DecimationRatio}}, N_{\text{prime}} = 8 \text{ or } 16 \text{ (Default } N_{\text{prime}} = 16) \text{ REFCLK} = \frac{\text{LaneLineRate}}{20}$$

8. On the ADC evaluation board, use a clean signal generator with low phase noise to provide an input signal for channel A to P200. Use a shielded, RG-58, 50 Ω coaxial cable to connect the signal generator output to the ADC Evaluation Board. For best results, use a narrow-band, band-pass filter with 50 Ω terminations and an appropriate center frequency. (ADI uses TTE, Allen Avionics, and K & L band-pass filters.)
9. On the ADC evaluation board, use a clean signal generator with low phase noise to provide an input signal for channel B to P202. Use a shielded, RG-58, 50 Ω coaxial cable to connect the signal generator output to the ADC Evaluation Board. For best results, use a narrow-band, band-pass filter with 50 Ω terminations and an appropriate center frequency. (ADI uses TTE, Allen Avionics, and K & L band-pass filters.)

## Visual Analog Setup

1. Click Start → All Programs → Analog Devices → VisualAnalog → VisualAnalog
2. On the VisualAnalog "New Canvas" window, click **ADC** → **Dual** → **AD9680**

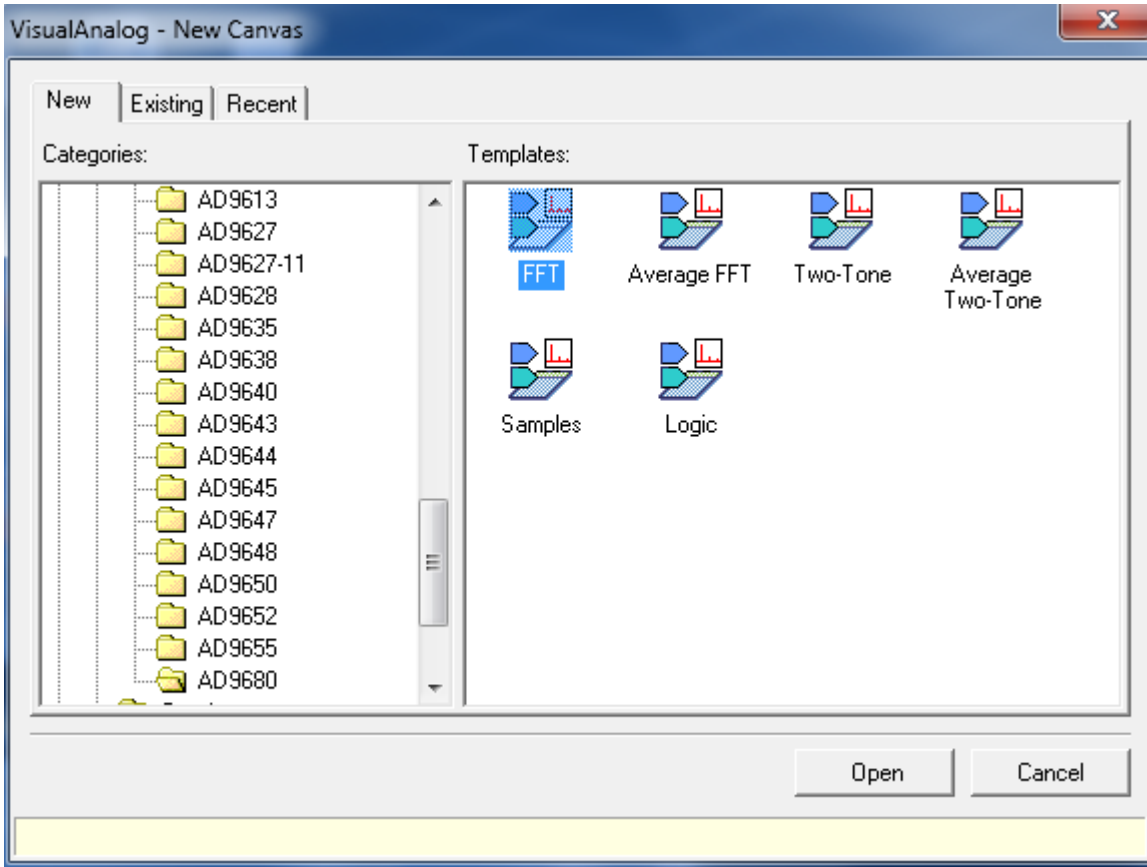

Figure 4.

Selecting the **AD9680** canvas

3. If VisualAnalog opens with a collapsed view, click on the “Expand Display” icon (see figure 5)

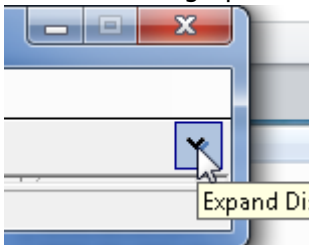

Figure 5. Expanding Display in VA

4. Click the **Settings** button in the **ADC Data Capture** block as shown in Figure 6

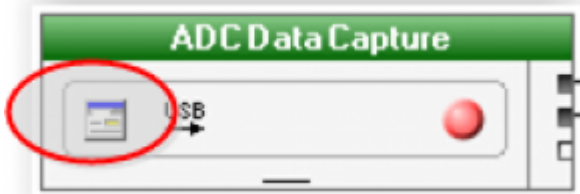

Figure 6. Changing the ADC Capture Settings

5. On the **General** tab make sure the clock frequency is set to **1000MHz** (or other clock frequency). The FFT capture length may be changed to 131072 (128k) or 262144 (256k) per channel. The ADs7-V1 FPGA software supports up to 2M FFT capture (1M per channel)

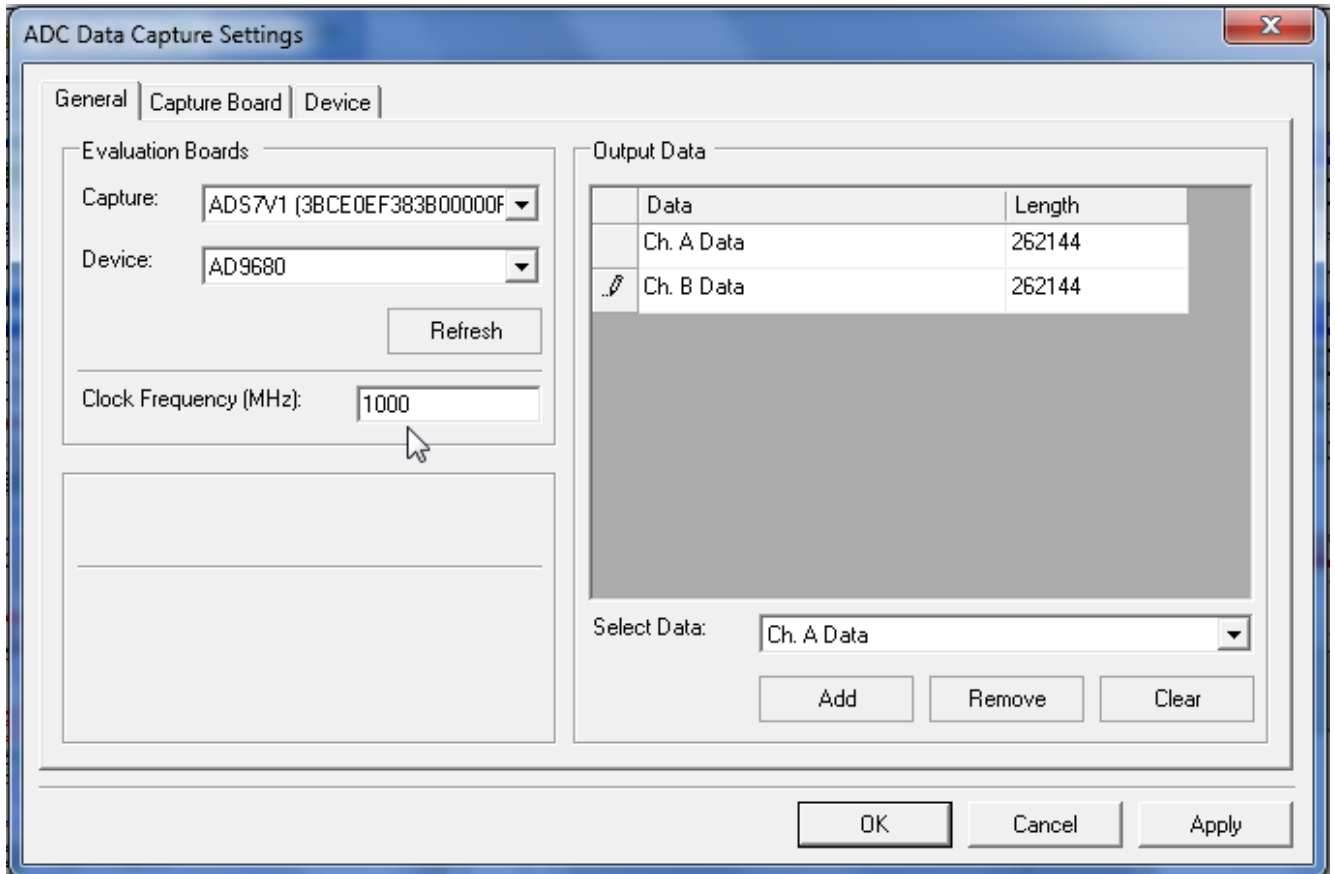

Figure 7. Setting the clock frequency and Capture length

6. Click on the **Capture Board** tab and browse to the **ad9680\_ads7v1\_09242013\_0949am.bin** file. Click the **Program** button. The **FPGA\_DONE** LED should illuminate on the ADS7-V1 board indicating that the FPGA has been correctly programmed. The bin file is available at the ftp site [ftp://ftp.analog.com/pub/HSC\\_ADC\\_Apps/ADs7-V1\\_packet/Firmware/ad9680\\_ads7v1\\_09242013\\_0949am.bin](ftp://ftp.analog.com/pub/HSC_ADC_Apps/ADs7-V1_packet/Firmware/ad9680_ads7v1_09242013_0949am.bin)
7. On the **Device** tab. Make sure that **Enable Alternate REFCLK** option is unchecked.
8. Click **OK**

## SPIController Setup

1. Click Start → All Programs → Analog Devices → SPIController → SPIController
2. Select the **AD9680\_14Bit\_1.25GSspiR03.cfg** if prompted.
3. In the **Global** tab, under the **Generic Read/Write** section, write 0x81 to register 0x000. This issues a Soft reset for the DUT.

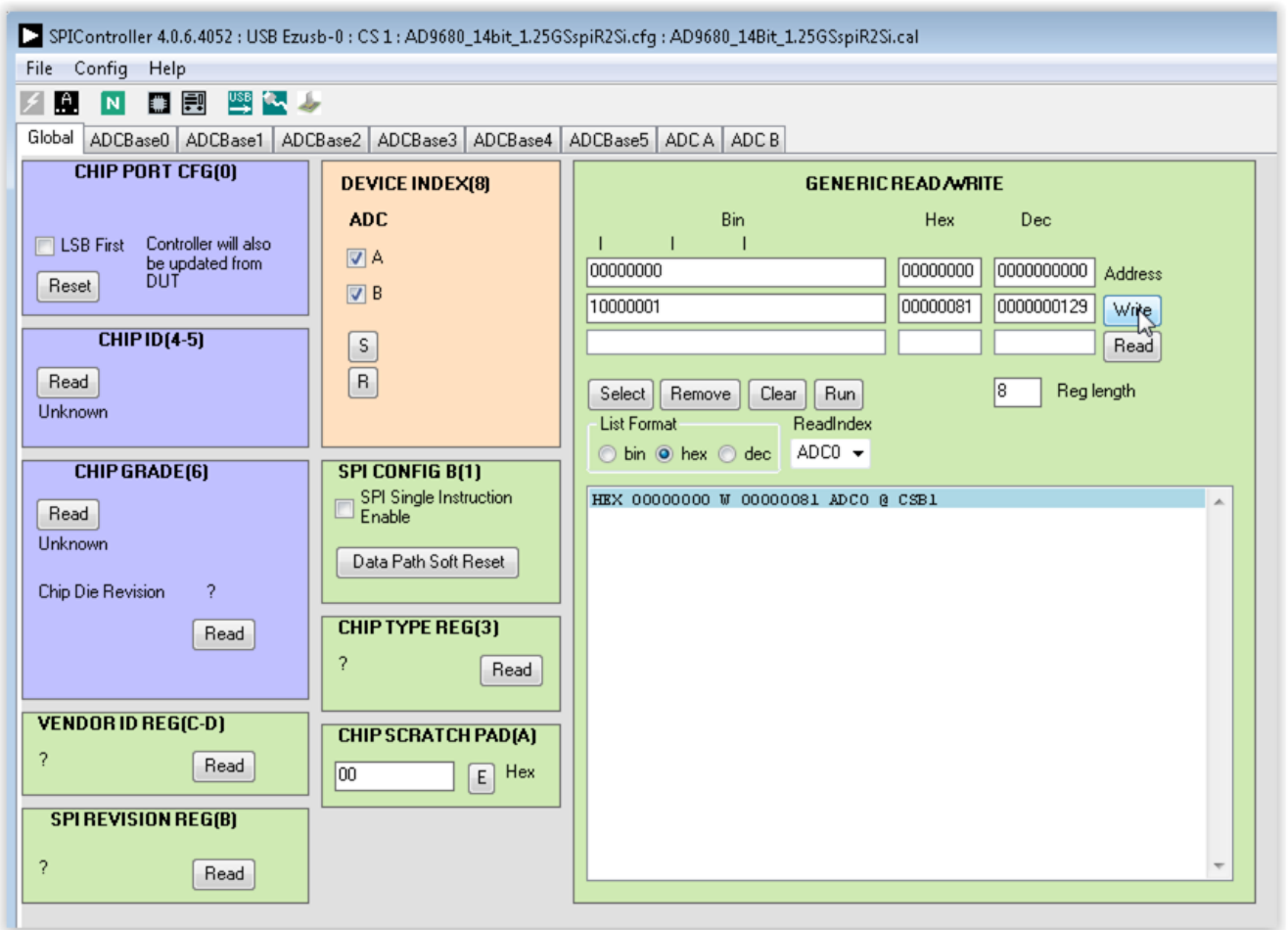

Figure 8. Sending a Soft Reset to the AD9680

- The JESD204B quick configuration and Lane Rate registers are available in the **ADCBase3** tab. Set the Lane Rate setting register 0x56E to **Maximum Lane Rate**

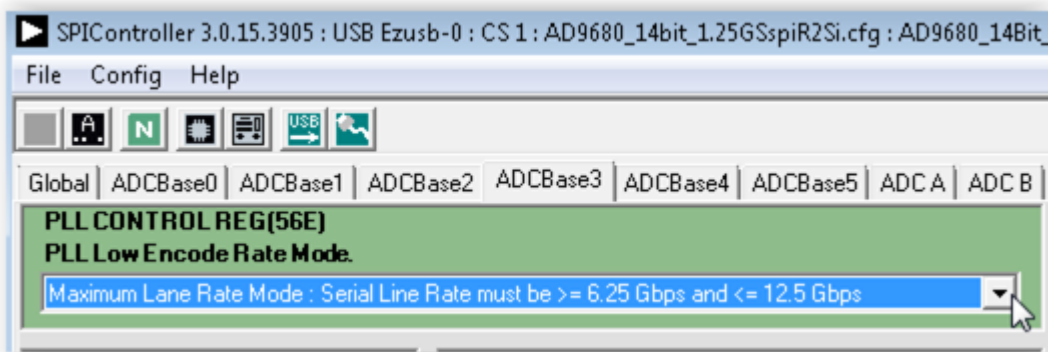

Figure 9. Setting the JESD204B Lane Rate

- Set the JESD204B Quick Configuration register 0x570. For 1000MSPS operation with no DDCs, the values for **L.M.F** are **4.2.1**

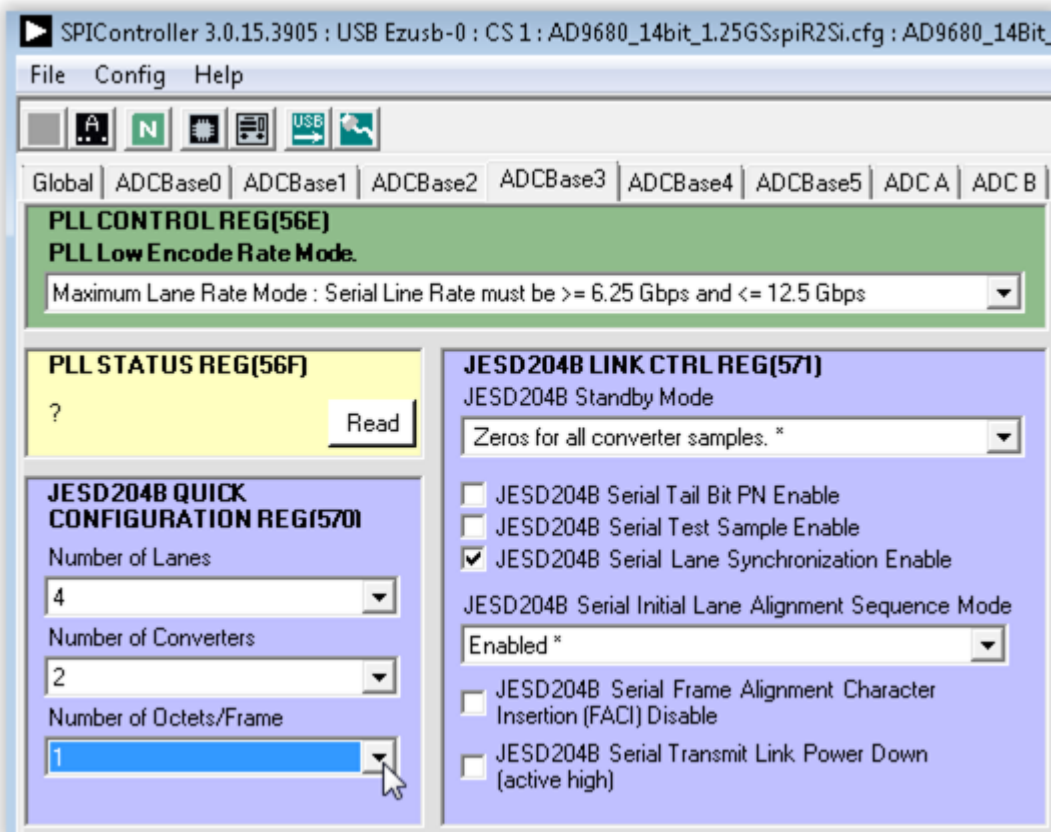
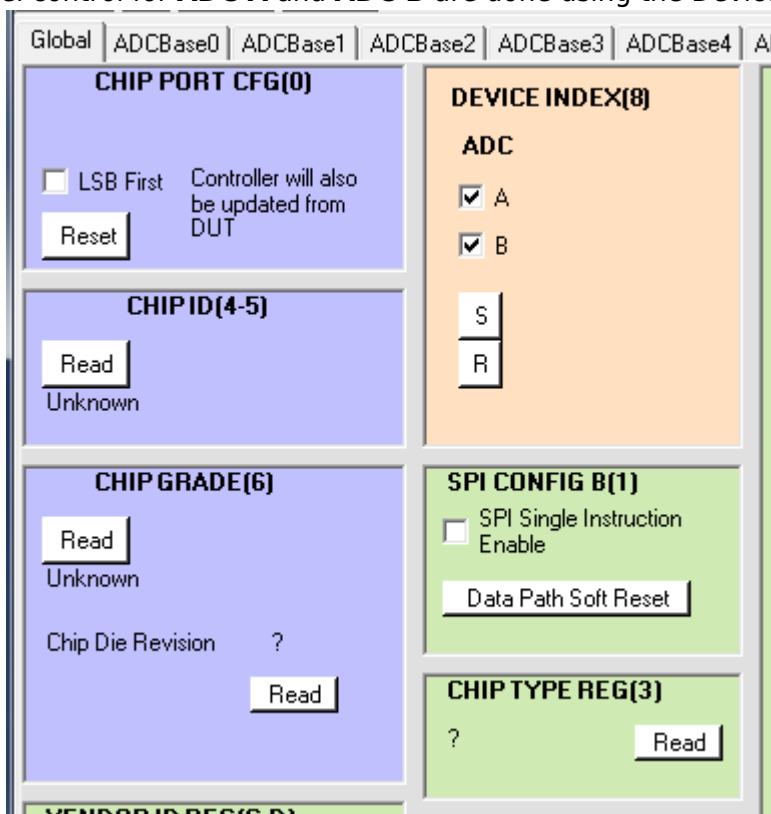

Figure 10. Setting the JESD204B Quick Configuration Register

- After the quick configuration setting is completed, the PLL Lock Detect register 0x56F will read 0x80 to denote a lock. The SPIController interface will show a "1" to denote a lock.
- Toggle the JESD204B link by checking and then unchecking the **JESD204B Serial Transmit Power Down** box
- Individual Channel control for **ADC A** and **ADC B** are done using the Device Index Register (0x008)



in the Global tab.

Figure 11. Device Index



for ADC Channel A and Channel B

9. Under **ADC A** and **ADC B** tabs the options for Channel A and B are listed. Default settings have been programmed to ensure optimal performance for the input bandwidth and sample rate. Only the following options need to be operated with:
  1. Chip Configuration Register (2): This option allows the channel to be powered on
  2. Buffer Current Setting (18): This option allows the buffer current to change to enable better harmonic performance at different frequencies. At high analog input frequencies, the buffer current may need to be increased to optimize harmonic distortion performance (HD2, HD3). Keep in mind that at high frequencies, the performance is also jitter limited. So increasing the buffer currents may lead to diminishing returns with higher power consumption. Refer to the datasheet to understand the relationship between  $I_{AVDD3}$  and Buffer Current Setting.
  3. Analog Input Differential Termination (16): This sets the input termination. Recommended settings are 500, 200, 100, 50 ohms. At lower termination settings, the harmonic distortion performance may show improvement, but the analog input signal amplitude will be reduced.
  4. Input Full Scale Range (25): At high input frequencies, in order to preserve the linearity of the input buffer, it may be beneficial to reduce the input full-scale range in order to get more harmonic distortion performance. This in turn may negatively affect the SNR of the ADC.

## Obtaining an FFT

1. Click the Run button in VisualAnalog , you should see the captured data similar to the plot shown in Figure 12.

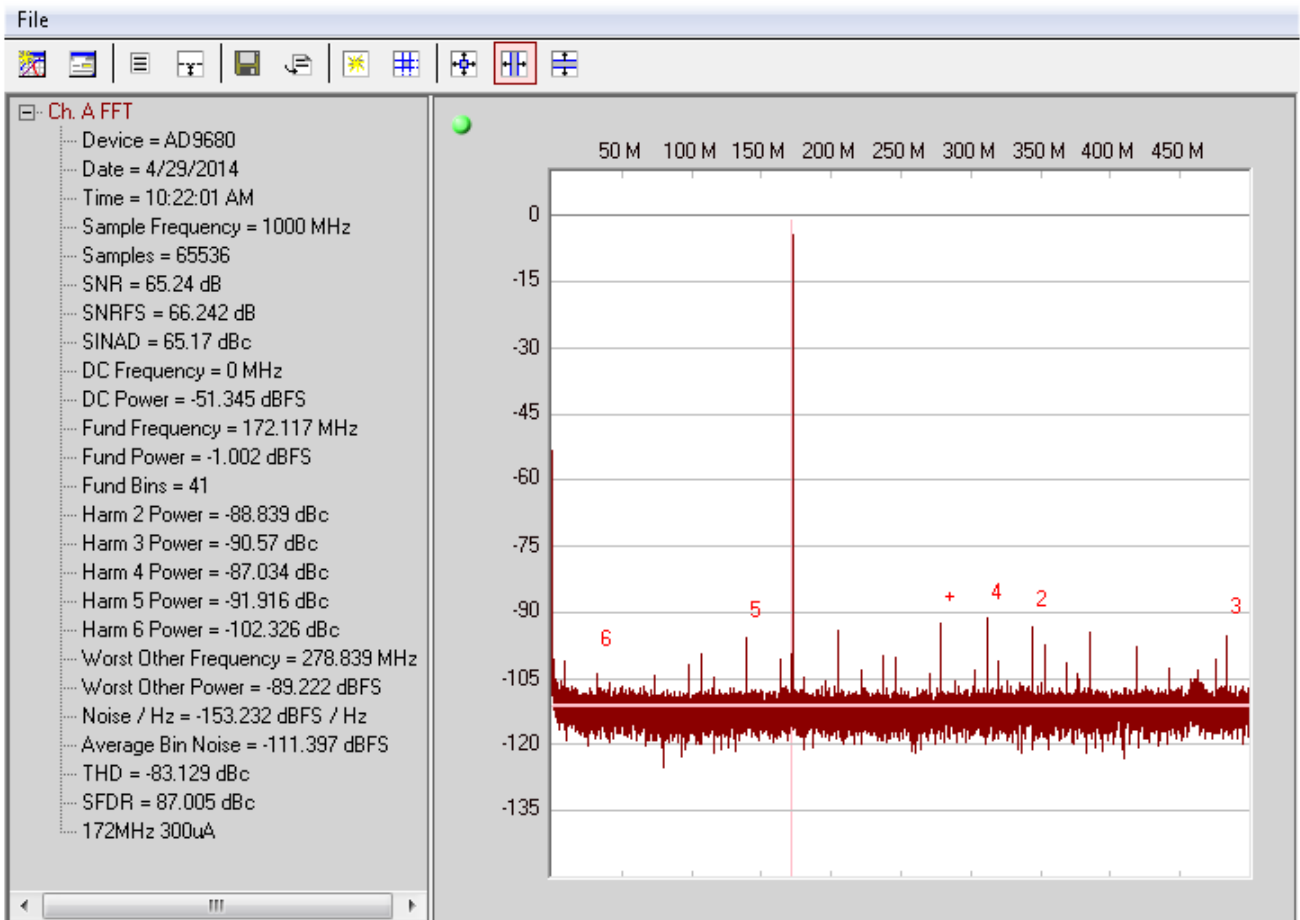

Figure 12. AD9680-1000 FFT at 170MHz Analog Input

2. Adjust the amplitude of the input signal so that the fundamental is at the desired level. (Examine the **Fund Power** reading in the left panel of the VisualAnalog FFT window.)
3. To save the FFT plot do the following

1.

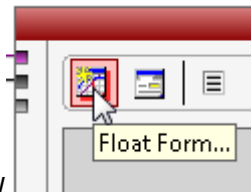

Figure 13. Floating the FFT window

Click on the Float Form button in the FFT window

2. Click on File → Save Form As button and save it to a location of choice

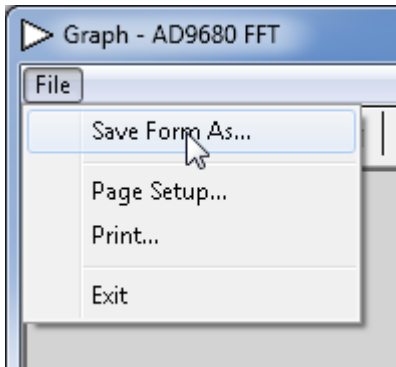

Figure 14. Saving the FFT

# Troubleshooting Tips

## FFT plot appears abnormal

- If you see a normal noise floor when you disconnect the signal generator from the analog input, be sure you are not overdriving the ADC. Reduce input level if necessary.
- In VisualAnalog, Click on the Settings button in the **Input Formatter** block. Check that **Number Format** is set to the correct encoding (twos complement by default). Repeat for the other channel.
- Issue a **Data Path Soft Reset** through SPIController **Global** tab as shown in Figure 15

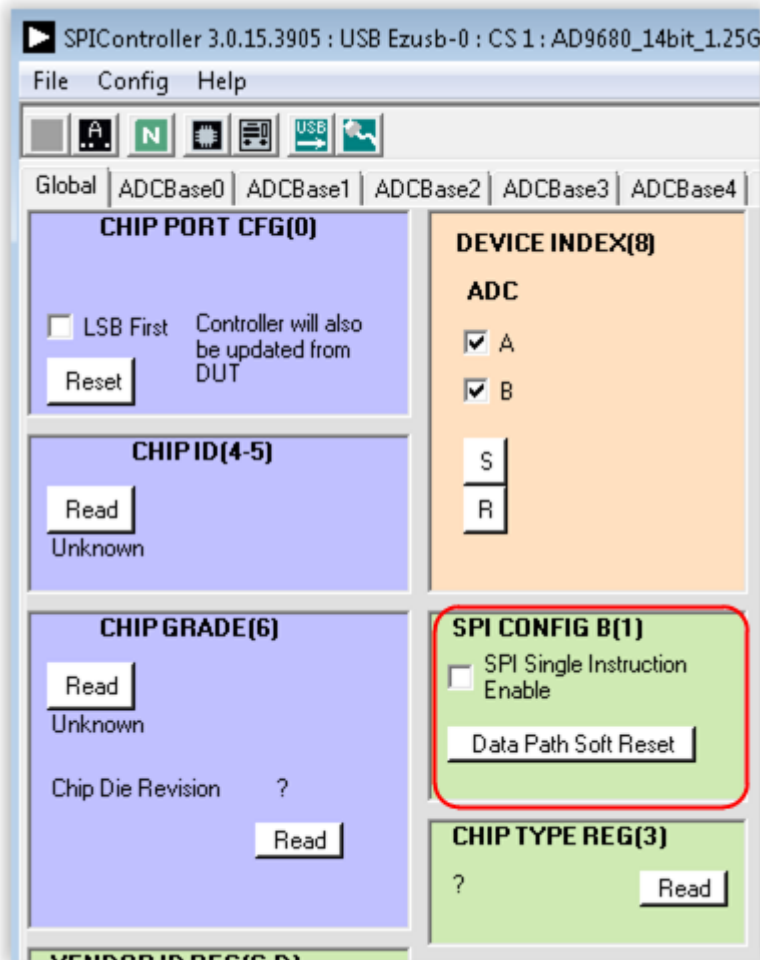

Figure 15. Issuing a data path soft reset

through SPIController

## The FFT plot appears normal, but performance is poor.

- Make sure you are using the appropriate band-pass filter on the analog input.
- Make sure the signal generators for the clock and the analog input are clean (low phase noise).
- If you are using non-coherent sampling, change the analog input frequency slightly, or use coherent frequencies.
- Make sure the SPI config file matches the product being evaluated.

## The FFT window remains blank after the Run button is clicked

- Make sure the evaluation board is securely connected to the ADS7-V1.
- Make sure the FPGA has been programmed by verifying that the **Config DONE** LED is illuminated

on the ADS7-V1. If this LED is not illuminated reprogram the FPGA through VisualAnalog. If the LED still does not illuminate disconnect the USB and power cord for 15 seconds. Connect again and repeat the ADS7-V1 setup process.

- Make sure the correct FPGA *bin* file was used to program the FPGA.
- Be sure that the correct sample rate is programmed. Click on the **Settings** button in the **ADC Data Capture** block in VisualAnalog, and verify that the **Clock Frequency** is properly set.

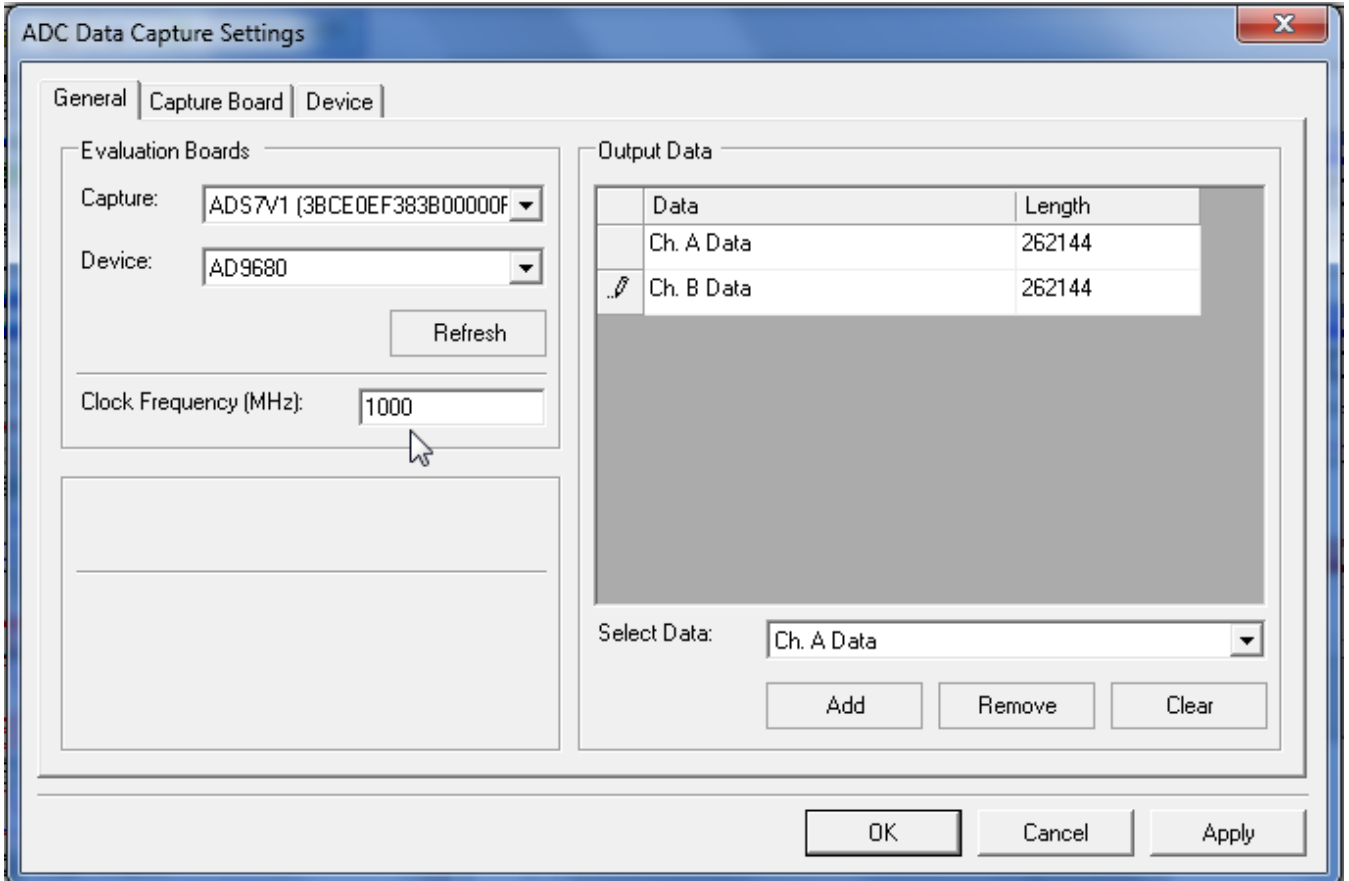

Figure 16. Setting the correct clock frequency in VisualAnalog

- Ensure that the REFCLOCK is ON and set to the appropriate frequency.
- Restart SPIController.

**VisualAnalog indicates that the “FIFO capture timed out” or “FIFO not ready for read back”**

- Make sure all power and USB connections are secure.
- Make sure that the REFCLOCK is ON and set to the appropriate frequency.

**VisualAnalog displays a blank FFT when the RUN button is clicked**

- Ensure that the clock to the ADC is supplied. Using SPIController **ADCBase0** tab the status of the clock can be read out. See figure 17.

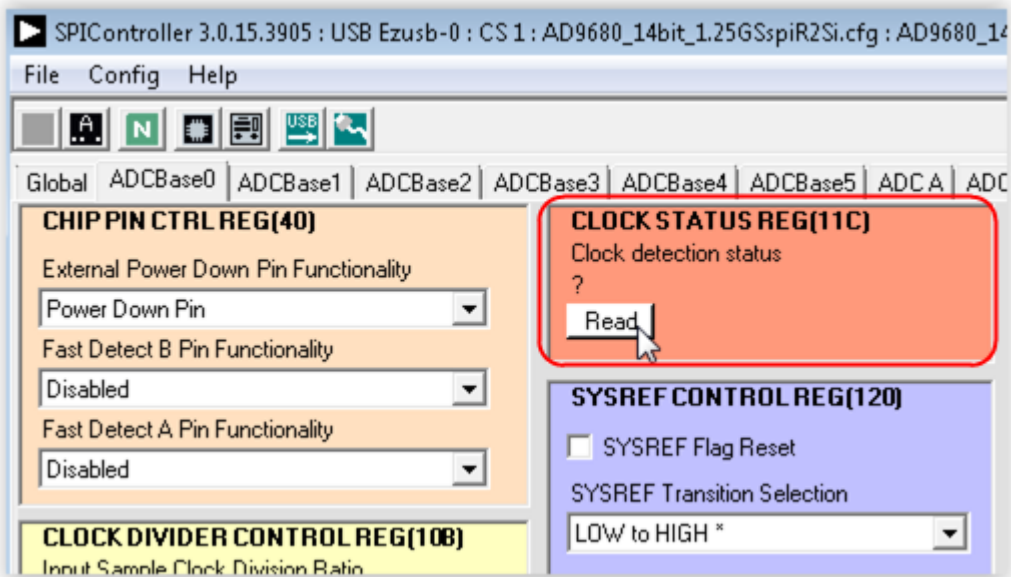

Figure 17. Clock

*Detection Status Register*

- Ensure that the ADC's PLL is locked by checking the status of the PLL lock detect register 0x56F. This can be done using SPIController.

© Analog Devices, Inc. All rights reserved. Trademarks and registered trademarks are the property of their respective owners.



[www.analog.com](http://www.analog.com)