

1 2 3 4 5 6

A

B

C

D

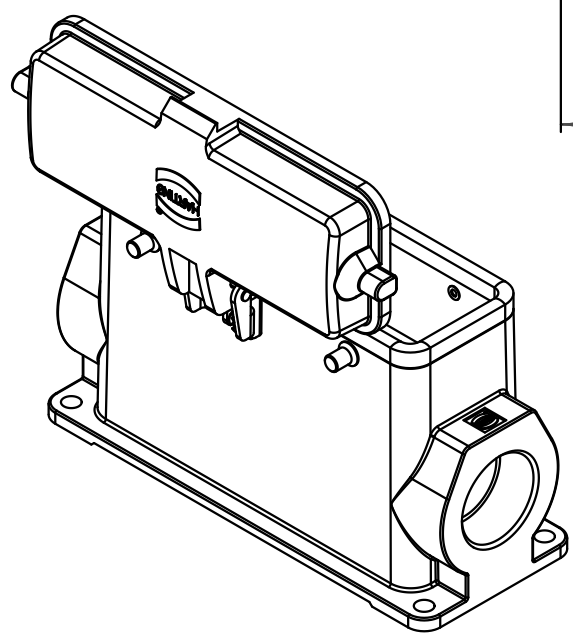
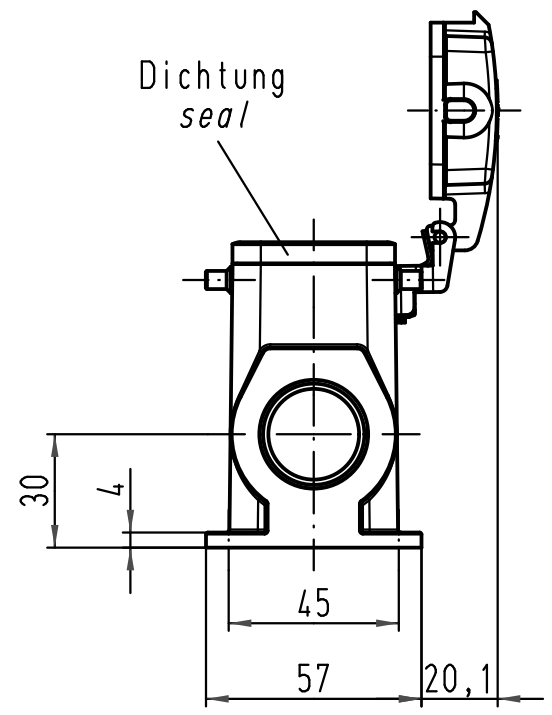
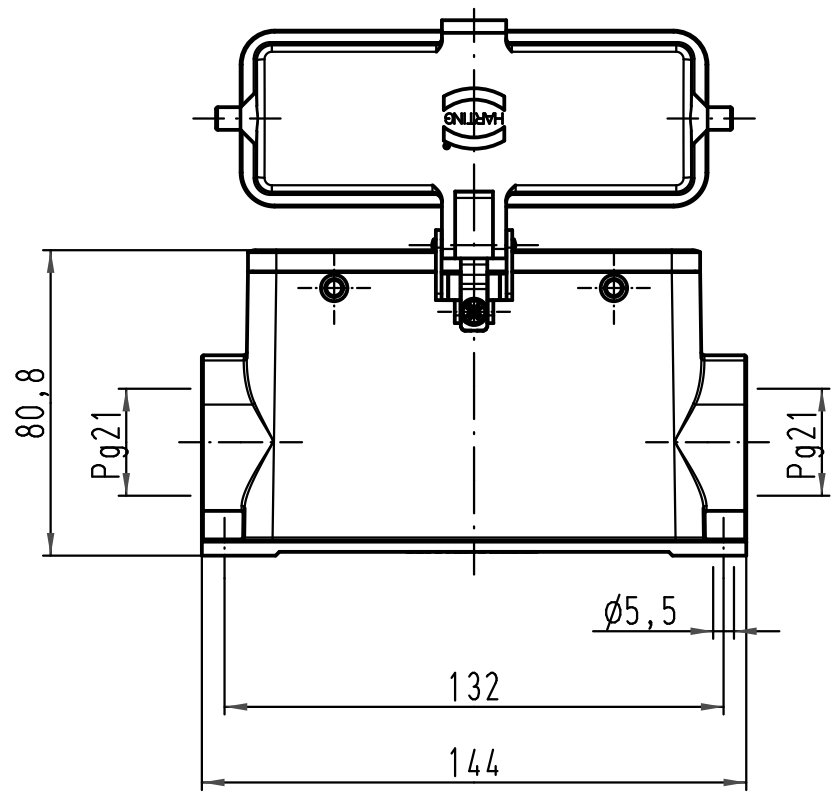

All Dimensions in mm Original Size DIN A 4		Techn. Character.			Nicht tolerierte Maß/Free size tolerances	
			Dat.	Name	Maßstab/Scale 1:2	Han 24B-asg2-K-21 Sockelgehäuse housing surface mounting
			Detail.	04.03.11 Spr		
			Insp.	Be		
			Stand.			
A			HARTING Electric GmbH & Co. KG D-32339 Espelkamp			TB 09 30 024 0260
Mod.	Dat.	Name				
						Blatt/page