

## IRAC1152-350W

Reference Design Kit for IR1152 (Fixed 66kHz Frequency,  
 One Cycle Control PFC IC with Brown-Out Protection)

### REFERENCE DESIGN KIT FEATURES

- IEC61000-3-2 Class D Standards Compliant
- Less than 10% Total Harmonic Distortion (115-230VAC/350W)
- Universal AC Input Voltage capability
- Fully regulated 388V DC bus
- Full load start-up, no minimum load requirements
- Current loop controlled soft-current limit protection for overpower limitation at minimum VAC
- High Efficiency Si Superjunction MOSFET boost switch
- Hyper-fast recovery Si boost diode
- On-board Flyback SMPS for 15V VCC supply (option to disable for external VCC bias supply)
- Single layer PCB illustrating layout best-practices

### IR1152 PFC IC FEATURES

- PFC IC with IR proprietary “One Cycle Control”
- Continuous conduction mode boost type PFC
- Fixed 66kHz switching frequency
- Average current mode control
- Input line sensed brownout protection
- DC bus overvoltage protection (Dual & Dedicated)
- DC bus open feedback loop protection
- Cycle-by-cycle peak current limit (DC bus voltage foldback type)
- Soft-current limit protection
- VCC under voltage lockout
- Programmable soft-start
- Micropower startup & sleep mode (user-initiated)
- 750mA peak gate drive
- Optimized pin-out for single layer PCB layout

### Product Summary

AC Input Voltage	85-264VAC
AC Input Line Frequency	47-63Hz
DC Bus Output Voltage	388V +/- 2%
Maximum output power	350W
Minimum Load Requirement	None
Power Factor (115-230VAC/350W)	>0.98
Total Harmonic Distortion (115-230VAC/350W)	<10%
Start-up time	60ms

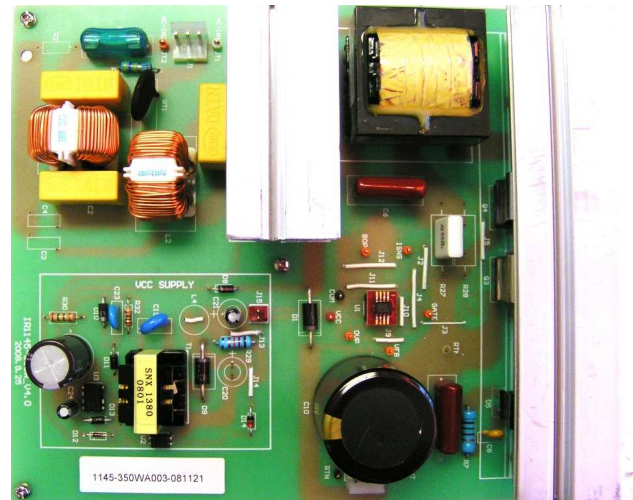

## Introduction

IRAC1152-350W is a full function AC-DC reference design showcasing the operation of IR1152 PFC IC in a continuous conduction mode boost converter for achieving power factor correction, sub-10% harmonic current distortion and EN61000-3-2 Class D harmonic current limits standard compliance. Designed to be operated from 85-264VAC universal input voltage, IRAC1152-350W delivers 350W continuous output power via a fully regulated 388V DC bus. Thanks to IR1152 PFC IC, the reference design is rendered with a very high level of safety against system abnormalities such as AC line sag, DC bus voltage loop feedback loss, system overcurrent & overvoltage. Combining the cost-advantage of single layer PCB and ferrite-core boost inductors with optimized PCB layout, the IRAC1152-350W reference design is an excellent design example that can be seamlessly imported & integrated by system designers that require a high-performance PFC stage at the AC-DC front-end of their designs in a variety of applications.

**Table of Contents**

Introduction .....1  
 Description of Hardware & Key Operating Features .....4  
 Hardware Installation & Operating Procedure .....7  
 Performance Characterization .....9  
 IRAC1152-350W Schematics .....19  
 IRAC1152-350W Bill of Materials (BoM) .....22  
 IRAC1152-350W PCB & Component Layout .....24

**List of Figures**

Figure 1 IRAC1152-350W test set-up.....7  
 Figure 2: IRAC1152-350W external Vcc connection .....8  
 Figure 3. Power factor vs. Line/Load Variation of IRAC1152-350W .....9  
 Figure 4. Current Harmonics at 85-264VAC, 350W .....10  
 Figure 5. Current Harmonics at 85-264VAC, 87.5W (25% of rated power).....10  
 Figure 6. THD at 350W across 85-264VAC for IRAC1152-350W .....11  
 Figure 7. EMI filter stage causes phase-shift in Input Current Waveform (264VAC, 350W).....13  
 Figure 8. Power factor vs. Line/Load for modified IRAC1152-350W with single stage EMI filter .....13  
 Figure 9. 2X AC frequency ripple in DC bus capacitor at 85VAC, 350W .....14  
 Figure 10. 2X AC frequency ripple in DC bus capacitor at 264VAC, 350W .....14

## Safety Precautions

---



**ATTENTION:** The ground potential of the IRAC1152-350W is biased to a negative DC bus voltage potential. In order to be able to safely measure voltage waveform by oscilloscope, the use of an isolation transformer at the AC input is recommended. Though floating the ground potential of the scope is often practiced, it is not recommended. Failure to follow these guidelines so may result in personal injury or death.

---



**ATTENTION:** The IRAC1152-350W system contains dc bus capacitors & capacitors on the rectified AC line (C6, C9, C10, C21, C22), which take time to discharge after removal of main supply. Remove and lock out power from the IRAC1152-350W board before you attempt to disconnect or reconnect wires or perform service. Wait at least one minute after removing power to discharge the capacitor voltages. Do not attempt to service the reference design until all capacitor voltages have discharged to zero. Failure to do so may result in bodily injury or death.

---



**ATTENTION:** Only personnel familiar with the IRAC1152-350W system should plan or implement the installation, start-up, and subsequent maintenance of the system. Failure to comply may result in personal injury and/or equipment damage.

---



**ATTENTION:** The surface temperatures of the IRAC1152-350W board & heatsink may become hot, which may cause injury. A fan is recommended to cool the board whenever operating at the full rated power for prolonged periods.

---



**ATTENTION:** The IRAC1152-350W system contains ESD (Electrostatic Discharge) sensitive parts and assemblies. Static control precautions are required when installing, testing, servicing or repairing this assembly. Component damage may result if ESD control procedures are not followed. If you are not familiar with static control procedures, reference applicable ESD protection handbook and guideline.

---



**ATTENTION:** An incorrectly applied or installed board can result in component damage or reduction in product life. Wiring errors, supplying an incorrect AC supply, or excessive ambient temperatures may result in system malfunction.

---



**ATTENTION:** IRAC1152-350W system is shipped with packing materials that need to be removed prior to installation. Failure to remove all debris and packing materials which are unnecessary for system installation may result in abnormal operating condition.

---

## Description of Hardware & Key Operating Features

The key features of the IRAC1152-350W hardware are listed below. The user is referred to IRAC1152-350W schematics provided later in the document for the following discussions and also to “350W PFC Converter Design Example” section in IR1152 Application Note AN-1150 where the design and component selection for IRAC1152-350W is explained in detail in.

### AC Input Stage (before bridge rectifier)

- EMI Stage is comprised of a 2 stage EMI filter composed of 3X 0.47uF X-capacitors & 2X common-mode EMI choke coils with 10mH (16kHz) rated magnetic impedance; There are no Y-capacitors installed, but they can be installed in sockets C3 & C4 if the user so desires.
- Inrush current limitation is provided by a NTC (negative thermal co-efficient) resistor offering 5ohm impedance at 25C
- A 250V, 6.3A fuse is included for current protection.

### Power Stage

- Bridge Rectifier: 600V, 8A bridge rectifier (B1) is employed.
- Boost Inductor: A 600uH, 6A Boost inductor (L1) based on PC40 ferrite magnetic core and EER-42/42/20 core size is employed. With 600uH of boost inductance, the ripple current factor is about 0.3 (30% current ripple) near peak of AC sinusoid at 85VAC, 350W (DC bus voltage=388V). The user can substitute this with another inductor in order to adjust the ripple current factor.
- Boost Switch & Gate Drive Circuit: 2X 600V, 20A superjunction MOSFETs (Q3 & Q4) connected in parallel are employed for boost switch function. The gate drive for MOSFETs is provided by a NPN-PNP buffer circuit in order to render a tight gate-drive switching loop. It is noted that, since NPN-PNP buffer is a base-follower circuit, the voltage clamp on GATE output of IR1152 IC is also closely maintained on the output of the NPN-PNP buffer circuit driving the MOSFETs. The user can also disable the NPN-PNP buffer circuit & drive the MOSFETs directly using IR1152 IC's output GATE driver by implementing the following steps:
  - i. Un-install jumper J4
  - ii. Uninstall surface mount resistors R18 & R19
  - iii. Install jumper J3
  - iv. Modify IR1152 GATE series resistor R16 (0 ohms in default configuration), if necessaryLocalized gate resistor & diode networks (R20, R22, D7 for Q3 & R5, R6, D4 for Q4) is used to preferentially adjust turn-on & turn-off dV/dt. Turn-on is slower to control reverse recovery behavior of boost diode. Finally a Schottky diode, D6 between GATE & COM pins of IR1152 is used to clamp any negative voltage spikes that can cause IC latch-up.
- Boost Diode: A 600V, 8A hyper-fast recovery diode (D5) is employed as boost diode with snubber circuit (R7, C8) to limit voltage spikes.
- DC Bus Capacitor: 330uF, 450V capacitor (C10) is employed on the DC bus for acceptable ripple at 350W power rating at 388VDC. A 1W, 470kohm bleed resistor (R10) is used across C10 to discharge the bus voltage.
- Current Sense Resistor: R27 & R28 are sockets allocated for current sense resistor. Dual footprints are provided for both sockets for flexibility. IRAC1152-350W employs a 50mohm, 5W current sense resistor in R27 socket (R28 is not populated). The choice of current sense resistor programs the following:
  - i. Current level at which cycle-by-cycle peak current protection limit is encountered. When this is encountered, IR1152 instantaneously pulls the GATE output low.

- ii. Current level (and hence power level) at which soft-current protection limit is invoked at a specific VAC voltage. When this is encountered, IR1152 limits the duty cycle of the PFC switch which causes DC bus voltage to foldback (or droop). This is how IR1152 provides overpower limitation. The power level at which this protection is encountered increases with increasing VAC. The current sense resistor employed in IRAC1152-350W is such that the reference design is guaranteed to deliver 350W at VAC=85VAC without DC bus voltage foldback. At VAC=85VAC, the DC bus voltage foldback occurs at about 430W output power in IRAC1152-350W.

<b>IRAC1152-350W Default Set-point</b>	<b>Typical Level</b>
Cycle-by-Cycle Peak Current Protection Limit	15A
Soft-current Protection Limit at 85VAC	9.8A

CAUTION: If the user attempts to modify the power level of the PCB by changing the current sense resistor, attention must be paid to the component ratings - semiconductors (bridge rectifier, boost switch, boost diode), boost inductor, fuse, DC bus capacitor – and system thermal performance (use a fan to cool heatsink, run at lower ambient temperature etc).

- Current Monitoring: Jumper J7 is provided for monitoring the inductor current and Jumper J8 is provided for monitoring the PFC switch current. Current loops (for use with a magnetic current probe) can be established by uninstalling the onboard jumper wires and installing a current loop of adequate length to fit the probe.

**On-board Flyback SMPS**

- An onboard DC-DC Flyback SMPS delivers 16VDC for biasing the VCC pin of IR1152 IC. The Flyback is configured to supply 16VDC when the VAC voltage is around 35-40VAC. If user desires to provide IR1152 VCC bias using an external DC supply in order to study the standby & start-up current requirements of IR1152, then onboard Flyback SMPS can be disconnected by implementing the following steps:
  - i. Un-install jumper J13
  - ii. Though not necessary, un-installing diode D8 is also recommended for safety reasons to fully disable the Flyback power supply
  - iii. Input connector J15 can be used for providing external DC supply to bias the VCC pin of IR1152; please pay attention to the connector biasing as shown in Figure 2. in the Installation and Operating Instructions section of this document

**IR1152 IC Control Circuit**

- VFB Pin – The DC bus voltage is programmed using the resistor divider comprised of R8, R23 & R24. By adjusting R24, the user can modify the DC bus voltage. Increasing R24 will decrease DC bus voltage. Decreasing R24 will increase DC bus voltage. By default, the overvoltage comparator on VFB pin programs the overvoltage protection set-point of IRAC1152-350W to 106% of DC Bus voltage and overvoltage protection reset set-point of IRAC1152-350W to 103% of DC Bus voltage.

<b>IRAC1152-350W Default Set-point</b>	<b>Typical Level</b>
DC Bus Regulation Voltage	388V
Overvoltage Protection Set-point (VFB pin)	411V
Overvoltage Protection Reset Set-point (VFB pin)	402V

- OVP Pin – OVP pin resistor divider (R9, R25 & R26) uses the same component values as VFB pin resistor divider. This programs the overvoltage protection set-point of comparator on OVP pin to be same as that of VFB pin. This is the recommended configuration & default for IRAC1152-350W. Thus, the function of OVP pin is two-fold:
  - i. dedicated pin to monitor DC bus voltage for overvoltage situations
  - ii. along with overvoltage comparator on VFB pin, the OVP pin provides dual overvoltage protection i.e. additional redundancy in system overvoltage protection in order to guarantee a very high level of safety

<b>IRAC1152-350W Default Set-point</b>	<b>Typical Level</b>
Overvoltage Protection Set-point (OVP pin)	411V
Overvoltage Protection Reset Set-point (OVP pin)	402V

CAUTION: The following cautionary statements apply if user attempts to modify value of R24 or R26 in IRAC1152-350W.

- If the modification causes  $R26 < R24$ , then overvoltage protection set-point & overvoltage protection reset set-point of OVP pin will be higher than that of VFB pin. This configuration is acceptable. However, it is noted that the overvoltage protection set-point & overvoltage protection reset set-point of IRAC1152-350W reference design as a whole is still determined by the set-points of VFB pin.
  - If the modification causes  $R26 > R24$ , then overvoltage protection set-point & overvoltage protection reset set-point of OVP pin will be lower than that of VFB pin. This configuration is generally NOT recommended because the modification may render overvoltage protection reset set-point of OVP pin to be less than DC bus voltage. This may cause DC bus voltage regulation issues & undesirable oscillations during system start-up & load transients.
- BOP Pin – Resistors R3, R4 & R12 and capacitor C14 constitute a divide-and-average circuit on the BOP pin. The choice of resistor divider components (R3, R4 & R12) determines VAC voltage at which IC exits Brown-out fault condition during system start-up. Decreasing R12 will cause IC to exit Brown-out fault condition at a higher VAC during start-up (and vice versa). The capacitor C14, which implements the averaging function, also programs amplitude of 2X AC frequency ripple voltage on BOP pin. As VAC is decreased, when the valley of VBOP ripple voltage encounters Brown-out protection threshold then a Brown-out fault condition is immediately triggered. Thus it is VBOP ripple voltage which determines at what VAC voltage a Brown-out fault condition is triggered during AC line sag. And by controlling VBOP ripple, the value of C14 determines VAC voltage at which Brown-out fault condition is triggered. If C14 is increased, VBOP ripple is reduced and Brown-out fault is triggered at a lower VAC (and vice versa). Diode D2 in BOP circuit is optional.

<b>IRAC1152-350W Default Set-point</b>	<b>Typical Level</b>
Brown-out Protection Trigger Threshold during AC line sag (350W)	55VAC
Brown-out Protection Enable Threshold during system start-up (0W)	65VAC

- VCOMP Pin – C12, C13 & R15 are involved in the following functions:
  - voltage loop compensation (location of pole & zero in voltage loop feedback response & phase margin)
  - C12 primarily determines the system soft-start time during start-up
 The user is recommended to review “Voltage Loop Compensation” section in AN-1150 before modifying any of these components, since such an explanation is outside the scope of this document.
- ISNS Pin –The VISNS signal from the current sense resistor is filtered using RC network created by R11 & C11 in order to provide a clean signal to the IR1152 IC.
- VCC Pin – A 22uF Tantalum surface-mount capacitor and a 1uF ceramic surface mount capacitor (located as close as possible to VCC & COM pins) are used to provide optimum decoupling for the VCC bias to IR1152 IC. An 18V zener diode, D3 is used to clamp overvoltage spikes on VCC pin & protect IR1152 IC.
- COM Pin – A STAR connection point located very close to the COM pin of the IC is used to individually terminate all the control signal return loops (VCC, VCOMP, VFB, OVP, BOP & power GND). Please refer to PCB Layout Features section of this document for more information.
- GATE Pin – Please refer to Boost Switch & Gate Drive Circuit section of this document for more information.

**PCB Layout Best Practices & Noise Suppression Features in IRAC1152-350W**

IRAC1152-350W is based on a single layer PCB & jumper connections for cost-reduction purpose. The PCB layout in IRAC1152-350W, especially control circuitry, is an excellent example that can be studied & reproduced by the user in his designs in order to achieve clean, noise-free operation in end application. The following points are noteworthy:

- **VCOMP-COM voltage loop:-** The VCOMP voltage is the most important control voltage for IR1152 operation. The trace connection from C12 & C13 components in VCOMP-COM control loop to COM pin must be done in an independent & isolated manner (i.e. it must be a dedicated trace and not share the ground return loop of any other control circuit such as VFB-COM, VCC-COM etc). This is very important to achieve a clean VCOMP signal
- **COM STAR connection & Dedicated ground return loops:-** A STAR connection point located very close to the COM pin of the IC is used to individually terminate all the control signal ground return loops (VCC-COM, VCOMP-COM, VFB-COM+OVP-COM, BOP-COM & VISNS-COM i.e. power GND & ground plane). Each control loop has its own dedicated ground trace which is not shared with ground return of other loops. This STAR connection ensures that the noise in one control signal loop does not proliferate into another control loop.
- **IR1152 pin-out & ground plane in single layer PCB:-** The pin-out arrangement in IR1152 is optimized for single layer PCB layout to facilitate a ground plane beneath the IC for shielding noise. VCOMP & COM pins are next to each other for a tight loop. VFB & OVP are located next to each other since both communicate to DC bus via resistor dividers. VCC & COM are located close to each other to facilitate placement of 1uF decoupling capacitor in very close proximity to the IC. Careful routing of the control loops & use of jumper wires to achieve STAR connection also enables a ground plane beneath IR1152 in IRAC1152-350W. Note that the ground plane does not function as a current carrying trace to COM pin since it is not a part of any loop i.e. the only connection to the ground plane is the COM pin to establish ground bias.
- **ISNS voltage filtering:-** Notice that R11 & C11, which are used for RC filtering the ISNS signal, are located close to the current sense resistor. This serves to filter the ISNS signal noise near the noise source (i.e. current sense resistor) rather than near the IC. Also, notice that the noise filter RC circuit is a dedicated loop by itself in order to prevent noise proliferation.

## Hardware Installation & Operating Procedure

The recommended test set-up for IRAC1152-350W is shown in Figure 1.

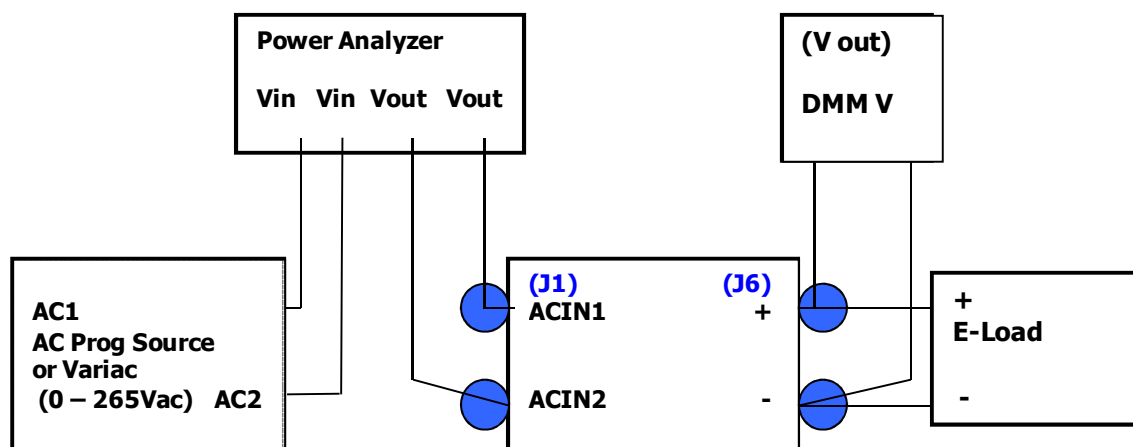

Figure 1 IRAC1152-350W test set-up

**Load Connection**

Connect high voltage resistive or electronic load, capable of 350W continuous power to connector J6 as shown in Figure 1. Pay attention to the polarity of the terminals in the connector. There is no minimum load requirement for operating IRAC1152-350W. The DC bus voltage is monitored at test-points VOUT and RTN. Always monitor the DC bus voltage to ensure that the capacitor voltage is discharged completely prior to adding or removing load connections from the demo board.

**AC Input Connection**

Connect a 60Hz AC power source, capable of operation up to 264VAC to connector J1 as shown in Figure 1. The AC input voltage can be monitored at test points AC-IN1 and AC-IN2. Once power is applied to demo board, potentially lethal high voltages will be present on board and necessary precautions should be taken to avoid serious injury. The use of an isolation transformer on the AC side is highly recommended, so that all the control signals on the test points can easily be probed by using regular oscilloscope probes. Though floating the ground potential of the scope is often practiced, it is not recommended. Failure to follow these guidelines so may result in personal injury or death.



**ATTENTION:** The IRAC1152-350W system contains dc bus capacitors & capacitors on the rectified AC line (C6, C9, C10, C21, C22), which take time to discharge after removal of main supply. There is a 470kΩ (R10) bleed resistor on the DC bus capacitor, whose voltage is monitored at test points VOUT and RTN. There is a 12kohm (R29) bleed resistor on the output of the Flyback power supply, whose voltage is monitored at test points VCC and COM. However, there is no bleed resistor across capacitor C22 located in the Flyback power supply and C6 locating in the main PFC circuit, both of which sustain the rectified AC voltage. Remove and lock out power from the IRAC1152-350W board before you attempt to disconnect or reconnect wires or perform service. Wait at least one minute after removing power to discharge the capacitor voltages. Do not attempt to service the reference design until all capacitor voltages have discharged to zero. Failure to do so may result in bodily injury or death.

**VCC Supply Connection (if necessary)**

If user desires to provide IR1152 VCC bias using an external DC supply in order to study the standby & start-up current requirements of IR1152, then onboard Flyback SMPS can be disconnected by implementing the following steps:

- i. Un-install jumper J13
- ii. Though not necessary, un-installing diode D8 is also recommended for safety reasons to fully disable the Flyback power supply from the
- iii. Input connector J15 can be used for providing external DC supply to bias the VCC pin of IR1152; Pay attention to the polarity of the terminals in the connector as shown in Figure 2.

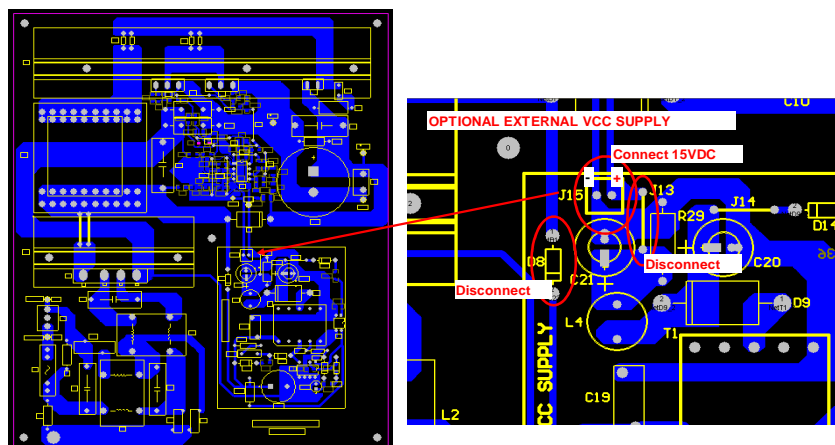

Figure 2: IRAC1152-350W external Vcc connection



**Power-up**

Once all the connections are made the system can be powered up. There is no minimum load requirement during power-up and the system can be powered-up at any load from 0W to 350W.

If the AC line is increased gradually:

- the onboard Flyback power supply will establish the VCC bias supply of 16VDC at around 35-40VAC
- the PFC converter will start boosting as soon as the IC exits the Brown-out fault condition during start-up - around an AC voltage of 65-70VAC at 0W load and at an AC voltage of 70-75VAC under the presence of any load.

If an external DC power supply is used for the VCC bias, then there is no strict biasing sequence for VAC and DC supply. It is OK to supply either voltage first.

## Performance Characterization

### DC Bus Voltage Regulation

DC bus voltage variation is less than 0.2% across line (85-264VAC) & load (0-350W). There is absolutely no minimum load requirement to maintain voltage regulation.

	350W	262.5W	175W	87.5W	35W	0W
85VAC	389.10	389.13	389.15	389.19	389.24	389.51
115VAC	389.15	389.17	389.19	389.20	389.26	389.59
180VAC	389.18	389.22	389.24	389.26	389.34	389.68
230VAC	389.21	389.24	389.26	389.31	389.45	389.69
264VAC	389.21	389.26	389.29	389.37	389.54	389.69

DC Bus voltage (in V) variation in IRAC1152-350W

### Power Factor

IRAC1152-350W delivers power factor greater than 0.98 at 350W, 115-230VAC. At light load condition, there is some drop in power factor which is primarily due to X-capacitors in EMI filter. By reducing the X-capacitors in the EM filter stage, the light load performance can be improved. This is demonstrated later in this document.

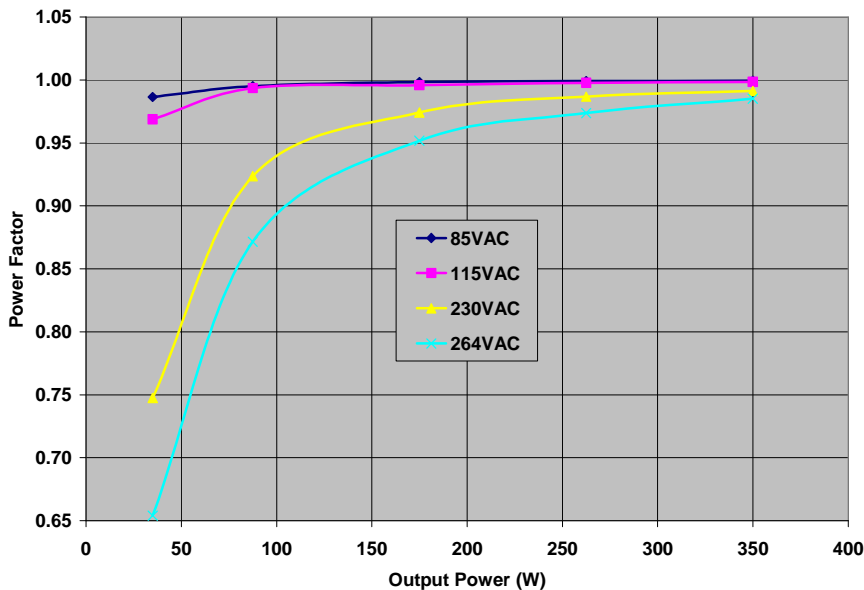

Figure 3. Power factor vs. Line/Load Variation of IRAC1152-350W

**Input Current Harmonics**

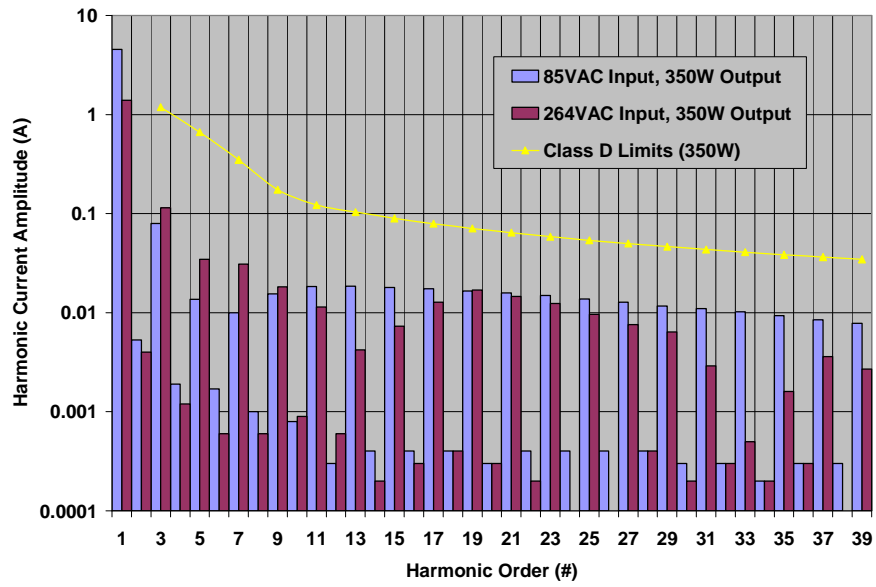

Figure 4. Current Harmonics at 85-264VAC, 350W

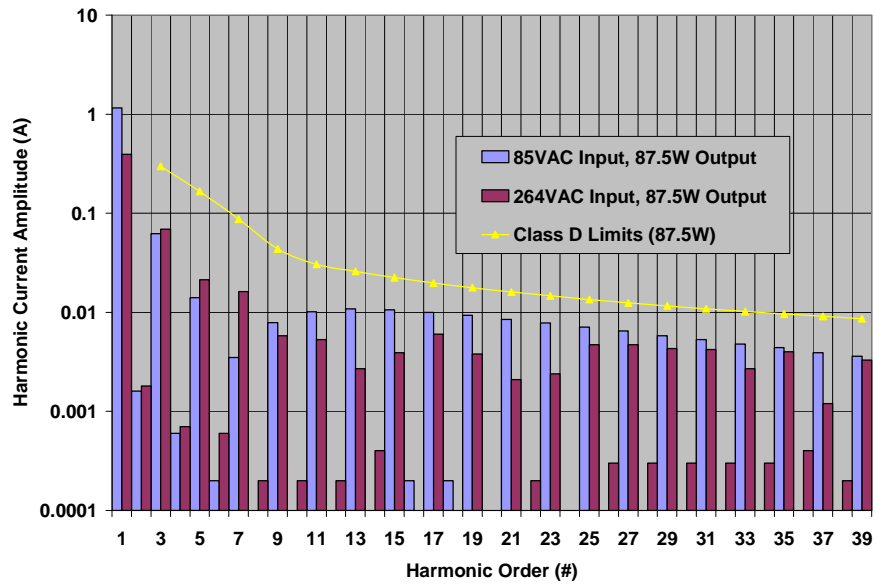

Figure 5. Current Harmonics at 85-264VAC, 87.5W (25% of rated power)

**Total Harmonic Distortion**

IRAC1152-350W delivers less than 10% of Total Harmonic Distortion at the rated 350W output power.

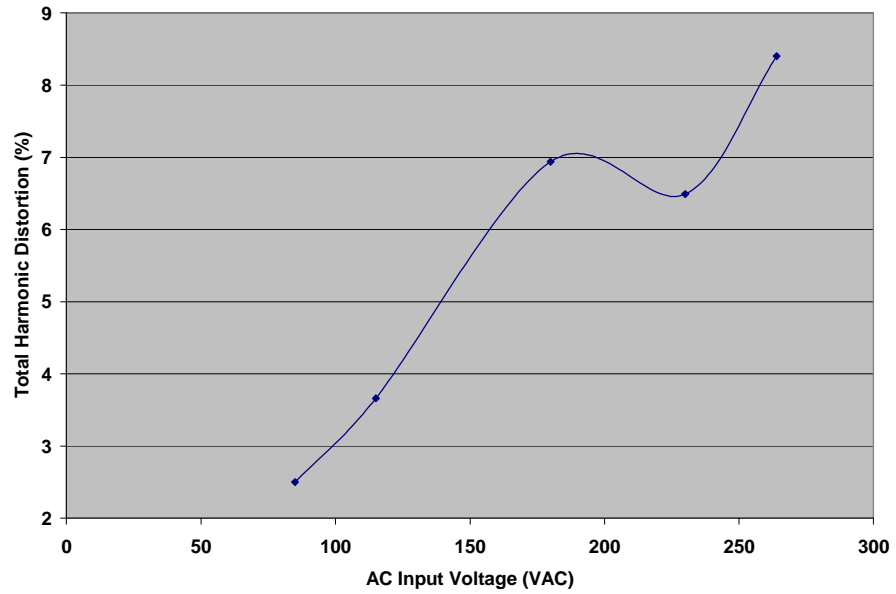
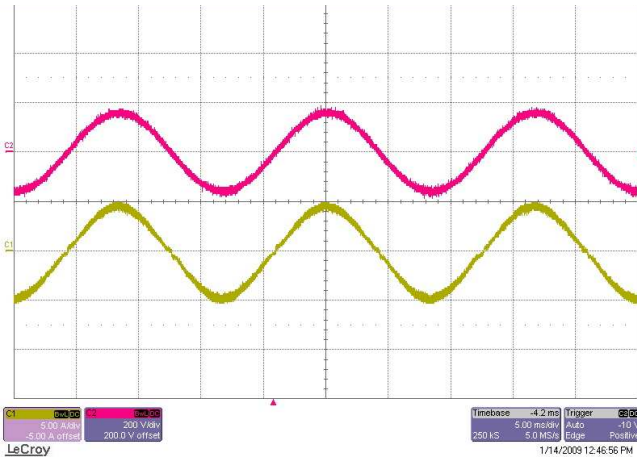
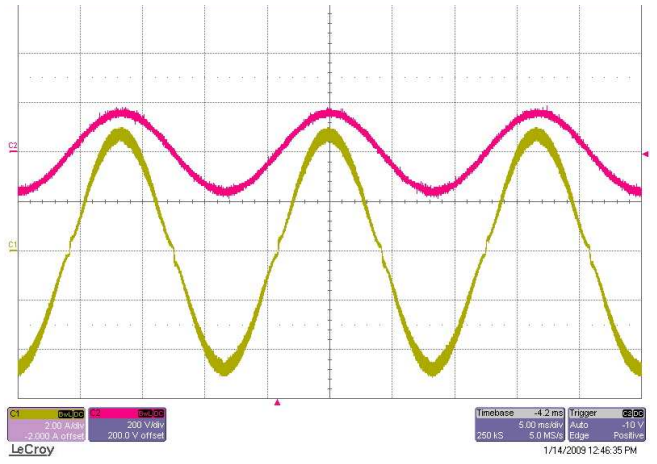

Figure 6. THD at 350W across 85-264VAC for IRAC1152-350W

## Steady-state Input Current Waveforms (Ch 2: Input Voltage, Ch1: Input Current)



85VAC, 350W



115VAC, 350W

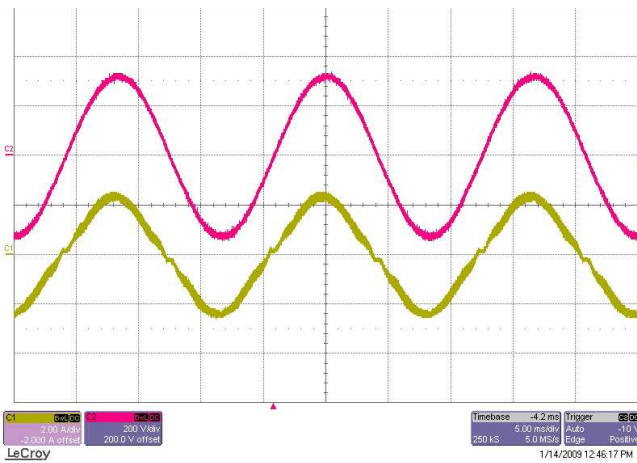

230VAC, 350W

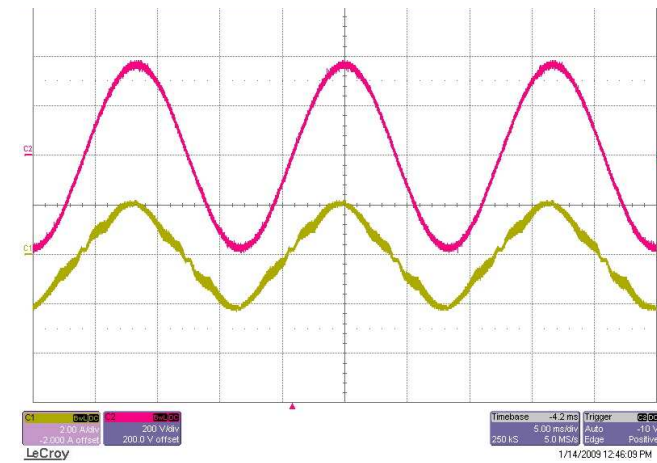

264VAC, 350W

**Effect of EMI Filter stage (X-capacitors) on Input Current**

The X-capacitors (C1, C2 & C5) in EMI filter causes a phase shift in input current with respect to the input AC voltage and “current steps” at VAC zero-crossings. This is more obvious at lower current amplitudes (such as at 264VAC, 350W condition). Notice however that the inductor current being regulated by the IC maintains very good symmetry with respect to the AC input voltage indicating that power factor correction stage is operating normally.

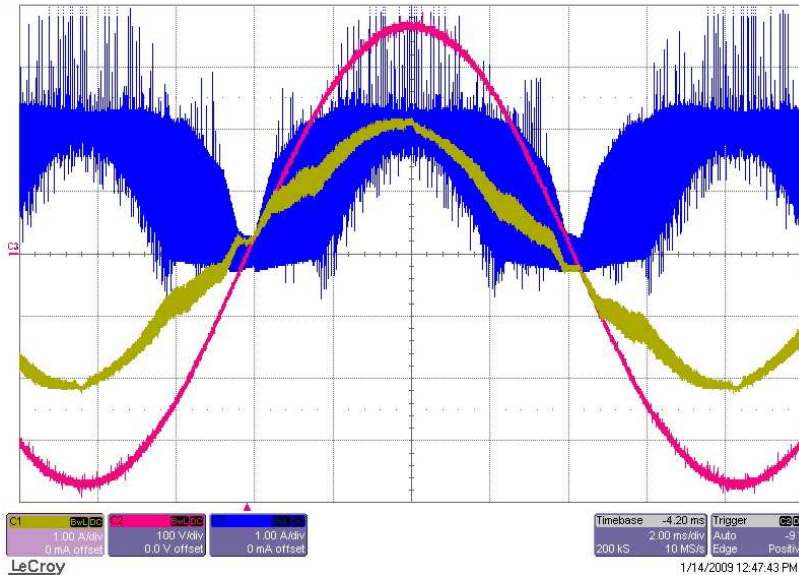

Figure 7. EMI filter stage causes phase-shift in Input Current Waveform (264VAC, 350W)

As mentioned earlier, the X-capacitors in the EMI stage contribute to drop in power factor at light load conditions. By reducing to a single stage EMI filter (remove C1, C2 & L1), the power factor at light load can be greatly improved. This is depicted in Figure 8 below.

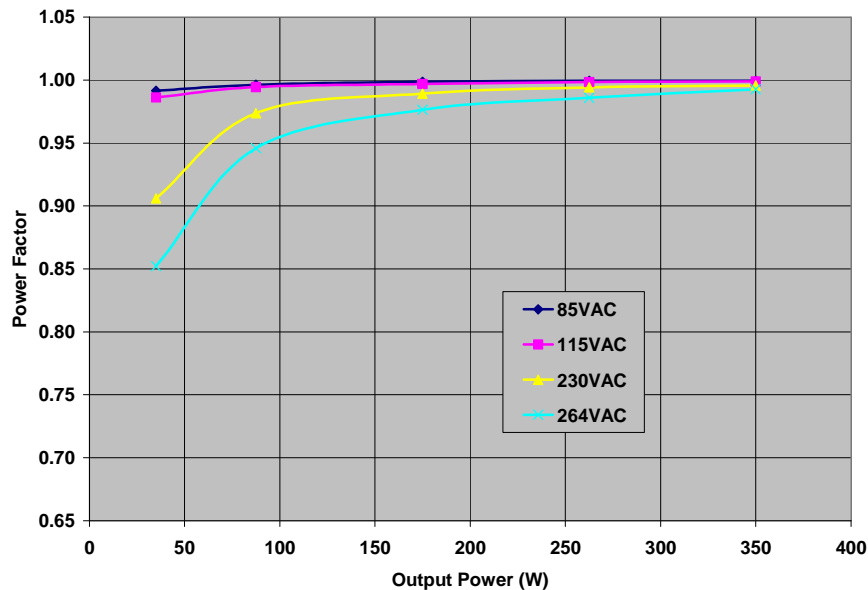

Figure 8. Power factor vs. Line/Load for modified IRAC1152-350W with single stage EMI filter

**DC Bus Capacitor Ripple Voltage**

The sizing of the DC bus capacitor, load condition, AC input voltage frequency etc determine the 2X AC frequency ripple in the DC bus capacitor. The DC bus capacitor ripple in IRAC1152-350W at 350W is less than 10V as seen in Figure 9 and 10.

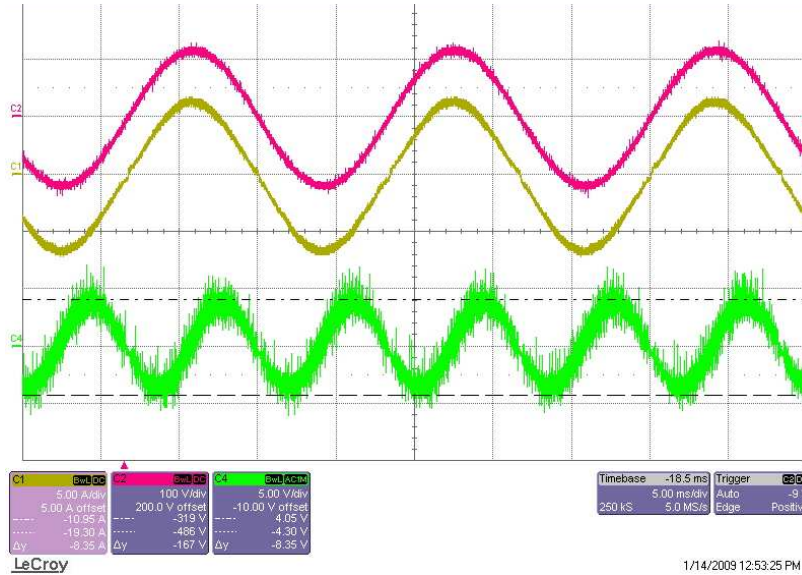

Figure 9. 2X AC frequency ripple in DC bus capacitor at 85VAC, 350W

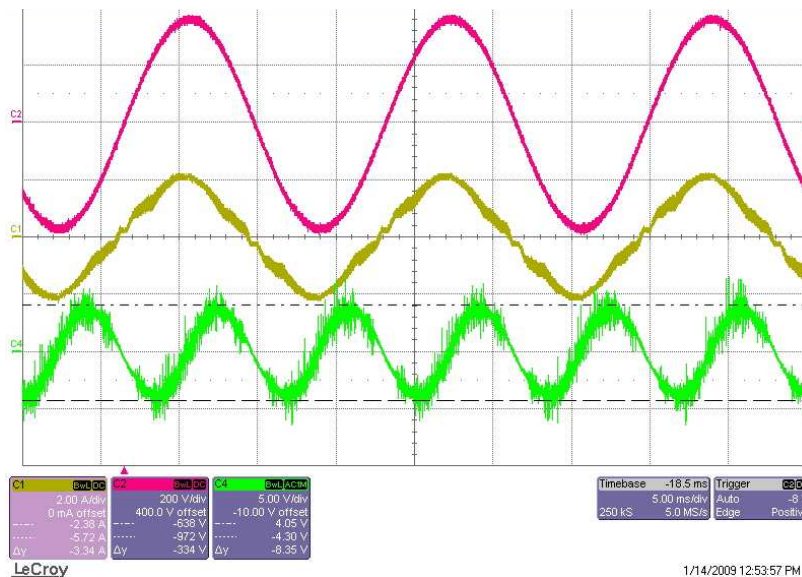
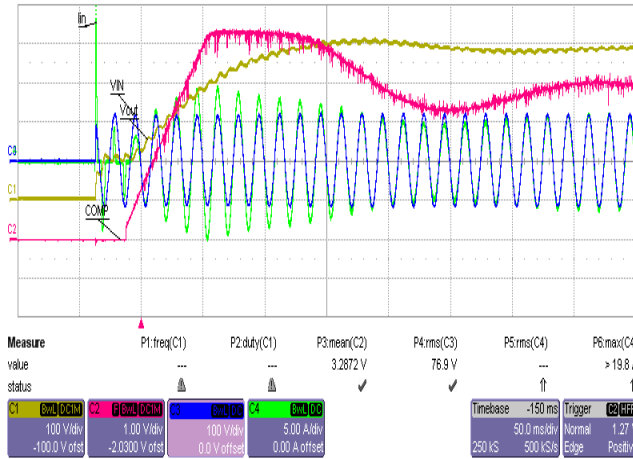

Figure 10. 2X AC frequency ripple in DC bus capacitor at 264VAC, 350W

### Start-up Current Waveforms at 100% load

The maximum time for system start-up, about 60msec, is encountered when IRAC1152-350W is powered up at minimum input voltage (85VAC) and maximum output power (350). The soft-start feature of the IC allows for a linear ramp in the VCOMP voltage, which allows a smooth build-up of AC input RMS current admitted into the PFC converter and DC bus capacitor voltage. Note that, prior to entering the soft-start mode, the IC is held under a Brown-out fault condition until VBOP exceeds the Brown-out Protection Enable threshold of 1.7V. Since the PFC voltage loop is a slow loop, the converter goes through a period where the DC bus voltage is under hysteretic OVP condition (between 103% and 106% of regulation voltage set-point) before the VCOMP voltage stabilizes near the steady stage voltage value.



85VAC, 350W

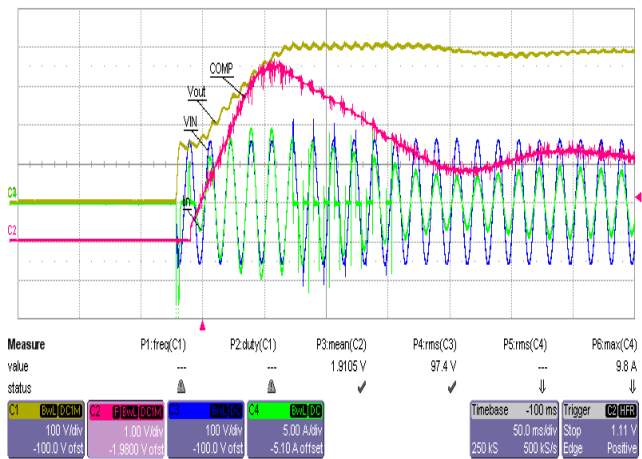

115VAC, 350W

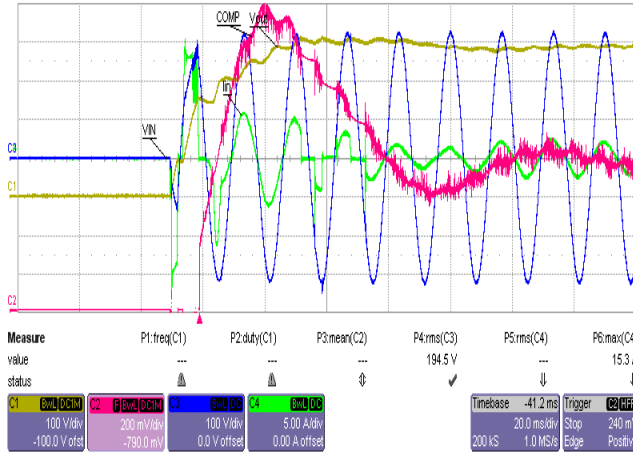

230VAC, 350W

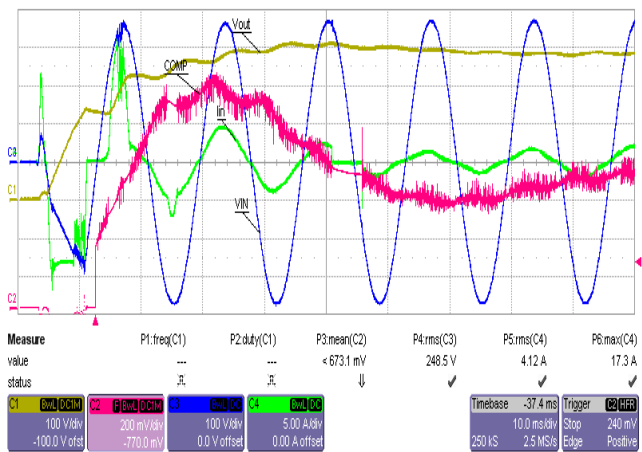

264VAC, 350W



No Load Start-up Current Waveforms

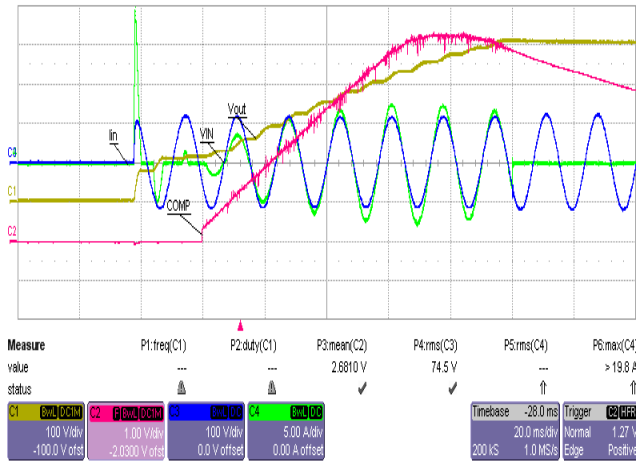

85VAC, 0W

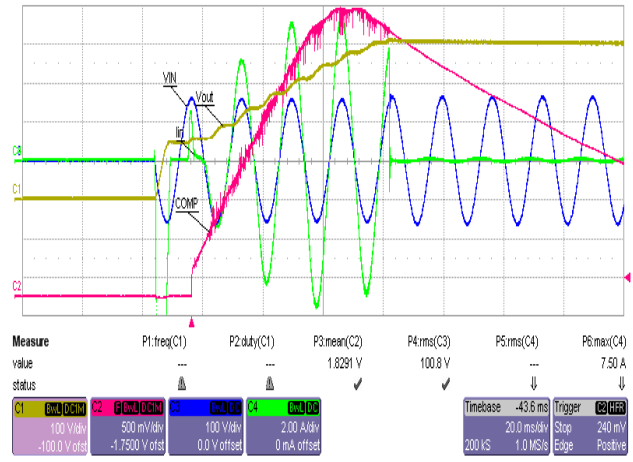

115VAC, 0W

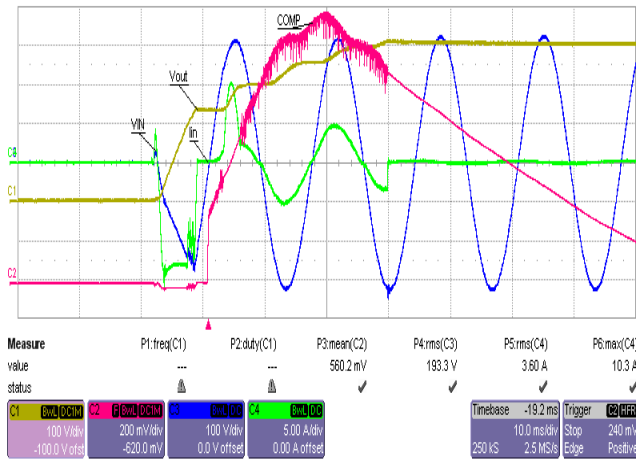

230VAC, 0W

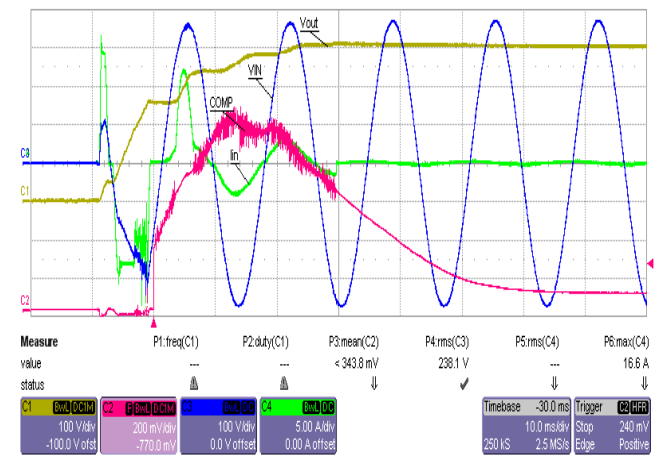

264VAC, 0W



Load Step Waveforms

- No-Load to Full-Load

Under a 0W to 300W load step at 115VAC, the maximum DC bus voltage undershoot is about 49V; the undershoot at 230Vac is 22V.

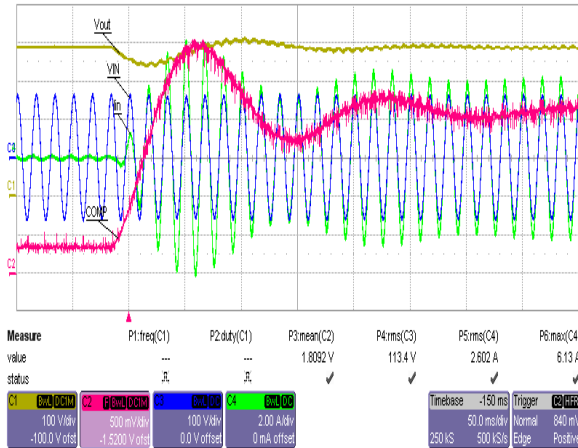

115VAC, 0W to 300W load step

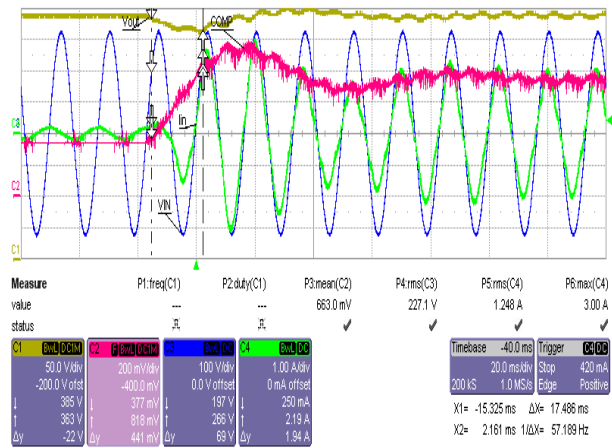

230VAC, 0W to 300W load step

- Full-load to No-Load

300W to 0W negative load step waveforms are presented below. In all cases, the OVP protection feature is encountered until the DC bus capacitor voltage discharges back to the regulation voltage.

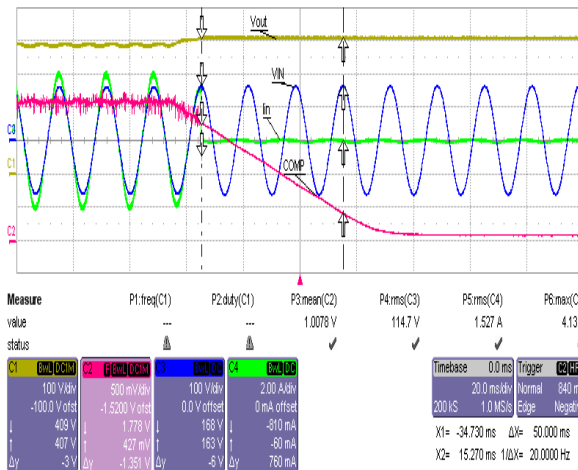

115VAC, 300W to 0W load step

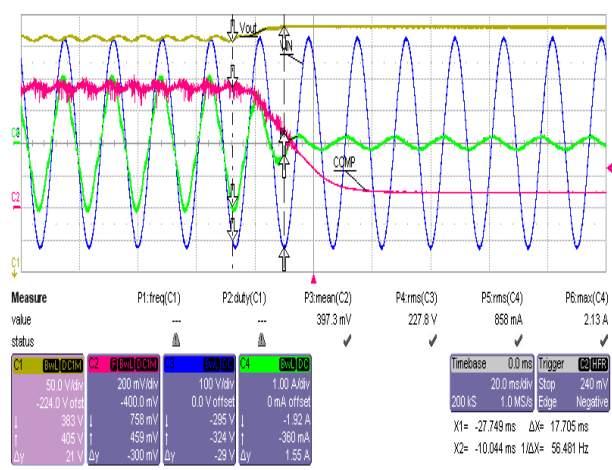

230VAC, 300W to 0W load step

### IRAC1152-350W Brown-Out Protection

At power up, if AC input voltage is lower than 75Vac, the BOP protection will hold the output of IR1152. Output voltage stays at the peak of input voltage. When AC input exceeds 75Vac, BOP voltage exceeds the BOP enable threshold. IR1152 starts Power Factor correction and  $V_{BOP}$  voltage drops to  $2/\pi$  of its original value. The hysteresis of the BOP prevents any bouncing between On and Off.

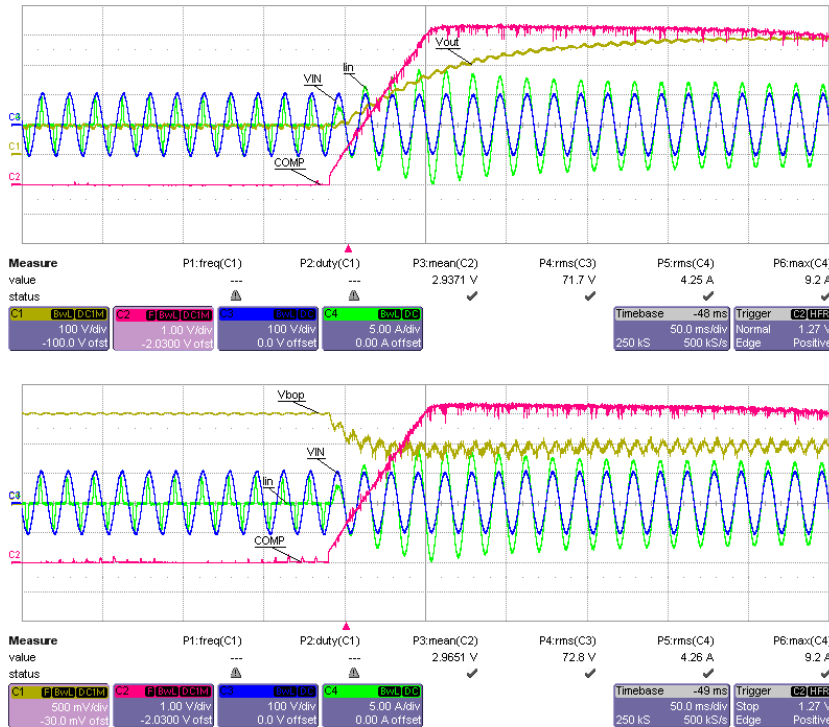

# IRAC1152-350W Schematics

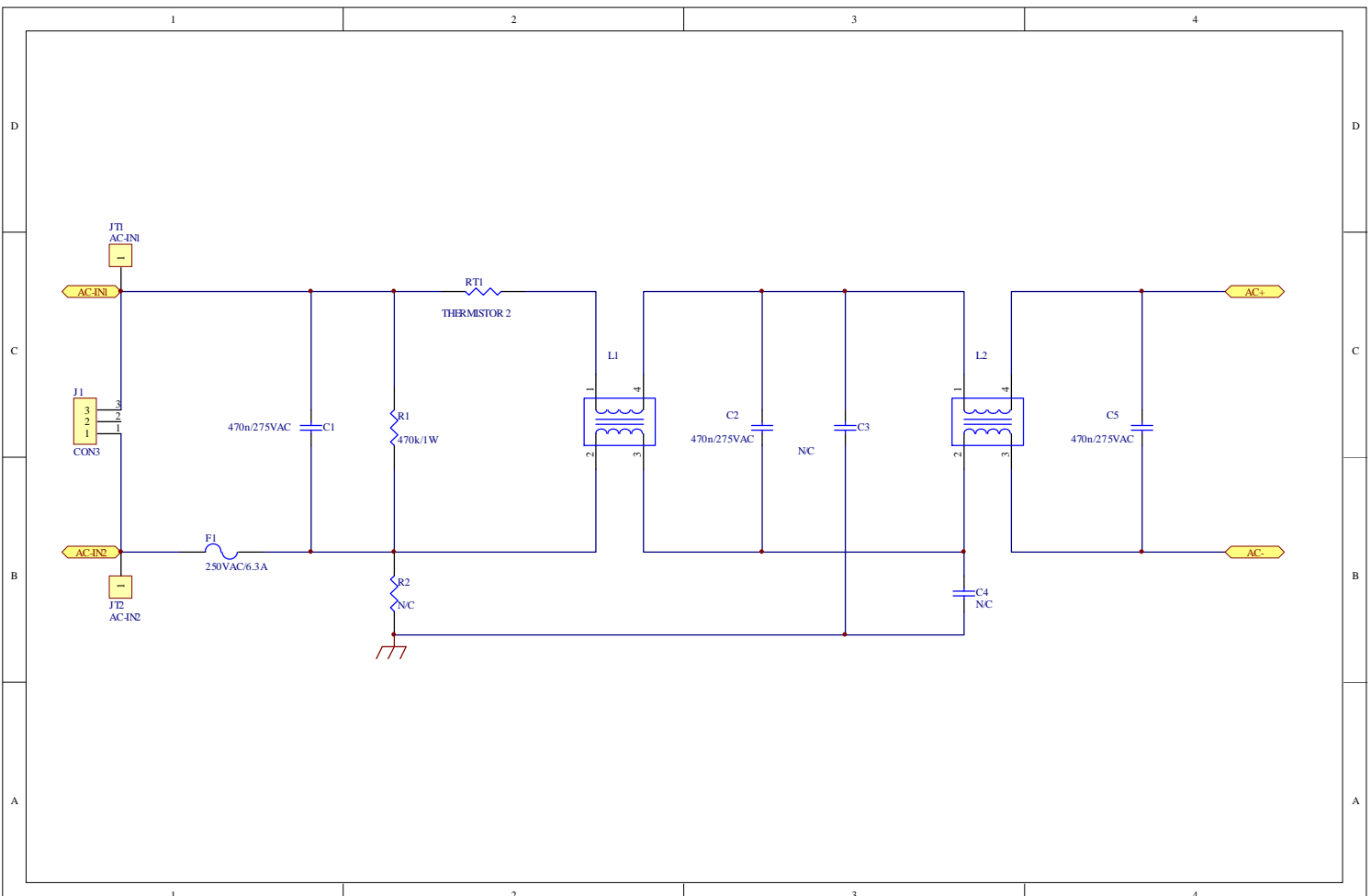

IRAC1152-350W EMI Filter Stage

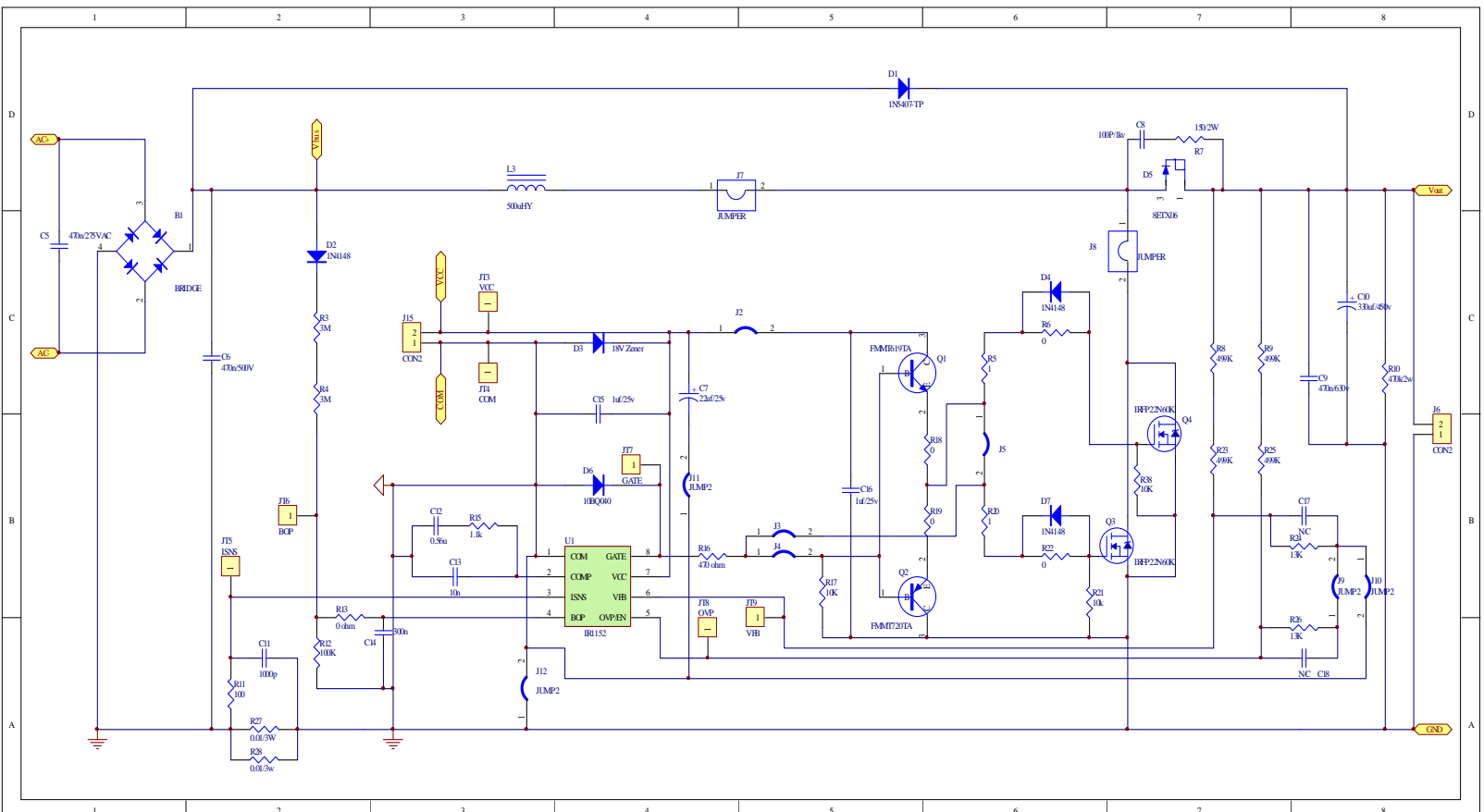

IRAC1152-350W Boost PFC Stage

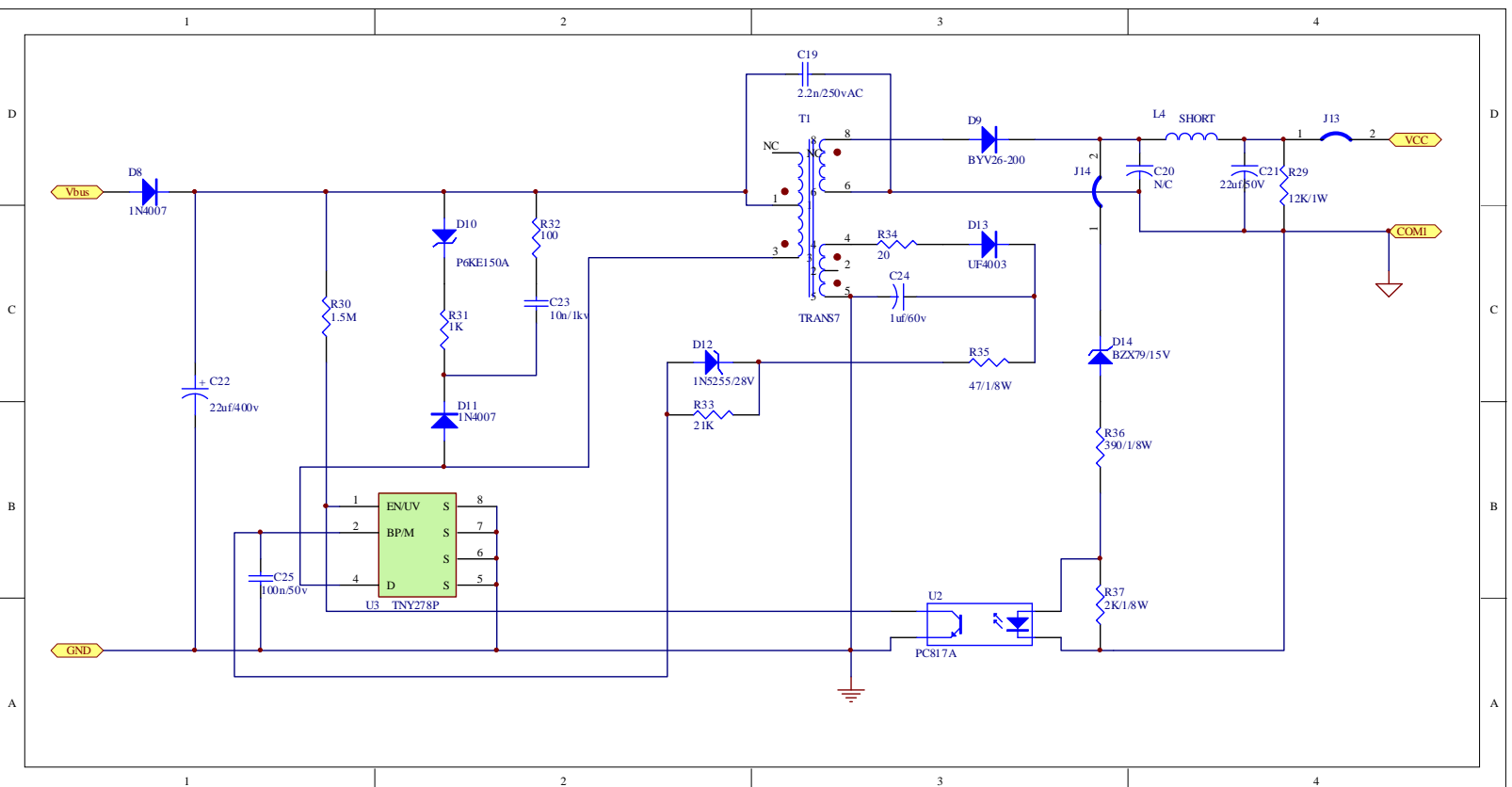

IRAC1152-350W Flyback SMPS Stage

## IRAC1152-350W Bill of Materials (BoM)

NO.	PART TYPE	PART DESCRIPTION	MANUFACTURER & PART#	QTY	DESIGNATOR
1	BN PCB	PCB, IR1152-350W_V4.0		1	
2	Bridge	RECT BRIDGE GPP 600V 8A GBU	YJ GBU806	1	B1
3	Discrete Capacitor	CAP THR, 0.47UF 250/275VAC ECQ-UL	Panasonic ECQ-U2A474ML DIGIKEY P10734-ND	3	C1,C2,C5
4	Electrolytic Capacitor	CAP THA, 330uF AL ELEC 450V 20%---40*35*10	SAMWHA HE 450V 330UF 35*40 P=10 JIANGHAI HE 450V 330UF 35*40 P=10	1	C10
5	Chip Capacitor	CAP SMT, 1000pF 1206 CER 50V 10% X7R		1	C11
6	Chip Capacitor	CAP SMT, 0.56uF 1206 CER 50V 10% X5R		1	C12
7	Chip Capacitor	CAP SMT, 10000pF 1206 CER 50V 10% X7R		1	C13
8	Chip Capacitor	CAP SMT, 0.1uF 1206 CER 50V 10% X7R		2	C14,C25
9	Chip Capacitor	CAP SMT, 1uF 1210 CER 50V 10% X5R		2	C15,C16
10	Discrete Capacitor	CAP THR, 2.2nF 400V, 20%, Disc Y1	Cera-Mite 440LD22	1	C19
11	Electrolytic Capacitor	CAP THR, 22uF, AL ELEC, 50V (2mmlS)---11.5*5*2.5		1	C21
12	Electrolytic Capacitor	CAP THR, 22 uF, 400 V, Electrolytic, Low ESR, 901 mΩ, (20 x 16x7.5)		1	C22
13	Discrete Capacitor	CAP THR, 10 nF, 1 kV, 20%, Disc Ceramic	Vishay/Sprague 562R5HKMS10	1	C23
14	Electrolytic Capacitor	CAP THR, 1uF,ELEC 50V 20%---11*5*2 105 °C		1	C24
15	Discrete Capacitor	CAP THR, 0.47uF CER 630V 10%	Panasonic ECQ-E6474KF DIGIKEY EF6474-ND	2	C6,C9
16	Tantalum capacitor	CAP SMT, 22uF 7343-31 TANT 35V 20%	PANASONIC EEJ-L1VD226R DIGIKEY P11302CT-ND	1	C7
17	Discrete Capacitor	CAP THR, 100PF 1KVDC CERAMIC SL/GP 5% LS-	Panasonic ECC-D3A101JGE DIGIKEY P10804-ND	1	C8
18	Diode	DIODE, RECTIFIER GPP 800V 3A DO-201AD	DIODES 1N5407-T DIGIKEY 1N5407DICT-ND	1	D1
19	Diode	DIODE, TVS 150V 600W 5% UNI AXL	MOUSER 625-P6KE150A-E3	1	D10
20	Diode	DIODE, STANDARD 1N4007 50V 1A DO-41---DO-41	YJ--1N4007	2	D8,D11
21	Diode	DIODE, Zener Diode 36V	MOUSER 512-1N5258B	1	D12
22	Diode	DIODE, GPP FAST 1A 200V DO-41	Fairchild UF4003 DIGIKEY UF4003-ND	1	D13
23	Diode	DIODE, ZENER 15V 1W 5% DO-41	DIODES 1N4744A-T DIGIKEY 1N4744ADICT-ND	1	D14
24	Diode	DIODE SMT, FAST SWITCHING 100V 5uA 500mW MINI-MELF DL-35	DIODES INC LL4148 DIGIKEY LL4148DITR-ND	3	D2,D4,D7
25	Diode	DIODE SMT, ZENER 500MW 18V SOD-123	DIODES BZT52C18-7-F DIGIKEY BZT52C18-FDICT-ND	1	D3
26	Diode	DIODE, HYPERFAST 600V 8A TO-220AC	DIGIKEY 8ETX06PBF-ND	1	D5
27	Diode	DIODE SMT, SCHOTTKY 40V 1A SMB	DIGIKEY 10BQ040-ND	1	D6
28	Diode	DIODE, GPP 3A 200V HI EFF DO-201AE	DIGIKEY EGP30D-TPCT-ND	1	D9
29	Fuse base			2	F1
30	Connector	CONN, HDR, 3P,		2	J1,J6
31	Wire	WIRE, 24 AWG,AWM1007		0.25	J2,J4,J5,J9,J10,J11,J12,J13,J14,J17,L4
32	Wire	WIRE, 16 AWG,AWM1007		0.08	J7,J8
33	Connector	CONN, HDR, 1x2, 0.100" PITCH, 0.025 SQ POST, TIN (0.135"/0.380") KEYED	MOLEX 22-23-2021 DIGIKEY WM4200-ND	1	J15
34	Test point		KEYSTONE 5007 DIGIKEY 5007K-ND	7	
35	Inductor	EMI Common Mode Choke 7A 10mH	TNC KOREA CV507100BS	2	L1,L2
36	Inductor	600uH Boost Inductor custom designed by Precision	Precision 019-4894-01R proto-2	1	L3
37	NPN Transistor	DIODE SMT, NPN 50V 2000MA SOT-23	Zetex FMMT619TA DIGIKEY FMMT619CT-ND	1	Q1
38	PNP Transistor	DIODE SMT, PNP -40V -1500MA SOT-23	Zetex FMMT720TA DIGIKEY FMMT720CT-ND	1	Q2
39	MOSFET	TRANS, MOSFET N-CHAN 600V 20A TO-247	Fairchild FCH20N60 DIGIKEY FCH20N60-ND	2	Q3,Q4
40	Discrete resistor	RES, MF 470K-OHM 1W 5%		2	R1,R10
41	Chip Resistor	RES SMT, 100-OHM 1/4W 1% 1206		1	R11
42	Chip Resistor	RES SMT, 100K-OHM 1/4W 5% 1206		1	R12
43	Chip Resistor	RES SMT, 0-OHM 1/4W 5% 1206		3	R13,R16,R19
44	Chip Resistor	RES SMT, 1.1K-OHM 1/4W 1% 1206		1	R15
45	Chip Resistor	RES SMT, 10K-OHM 1/4W 1% 1206		3	R17,R21,R38
46	Chip Resistor	RES SMT, 5.1-OHM 1/4W 1% 1206		1	R18

NO.	PART TYPE	PART DESCRIPTION	MANUFACTURER & PART#	QTY	DESIGNATOR
47	Chip Resistor	RES SMT, 1.5-OHM 1/4W 1% 1206		2	R5,R20
48	Chip Resistor	RES SMT, 3.9-OHM 1/4W 1% 1206		2	R6,R22
49	Chip Resistor	RES SMT, 1M-OHM 1/4W 1% 1210		4	R8,R9,R23,R25
50	Chip Resistor	RES SMT, 26.1K-OHM 1/4W 1% 1206		2	R24,R26
51	Discrete resistor	RES, 50m-ohm CURRENT SENSE RESISTOR 5W	HMR KOREA 50mohm,MPR-5R(S) series,TWO LEAD TYPE	1	R27
52	Chip Resistor	RES SMT, 3M-OHM 1/4W 1% 1206		2	R3,R4
53	Discrete resistor	RES, CF 12K-OHM 1W 5%		1	R29
54	Discrete resistor	RES, CF1.5M-OHM 1/2W 5%		1	R30
55	Chip Resistor	RES SMT, 1.0K-OHM 1/4W 1% 1206		1	R31
56	Discrete resistor	RES, CF 100-OHM 1/4W 5%		1	R32
57	Chip Resistor	RES SMT, 21K-OHM 1/4W 1% 1206		1	R33
58	Discrete resistor	RES, CF 20-OHM 1/4W 5%		1	R34
59	Chip Resistor	RES SMT, 47-OHM 1/4W 1% 1206		1	R35
60	Chip Resistor	RES SMT, 390-OHM 1/4W 1% 1206		1	R36
61	Chip Resistor	RES SMT, 2.0K-OHM 1/4W 1% 1206		1	R37
62	Discrete resistor	RES, MF 150-OHM 2W 5%		1	R7
63	Discrete resistor	CURRENT LIMITER INRUSH 6A STEADY STATE	DIGIKEY KC004L-ND	1	RT1
64	Transformer	EE25V Switch transformer	SANTRONICS SNX-1380	1	T1
65	IC	IC, PFC Control IC IR1152--SO-8	IR IR1152S	1	U1
66	Diode	DIODE, PHOTOCOUPLER TRAN OUT 4-DIP	SHARP--PC817X2	1	U2
67	IC	IC, SWITCH OFF-LINE 10/28W TNY278PN--8P DIP	Power Integrations TNY278PN DIGIKEY 596-1094-5-ND	1	U3
68	-	UNINSTALLED PARTS	-	-	C17,C18,C20,C3,C4,R2,R28,
69	Fuse	FUSE 6.3A/250V 5X20MM FAST	DIGIKEY F953-ND	1	F1
70	Fuse Cover	Vinyl Fuse Cover	DIGIKEY 3527CK-ND	1	
71	Heatsink	HEATSINK, IRAC1152-350W Heatsink for Boost FET/Diode---160mm length	AAVID 78195(160mm)	1	
72	Heatsink	HEATSINK, IRAC1152-350W Heatsink for Bridge rectifier---76mm length	AAVID 78195(76mm)	1	
73	Clip	HEATSINK CLIP, Aavid MAX Clip 03 for TO-247 for Q3, Q4 & B1	AAVID MAX03(406097) MOUSER 532-MAXCLIP03	3	
74	Clip	HEATSINK CLIP, Aavid MAX Clip 01 for TO-220 for D5	AAVID MAX01(406098) MOUSER 532-MAXCLIP01	1	
75	Screw			5	
76	Spring Washer			5	
77	Washer			5	
78	Standoff			5	
79	Insulation Pad	For D5 (TO-220)		1	
80	Insulation Pad	For Q3 & Q4 (TO-3P, 25X19)		2	
81	Screw			5	
82	Standoff	HW, SPACER, M3 x 18mm,NYLON--M3*18		5	
83	Label	LABEL, 22.86x6.35		1	
84	Anti-static Bag	400x300		1	

## IRAC1152-350W PCB & Component Layout

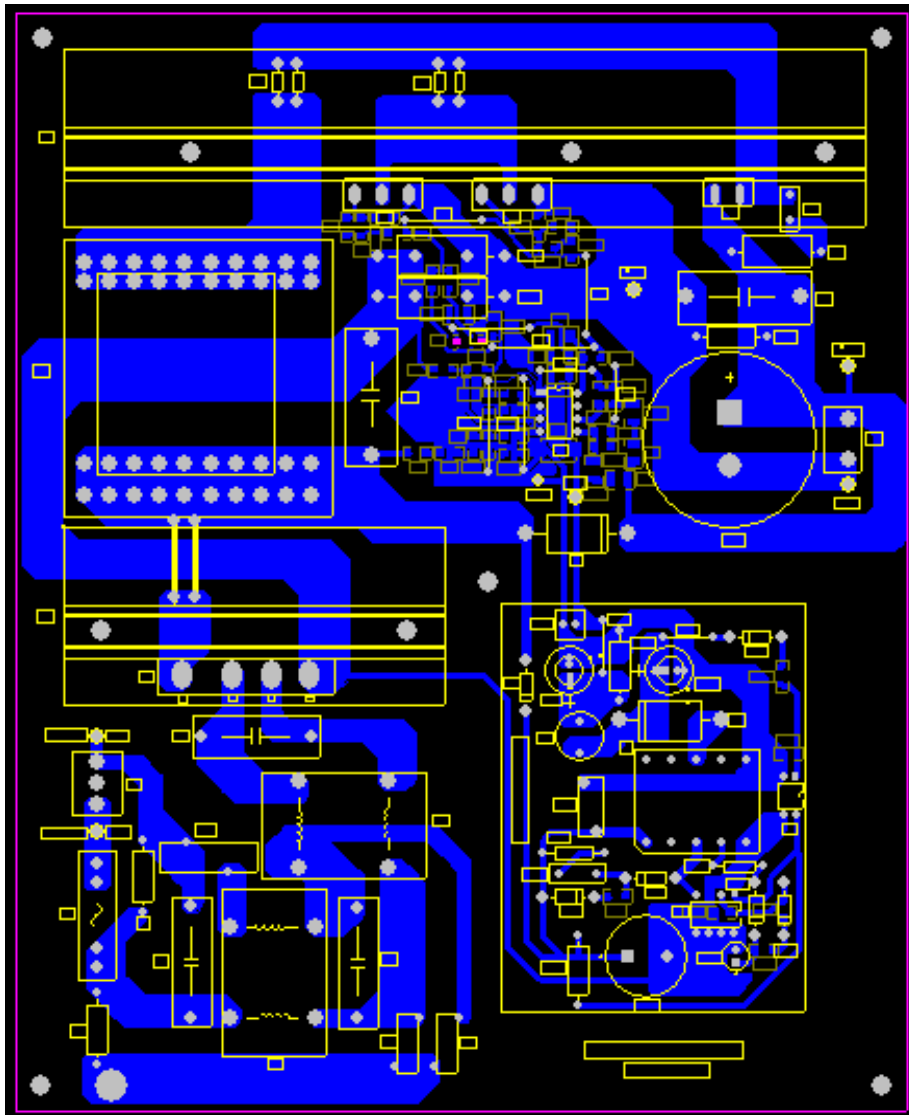

The information provided in this document is believed to be accurate and reliable. However, International Rectifier assumes no responsibility for the consequences of the use of this information. International Rectifier assumes no responsibility for any infringement of patents or of other rights of third parties which may result from the use of this information. No license is granted by implication or otherwise under any patent or patent rights of International Rectifier. The specifications mentioned in this document are subject to change without notice. This document supersedes and replaces all information previously supplied.

For technical support, please contact IR's Technical Assistance Center

<http://www.irf.com/technical-info/>

**WORLD HEADQUARTERS:**

233 Kansas St., El Segundo, California 90245  
Tel: (310) 252-7105