

SECTION A-A  
(VIEW FROM FRONT)

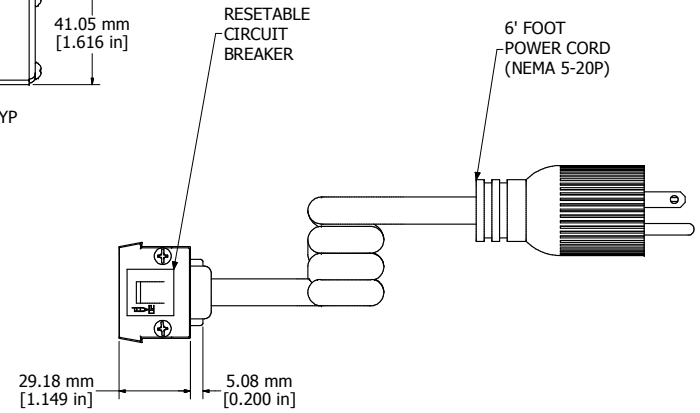

ASSEMBLY - VIEW FROM END



ASSEMBLY - VIEW FROM SIDE

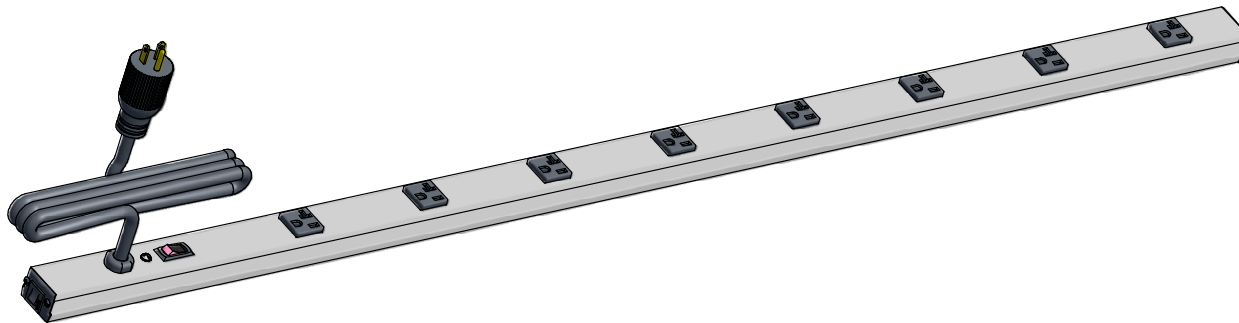

ISOMETRIC VIEW

<b>1589H48F1</b>
Finish - Case - Anodized Aluminum Extrusion
Ends - ABS Plastic
Rated - 125 VAC, 60 Hz, 20 Amps
Approvals - CSA Certified Standards C22.2 (No. 21-95, 42-99) - UL Listed Standard UL1363
<b>Cord Length</b>
1589H48F1 - 6' Foot Power Cord (NEMA 5-20P)
1589H48G1 - 15' Foot Power Cord (NEMA 5-20P)
<b>Accessories Included</b>
Mounting Bracket Kit with Hardware

