

IRG6S320UPbF

Features

- Advanced Trench IGBT Technology
- Optimized for Sustain and Energy Recovery circuits in PDP applications
- Low $V_{CE(on)}$ and Energy per Pulse (E_{PULSE}^{TM}) for improved panel efficiency
- High repetitive peak current capability
- Lead Free package

Key Parameters		
$V_{CE\ min}$	330	V
$V_{CE(ON)}\ typ.\ @\ I_C = 24A$	1.45	V
$I_{RP}\ max\ @\ T_C = 25^\circ C$	160	A
$T_J\ max$	150	$^\circ C$

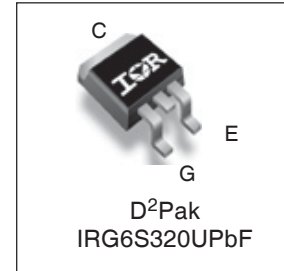
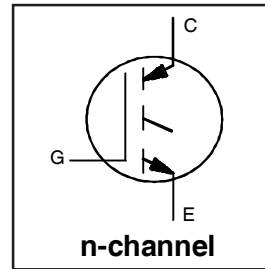

G	C	E
Gate	Collector	Emitter

Description

This IGBT is specifically designed for applications in Plasma Display Panels. This device utilizes advanced trench IGBT technology to achieve low $V_{CE(on)}$ and low E_{PULSE}^{TM} rating per silicon area which improve panel efficiency. Additional features are 150 $^\circ C$ operating junction temperature and high repetitive peak current capability. These features combine to make this IGBT a highly efficient, robust and reliable device for PDP applications.

Absolute Maximum Ratings

	Parameter	Max.	Units
V_{GE}	Gate-to-Emitter Voltage	± 30	V
$I_C @ T_C = 25^\circ C$	Continuous Collector Current, $V_{GE} @ 15V$	50 ④	A
$I_C @ T_C = 100^\circ C$	Continuous Collector, $V_{GE} @ 15V$	25	
$I_{RP} @ T_C = 25^\circ C$	Repetitive Peak Current ①	160	
$P_D @ T_C = 25^\circ C$	Power Dissipation	114	W
$P_D @ T_C = 100^\circ C$	Power Dissipation	45	
	Linear Derating Factor	0.91	W/ $^\circ C$
T_J	Operating Junction and	-40 to + 150	$^\circ C$
T_{STG}	Storage Temperature Range		
	Soldering Temperature for 10 seconds		

Thermal Resistance

	Parameter	Typ.	Max.	Units
$R_{\theta JC}$	Junction-to-Case ②	—	1.1	$^\circ C/W$

Electrical Characteristics @ $T_J = 25^\circ\text{C}$ (unless otherwise specified)

	Parameter	Min.	Typ.	Max.	Units	Conditions
BV_{CES}	Collector-to-Emitter Breakdown Voltage	330	—	—	V	$V_{GE} = 0V, I_{CE} = 500\mu A$
$V_{(BR)ECS}$	Emitter-to-Collector Breakdown Voltage ^③	30	—	—	V	$V_{GE} = 0V, I_{CE} = 1 A$
$\Delta BV_{CES}/\Delta T_J$	Breakdown Voltage Temp. Coefficient	—	0.30	—	V/ $^\circ\text{C}$	Reference to 25°C , $I_{CE} = 1\text{mA}$
$V_{CE(on)}$	Static Collector-to-Emitter Voltage	—	1.20	—	V	$V_{GE} = 15V, I_{CE} = 12A$ ^③
		—	1.45	1.65		$V_{GE} = 15V, I_{CE} = 24A$ ^③
		—	1.95	—		$V_{GE} = 15V, I_{CE} = 48A$ ^③
		—	2.20	—		$V_{GE} = 15V, I_{CE} = 60A$ ^③
		—	2.26	—		$V_{GE} = 15V, I_{CE} = 48A, T_J = 150^\circ\text{C}$ ^③
$V_{GE(th)}$	Gate Threshold Voltage	2.6	—	5.0	V	$V_{CE} = V_{GE}, I_{CE} = 250\mu A$
$\Delta V_{GE(th)}/\Delta T_J$	Gate Threshold Voltage Coefficient	—	-10	—	mV/ $^\circ\text{C}$	
I_{CES}	Collector-to-Emitter Leakage Current	—	1.0	10	μA	$V_{CE} = 330V, V_{GE} = 0V$
		—	5.0	—		$V_{CE} = 330V, V_{GE} = 0V, T_J = 100^\circ\text{C}$
		—	20	100		$V_{CE} = 330V, V_{GE} = 0V, T_J = 125^\circ\text{C}$
		—	75	—		$V_{CE} = 330V, V_{GE} = 0V, T_J = 150^\circ\text{C}$
I_{GES}	Gate-to-Emitter Forward Leakage	—	—	100	nA	$V_{GE} = 30V$
	Gate-to-Emitter Reverse Leakage	—	—	-100	nA	$V_{GE} = -30V$
g_{fe}	Forward Transconductance	—	28	—	S	$V_{CE} = 25V, I_{CE} = 12A$
Q_g	Total Gate Charge	—	46	—	nC	$V_{CE} = 200V, I_C = 12A, V_{GE} = 15V$ ^④
Q_{gc}	Gate-to-Collector Charge	—	7.7	—	nC	
$t_{d(on)}$	Turn-On delay time	—	24	—	ns	$I_C = 12A, V_{CC} = 196V$ $R_G = 10\Omega, L = 210\mu H, L_S = 150\text{nH}$ $T_J = 25^\circ\text{C}$
t_r	Rise time	—	20	—		
$t_{d(off)}$	Turn-Off delay time	—	89	—		
t_f	Fall time	—	70	—		
$t_{d(on)}$	Turn-On delay time	—	23	—	ns	$I_C = 12A, V_{CC} = 196V$ $R_G = 10\Omega, L = 200\mu H, L_S = 150\text{nH}$ $T_J = 150^\circ\text{C}$
t_r	Rise time	—	52	—		
$t_{d(off)}$	Turn-Off delay time	—	130	—		
t_f	Fall time	—	140	—		
t_{st}	Shoot Through Blocking Time	100	—	—	ns	$V_{CC} = 240V, V_{GE} = 15V, R_G = 5.1\Omega$
E_{PULSE}	Energy per Pulse	—	240	—	μJ	$L = 220\text{nH}, C = 0.10\mu F, V_{GE} = 15V$ $V_{CC} = 240V, R_G = 5.1\Omega, T_J = 25^\circ\text{C}$
		—	280	—		$L = 220\text{nH}, C = 0.10\mu F, V_{GE} = 15V$ $V_{CC} = 240V, R_G = 5.1\Omega, T_J = 100^\circ\text{C}$
ESD	Human Body Model	Class 2 (Per JEDEC standard JESD22-A114)				
	Machine Model	Class B (Per EIA/JEDEC standard EIA/JESD22-A115)				
C_{ies}	Input Capacitance	—	1160	—	pF	$V_{GE} = 0V$
C_{oes}	Output Capacitance	—	61	—		$V_{CE} = 30V$
C_{res}	Reverse Transfer Capacitance	—	38	—		$f = 1.0\text{MHz}$, See Fig.13
L_C	Internal Collector Inductance	—	5.0	—	nH	Between lead, 6mm (0.25in.)
L_E	Internal Emitter Inductance	—	13	—		from package and center of die contact

④ Packaging limitation for this device is 42A.

Notes:

- ① Half sine wave with duty cycle ≤ 0.05 , $t_{on} = 2\mu\text{sec}$.
- ② R_θ is measured at T_J of approximately 90°C .
- ③ Pulse width $\leq 400\mu\text{s}$; duty cycle $\leq 2\%$.

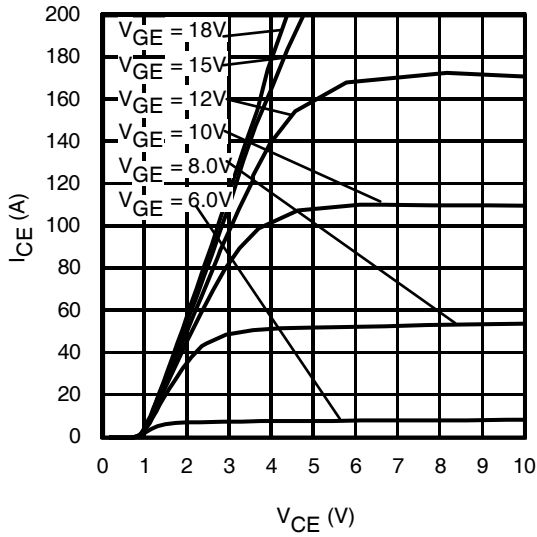

Fig 1. Typical Output Characteristics @ 25°C

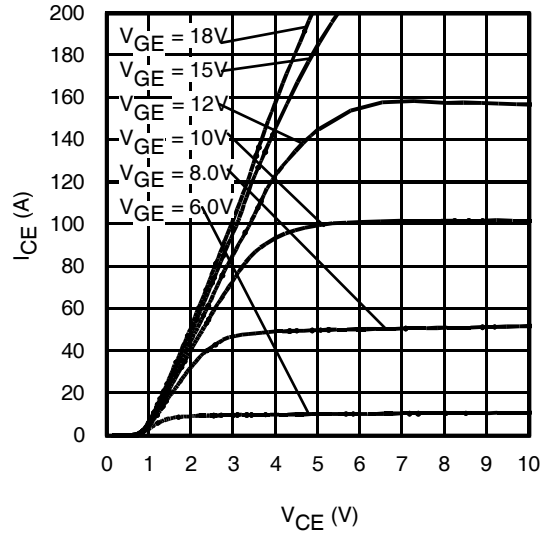

Fig 2. Typical Output Characteristics @ 75°C

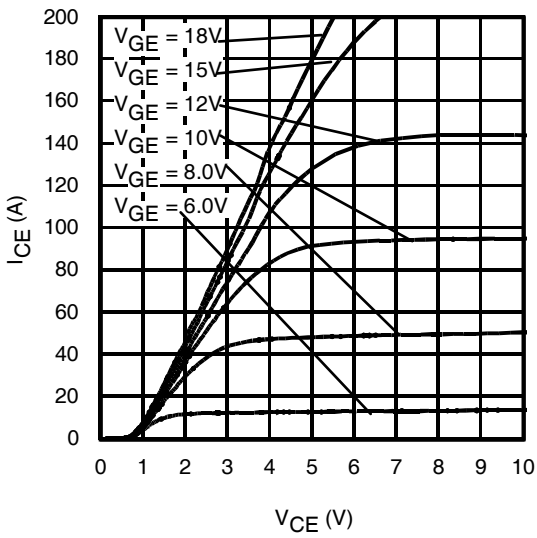

Fig 3. Typical Output Characteristics @ 125°C

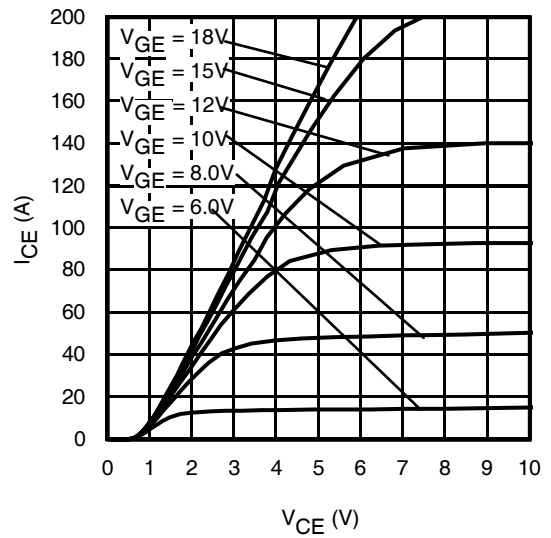

Fig 4. Typical Output Characteristics @ 150°C

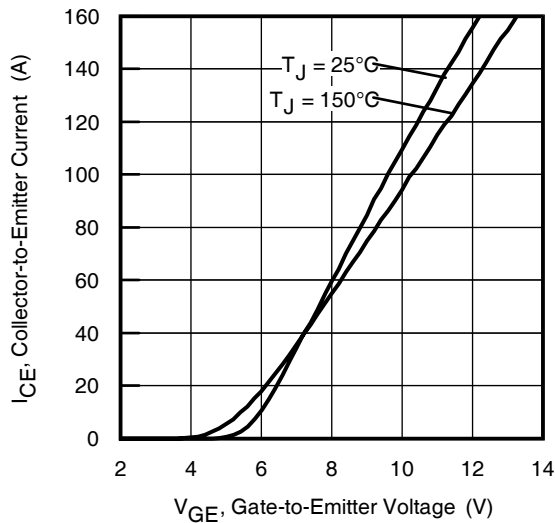

Fig 5. Typical Transfer Characteristics

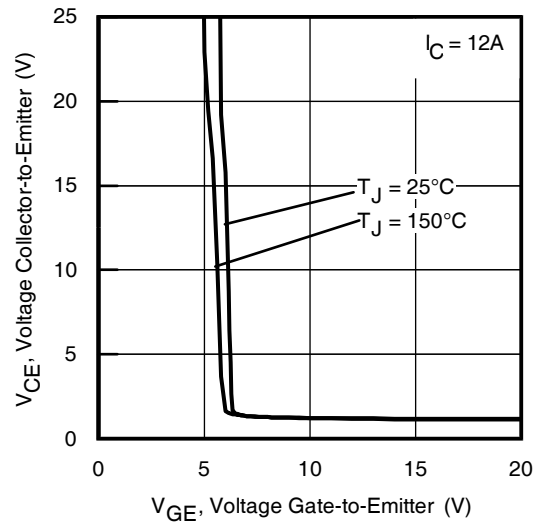

Fig 6. $V_{CE(ON)}$ vs. Gate Voltage

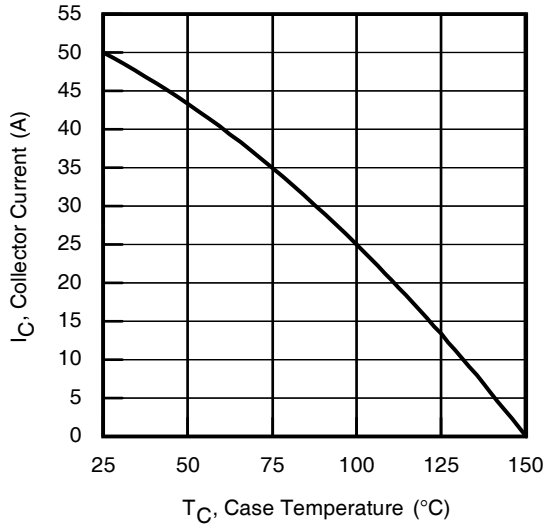

Fig 7. Maximum Collector Current vs. Case Temperature

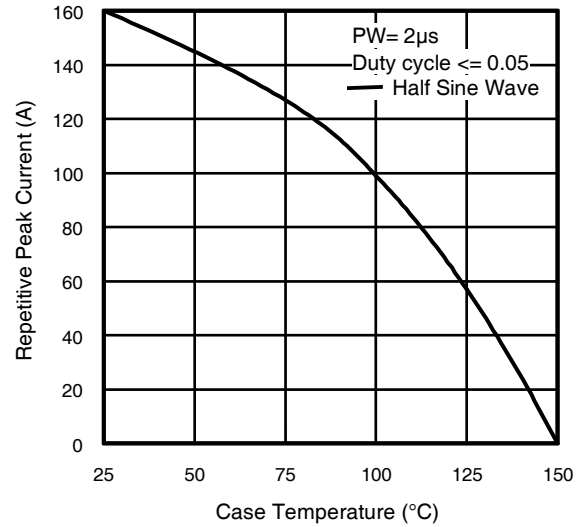

Fig 8. Typical Repetitive Peak Current vs. Case Temperature

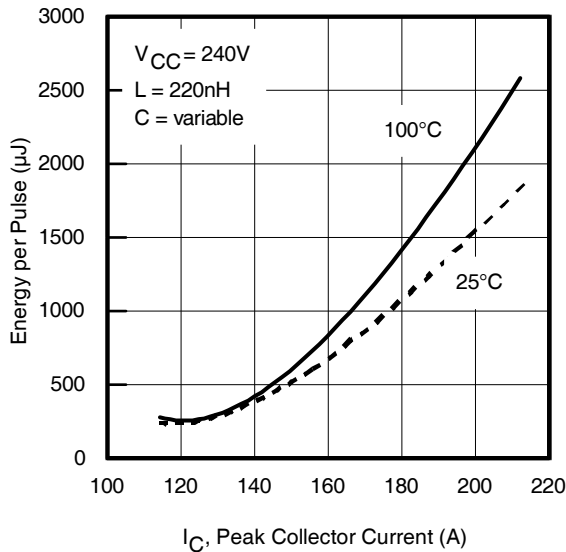

Fig 9. Typical E_{PULSE} vs. Collector Current

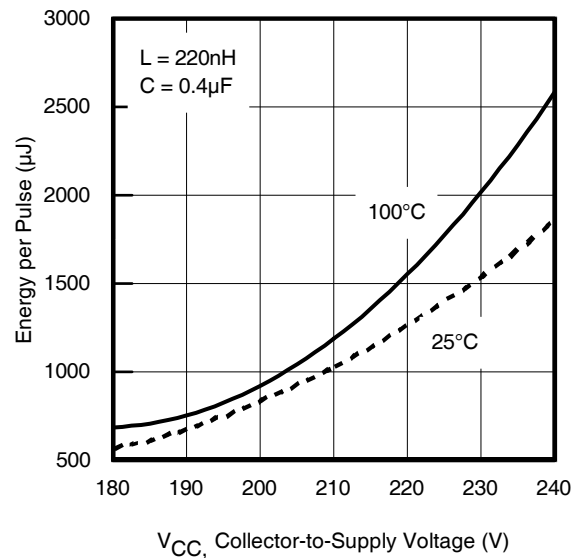

Fig 10. Typical E_{PULSE} vs. Collector-to-Supply Voltage

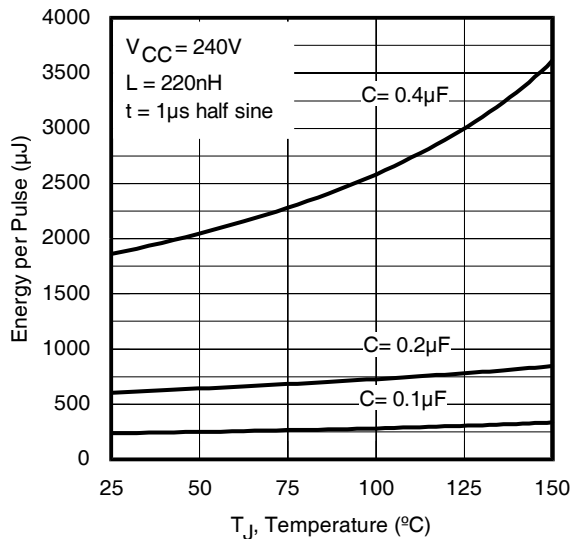

Fig 11. E_{PULSE} vs. Temperature

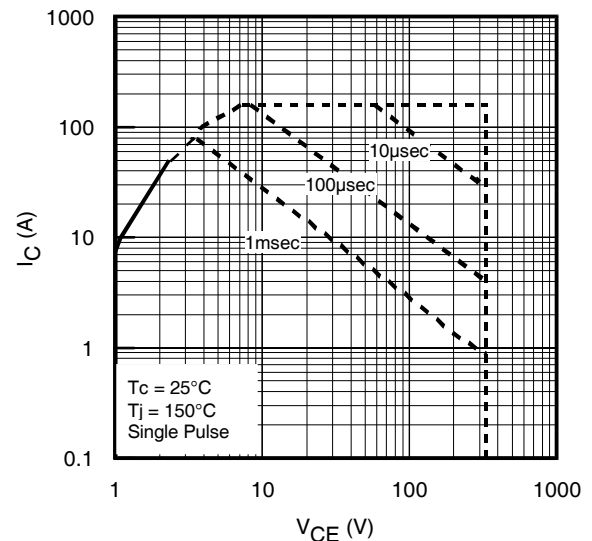

Fig 12. Forward Bias Safe Operating Area

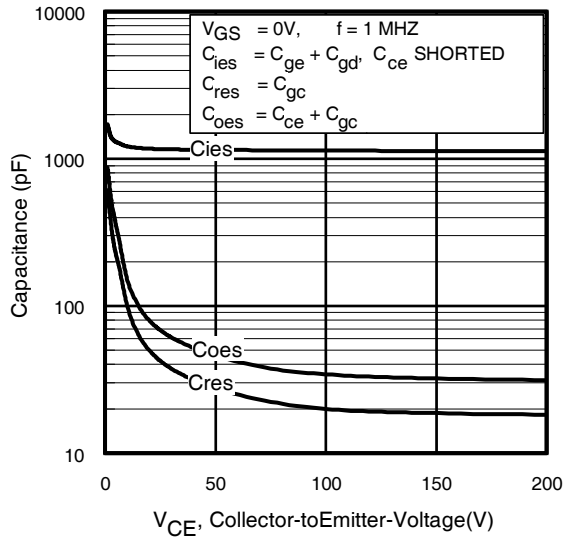

Fig 13. Typical Capacitance vs. Collector-to-Emitter Voltage

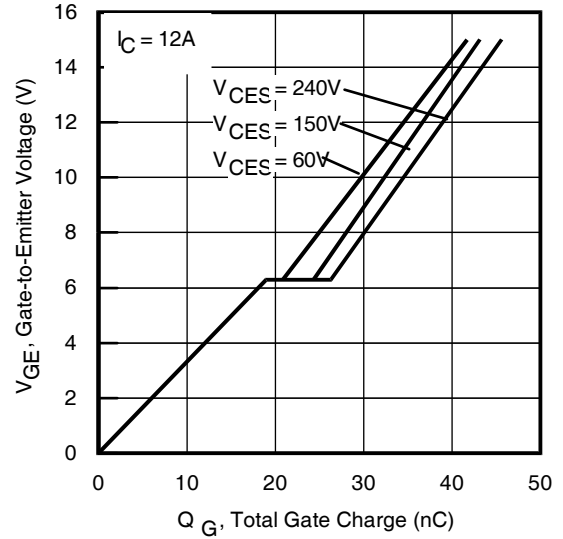

Fig 14. Typical Gate Charge vs. Gate-to-Emitter Voltage

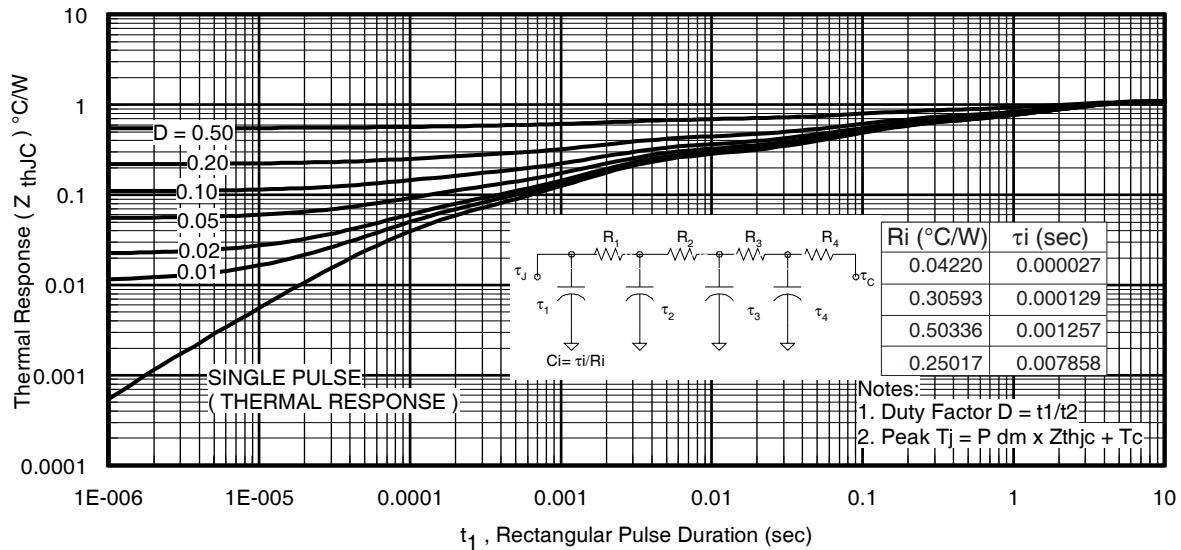

Fig 15. Maximum Effective Transient Thermal Impedance, Junction-to-Case

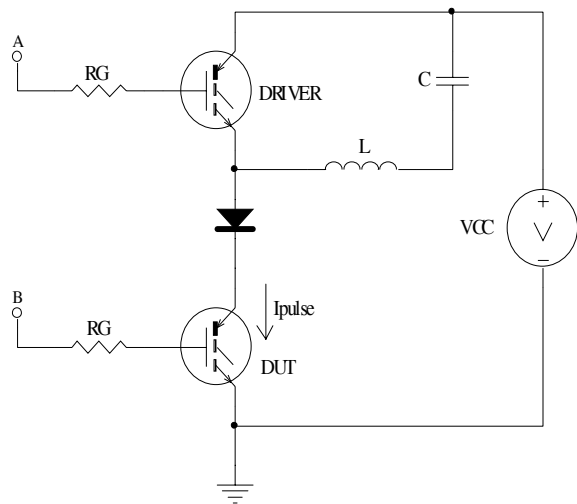

Fig 16a. t_{st} and E_{PULSE} Test Circuit

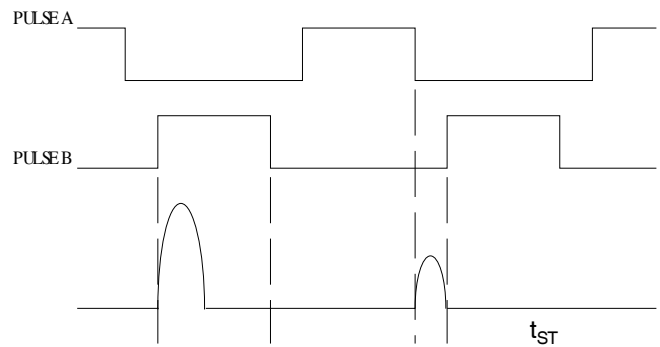

Fig 16b. t_{st} Test Waveforms

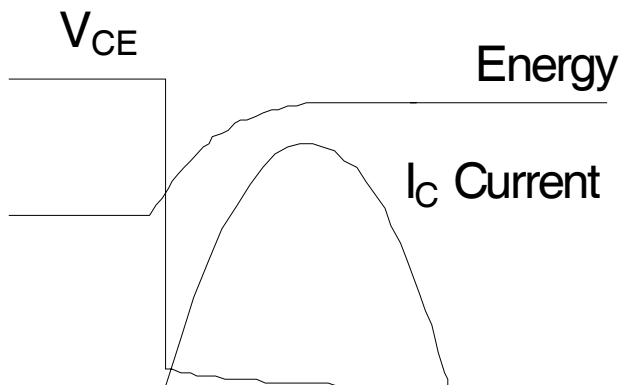

Fig 16c. E_{PULSE} Test Waveforms

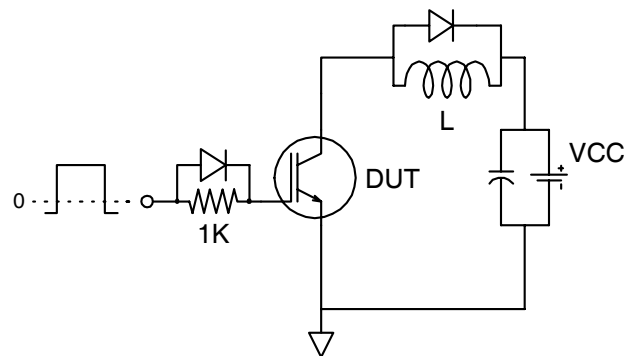
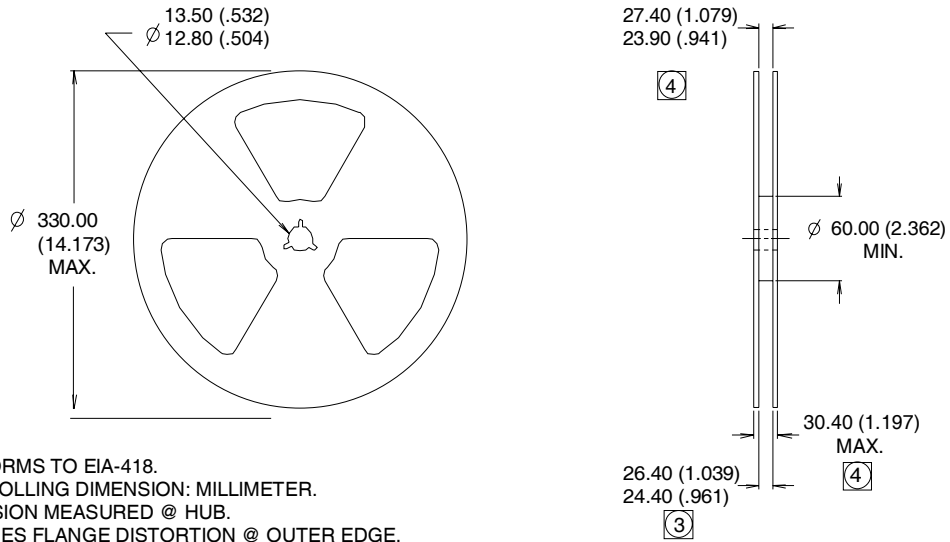
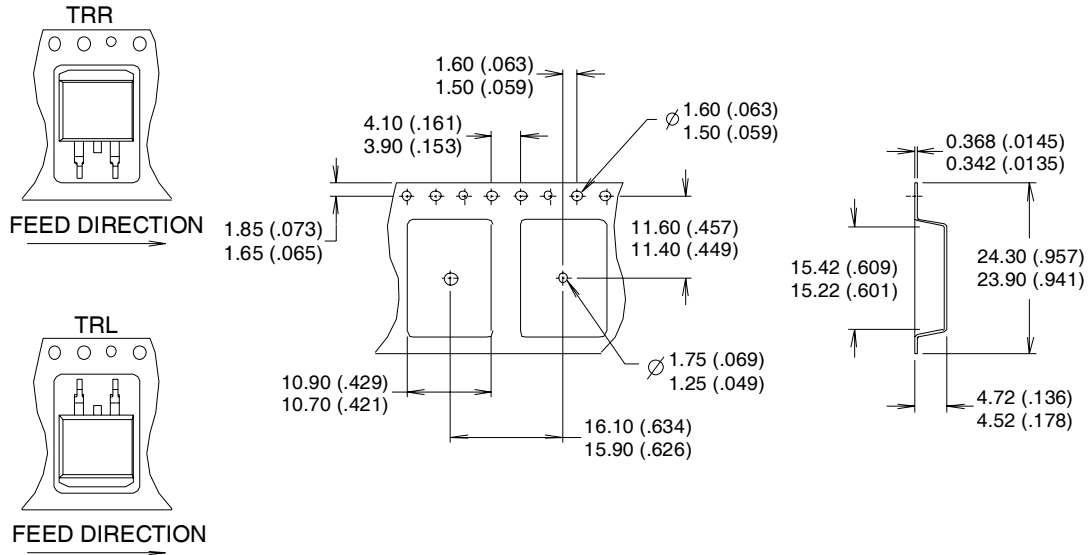

Fig 17 - Gate Charge Circuit (turn-off)

IRG6S320UPbF

D²Pak (TO-263AB) Tape & Reel Information

Dimensions are shown in millimeters (inches)



Note: For the most current drawing please refer to IR website at <http://www.irf.com/package/>

Data and specifications subject to change without notice.
This product has been designed for the Industrial market.
Qualification Standards can be found on IR's Web site.