

TINA2-R-CLIP16

Mini reflector with ~60° wide beam

TECHNICAL SPECIFICATIONS:

Dimensions	Ø 16.1 mm
Height	10.1 mm
Fastening	clips
Colour	clear
Box size	
Box weight	3.8 kg
Quantity in Box	pcs
ROHS compliant	yes ⓘ



MATERIAL SPECIFICATIONS:

Component	Type	Material	Colour	Coating
TINA2-R-CLIP16	Reflector	HRPC	clear	

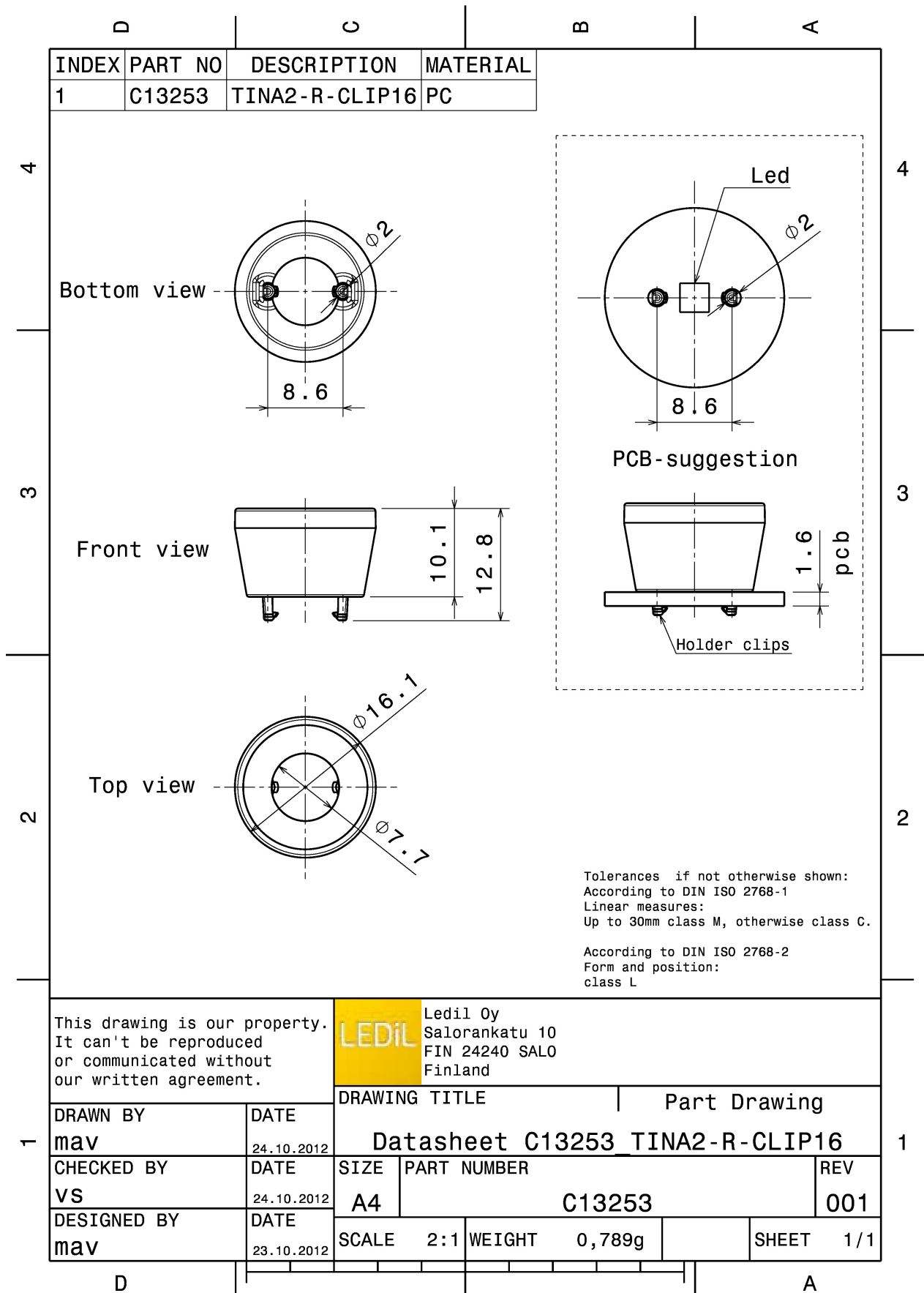

PHOTOMETRIC DATA (MEASURED):

CREE 

LED XB-D
FWHM 73.0°
Efficiency 90 %
Peak intensity 0.575 cd/lm
Required components:

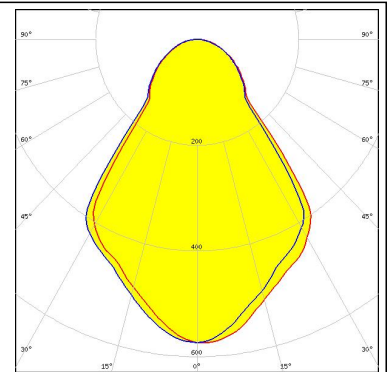

CREE 

LED XB-H
FWHM 81.0°
Efficiency 92 %
Peak intensity 0.460 cd/lm
Required components:

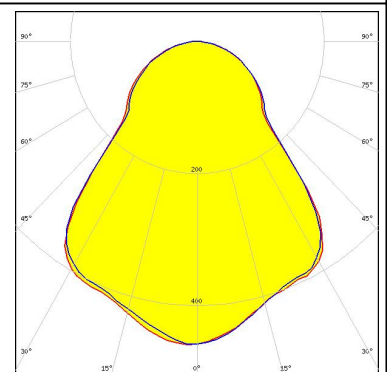
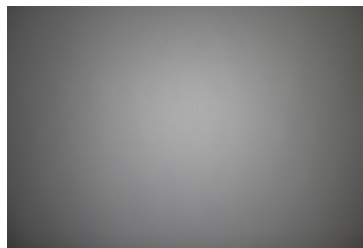

CREE 

LED XM-L
FWHM 78.0°
Efficiency 88 %
Peak intensity 0.480 cd/lm
Required components:

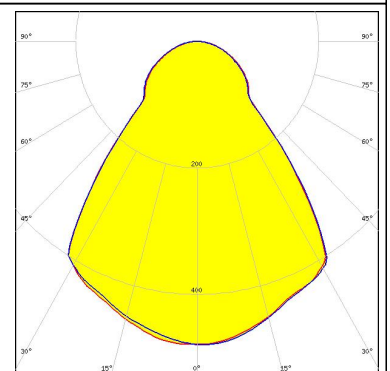
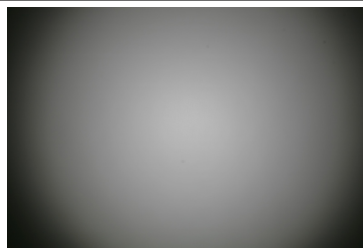

CREE 

LED XM-L2
FWHM 78.0°
Efficiency 90 %
Peak intensity 0.480 cd/lm
Required components:

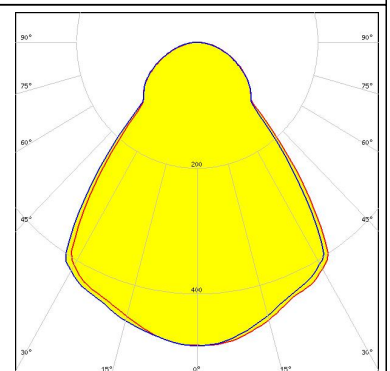
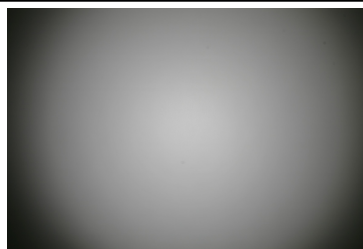

PHOTOMETRIC DATA (MEASURED):

CREE 

LED XP-E
FWHM 74.0°
Efficiency 90 %
Peak intensity 0.544 cd/lm
Required components:

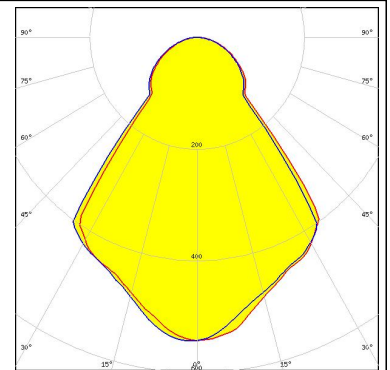

CREE 

LED XP-E2
FWHM 74.0°
Efficiency 90 %
Peak intensity 0.560 cd/lm
Required components:

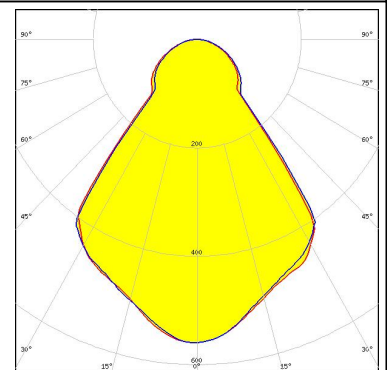
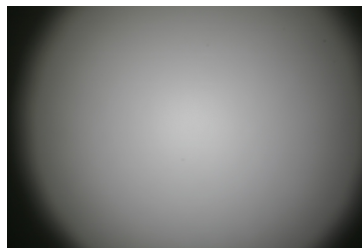

CREE 

LED XP-G
FWHM 77.0°
Efficiency 90 %
Peak intensity 0.506 cd/lm
Required components:

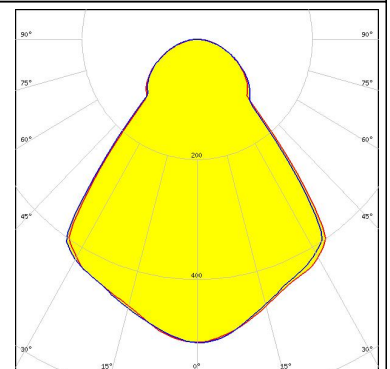
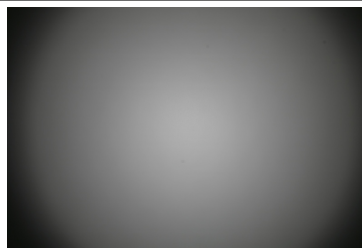

CREE 

LED XP-G2
FWHM 75.0°
Efficiency 89 %
Peak intensity 0.530 cd/lm
Required components:

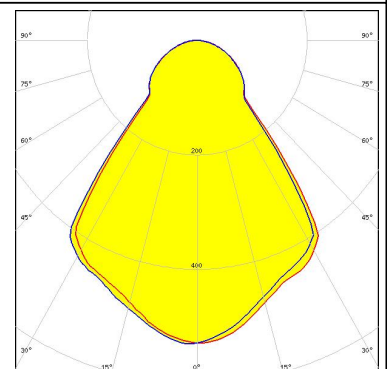
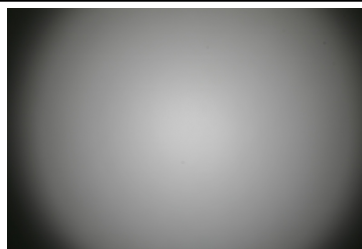

PHOTOMETRIC DATA (MEASURED):



LED XT-E
FWHM 71.0°
Efficiency 87 %
Peak intensity 0.585 cd/lm
Required components:

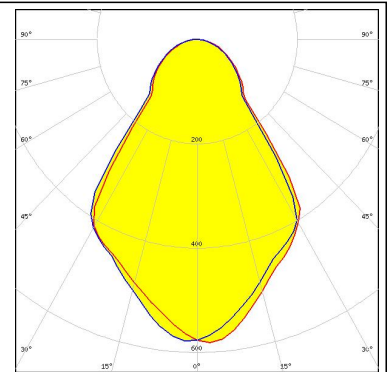

LED LUXEON A
FWHM 75.0°
Efficiency 91 %
Peak intensity 0.540 cd/lm
Required components:

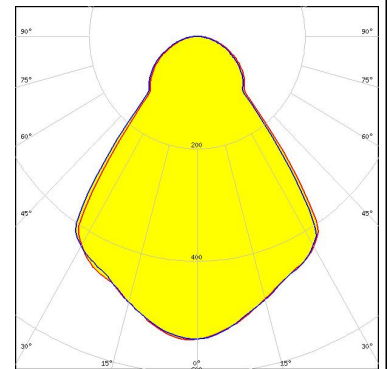
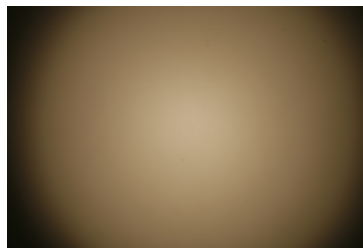

LED LUXEON R
FWHM 75.0°
Efficiency 89 %
Peak intensity 0.550 cd/lm
Required components:

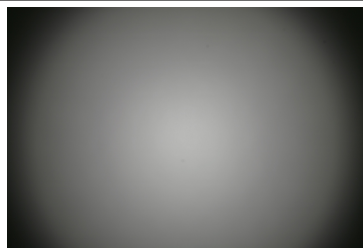

LED LUXEON Rebel
FWHM 72.0°
Efficiency 90 %
Peak intensity 0.607 cd/lm
Required components:

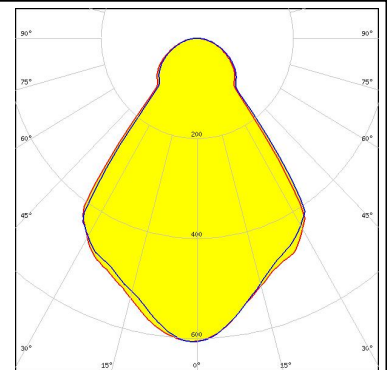

PHOTOMETRIC DATA (MEASURED):

LUMILEDS

LED LUXEON Rebel ES
FWHM 74.0°
Efficiency 89 %
Peak intensity 0.550 cd/lm
Required components:

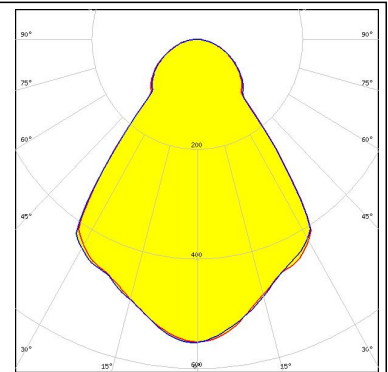

LUMILEDS

LED LUXEON T
FWHM 75.0°
Efficiency 89 %
Peak intensity 0.535 cd/lm
Required components:

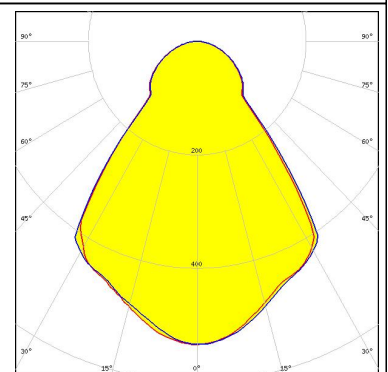
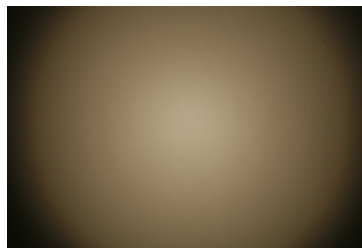

LUMILEDS

LED LUXEON TX
FWHM 81.0°
Efficiency 90 %
Peak intensity 0.500 cd/lm
Required components:

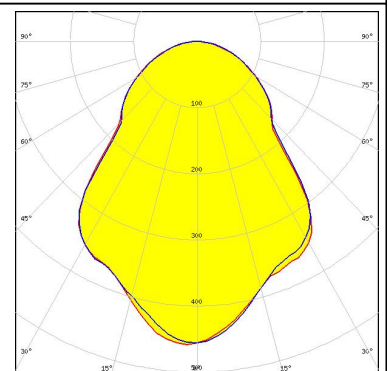
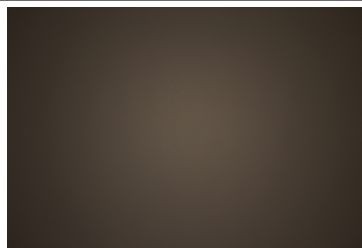

NICHIA

LED NCSxx19A
FWHM 72.0°
Efficiency 90 %
Peak intensity 0.600 cd/lm
Required components:

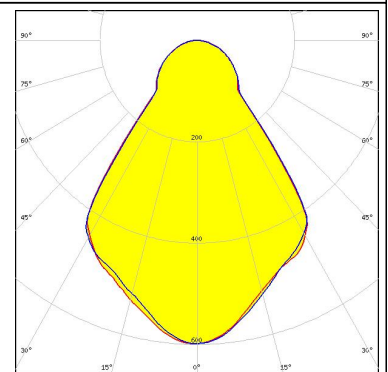
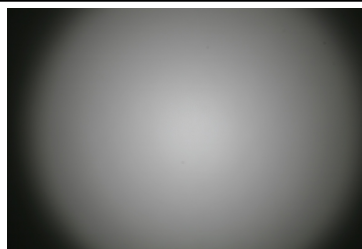

PHOTOMETRIC DATA (MEASURED):



LED NF2x757A
FWHM 72.0°
Efficiency 92 %
Peak intensity 0.595 cd/lm
Required components:

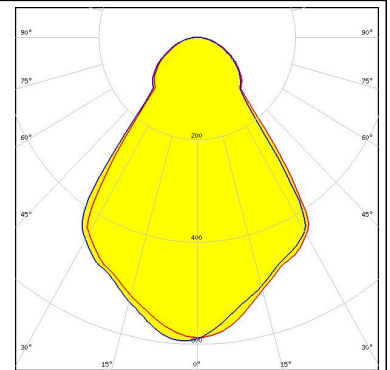

LED NVSxx19A
FWHM 74.0°
Efficiency 90 %
Peak intensity 0.556 cd/lm
Required components:

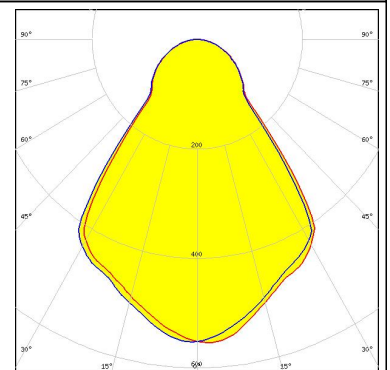
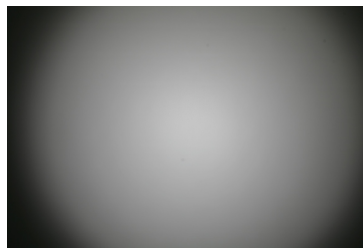



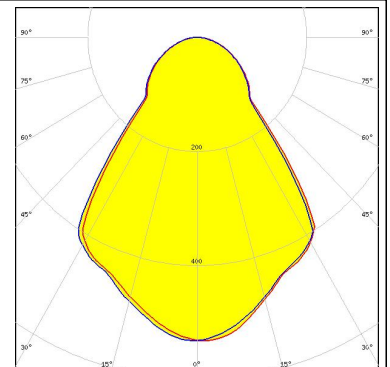

LED NVSxx19B/NVSxx19C
FWHM 74.0°
Efficiency 89 %
Peak intensity 0.534 cd/lm
Required components:

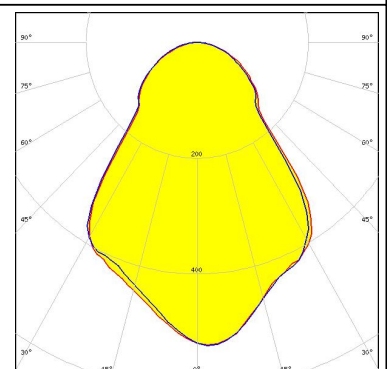
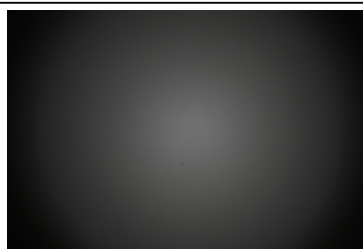

LED Duris S5 (2 chip)
FWHM 76.0°
Efficiency 91 %
Peak intensity 0.500 cd/lm
Required components:

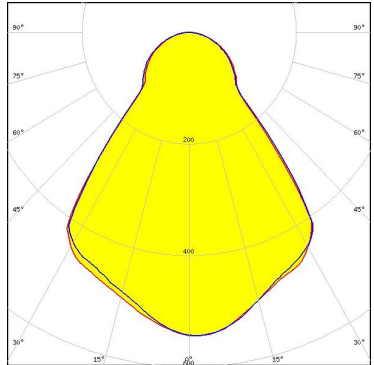
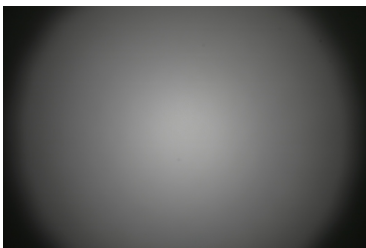
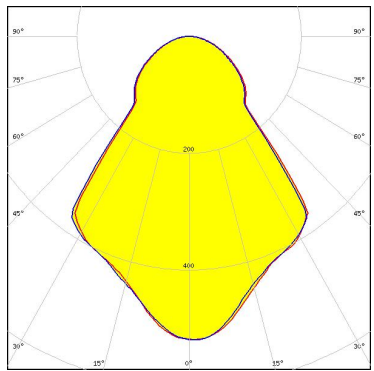

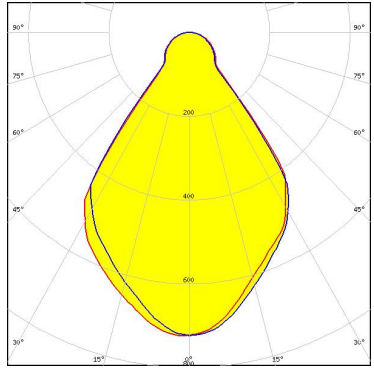
PHOTOMETRIC DATA (MEASURED):

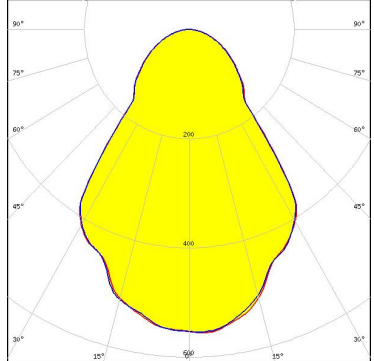
<p>OSRAM Opto Semiconductors</p> <p>LED Oslon Square EC FWHM 75.0° Efficiency 91 % Peak intensity 0.545 cd/lm Required components:</p>		
<p>OSRAM Opto Semiconductors</p> <p>LED Oslon SSL 150 FWHM 75.0° Efficiency 88 % Peak intensity 0.520 cd/lm Required components:</p>		
<p>OSRAM Opto Semiconductors</p> <p>LED Oslon SSL 80 FWHM 71.0° Efficiency 91 % Peak intensity 0.725 cd/lm Required components:</p>		
<p>SEOUL SEMICONDUCTOR</p> <p>LED Z8Y15 FWHM 72.0° Efficiency 90 % Peak intensity 0.557 cd/lm Required components:</p>		

PHOTOMETRIC DATA (MEASURED):

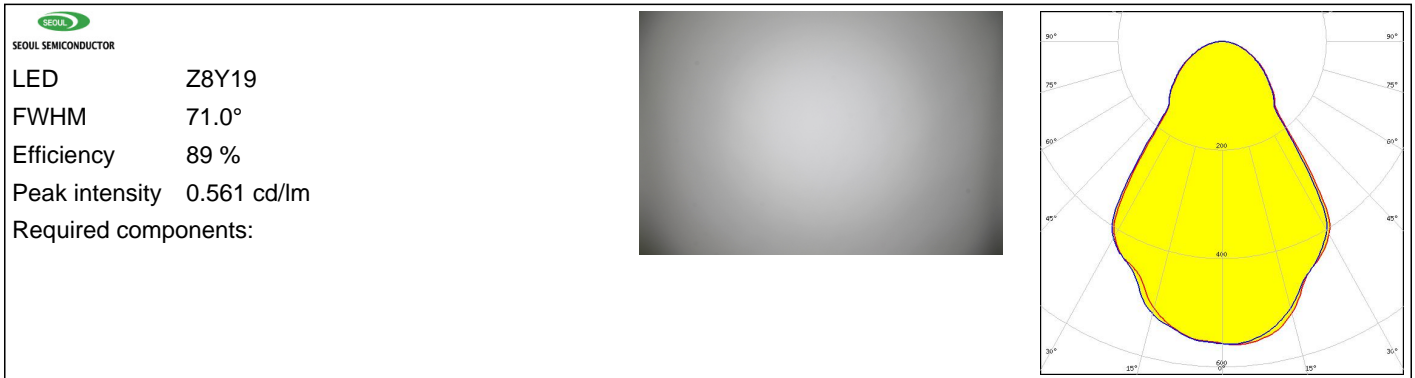

PHOTOMETRIC DATA (SIMULATED):

OSRAM
Opto Semiconductors

LED Oslon Black

FWHM 71.0°

Efficiency 80 %

Peak intensity 0.600 cd/lm

Required components:

Undefined Manufacturer: Protective Plate, Glass

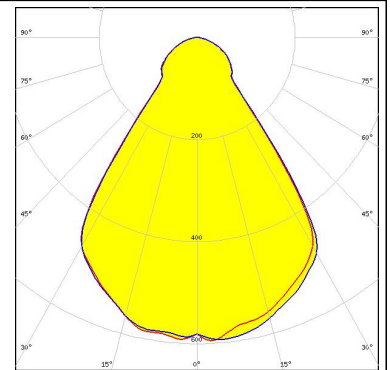

OSRAM
Opto Semiconductors

LED Oslon Square Gen3

FWHM 65.0°

Efficiency 94 %

Peak intensity 0.677 cd/lm

Required components:

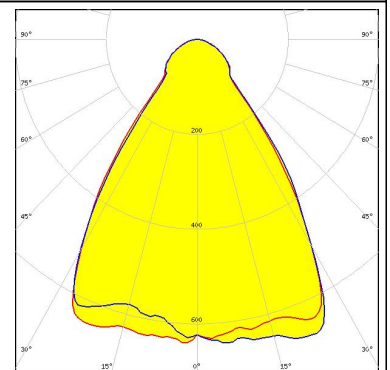

GENERAL INFORMATION:

NOTE: The typical beam angle will be changed by different color, chip size and chip position tolerance. The typical total beam angle is the full angle measured where the luminous intensity is half of the peak value.

MATERIALS:

As part of our continuous research and improvement processes, and to ensure the best possible quality and availability of our products, LEDiL reserves the right to change material grades without notice.

PRODUCT DATA USER AGREEMENT AND DISCLAIMER:

The measured data in the provided downloadable LEDiL Product Datasheets and Mechanical 2D-Drawings is rounded and provided as reference for planning. LEDiL Oy's optical specifications have been verified by conducting performance testing of the products in accordance with the company's quality system. The reported data are averaged results of multiple measurements with typical variation. LEDiL Oy reserves the right to without prior notification make changes and improvements to its products.

LEDiL Oy assumes neither warranty, nor guarantee nor any other liability of any kind for the contents and correctness of the provided data. The provided data has been generated with highest diligence but the provided data may in reality not represent the complete possible variation range of all intrinsic parameters. Therefore, in certain cases a deviation from the provided data could occur.

LEDiL Oy reserves the right to undertake technical changes of its products without further notification which could lead to changes in the provided data. LEDiL Oy assumes no liability of any kind for the possible deviation from any provided data or any other damage resulting from the usage of the provided data.

The user agrees to this disclaimer and user agreement with the download or usage of the provided files.

LEDiL Oy

Joensuunkatu 13
FI-24240 SALO
Finland

LEDiL Inc.

228 West Page Street
Suite D
Sycamore IL 60178
USA

Local sales and technical support

[www.ledil.com/
where_to_buy](http://www.ledil.com/where_to_buy)

Shipping locations

Salo, Finland
Hong Kong, China

Distribution Partners

[www.ledil.com/
where_to_buy](http://www.ledil.com/where_to_buy)