



Quick Start Guide

UM QS EN PROFINET STARTERKIT 3

Order No.: —

Installing and starting up the
PROFINET starter kit 3.0

AUTOMATION

Quick Start Guide

Installing and starting up the PROFINET starter kit 3.0

02/2009

Designation: UM QS EN PROFINET STARTERKIT 3

Revision: 00

Order No.: —

This user manual is valid for:

Designation	Version	Order No.
PROFINET starter kit 3.0	3.0	2988395

Please observe the following notes

In order to ensure the safe use of the product described, you have to read and understand this manual. The following notes provide information on how to use this manual.

User group of this manual

The use of products described in this manual is oriented exclusively to

- qualified electricians or persons instructed by them, who are familiar with applicable standards and other regulations regarding electrical engineering and, in particular, the relevant safety concepts.
- qualified application programmers and software engineers, who are familiar with the safety concepts of automation technology and applicable standards.

Phoenix Contact accepts no liability for erroneous handling or damage to products from Phoenix Contact or third-party products resulting from disregard of information contained in this manual.

Explanation of symbols used and signal words



This is the safety alert symbol. It is used to alert you to potential personal injury hazards. Obey all safety messages that follow this symbol to avoid possible injury or death.



DANGER

This indicates a hazardous situation which, if not avoided, will result in death or serious injury.



WARNING

This indicates a hazardous situation which, if not avoided, could result in death or serious injury.



CAUTION

This indicates a hazardous situation which, if not avoided, could result in minor or moderate injury.

The following types of messages provide information about possible property damage and general information concerning proper operation and ease-of-use.



NOTE

This symbol and the accompanying text alerts the reader to a situation which may cause damage or malfunction to the device, either hardware or software, or surrounding property.



This symbol and the accompanying text provides additional information to the reader. It is also used as a reference to other sources of information (manuals, data sheets, literature) on the subject matter, product, etc.

General terms and conditions of use for technical documentation

Phoenix Contact reserves the right to alter, correct, and/or improve the technical documentation and the products described in the technical documentation at its own discretion and without giving prior notice, insofar as this is reasonable for the user. The same applies to any technical changes that serve the purpose of technical progress.

The receipt of technical documentation (in particular data sheets, installation instructions, manuals, etc.) does not constitute any further duty on the part of Phoenix Contact to furnish information on alterations to products and/or technical documentation. Any other agreement shall only apply if expressly confirmed in writing by Phoenix Contact. Please note that the supplied documentation is product-specific documentation only and that you are responsible for checking the suitability and intended use of the products in your specific application, in particular with regard to observing the applicable standards and regulations. Although Phoenix Contact makes every effort to ensure that the information content is accurate, up-to-date, and state-of-the-art, technical inaccuracies and/or printing errors in the information cannot be ruled out. Phoenix Contact does not offer any guarantees as to the reliability, accuracy or completeness of the information. All information made available in the technical data is supplied without any accompanying guarantee, whether expressly mentioned, implied or tacitly assumed. This information does not include any guarantees regarding quality, does not describe any fair marketable quality, and does not make any claims as to quality guarantees or guarantees regarding the suitability for a special purpose.

Phoenix Contact accepts no liability or responsibility for errors or omissions in the content of the technical documentation (in particular data sheets, installation instructions, manuals, etc.).

The aforementioned limitations of liability and exemptions from liability do not apply, in so far as liability must be assumed, e.g., according to product liability law, in cases of premeditation, gross negligence, on account of loss of life, physical injury or damage to health or on account of the violation of important contractual obligations. Claims for damages for the violation of important contractual obligations are, however, limited to contract-typical, predictable damages, provided there is no premeditation or gross negligence, or that liability is assumed on account of loss of life, physical injury or damage to health. This ruling does not imply a change in the burden of proof to the detriment of the user.

Statement of legal authority

This manual, including all illustrations contained herein, is copyright protected. Use of this manual by any third party is forbidden. Reproduction, translation, and public disclosure, as well as electronic and photographic archiving or alteration requires the express written consent of Phoenix Contact. Violators are liable for damages.

Phoenix Contact reserves all rights in the case of patent award or listing of a registered design, in as far as this concerns software of Phoenix Contact that meets the criteria of technicality or has technical relevance. Third-party products are always named without reference to patent rights. The existence of such rights shall not be excluded.

Windows 3.x, Windows 95, Windows 98, Windows NT, Windows 2000, Windows XP, and Windows Vista are trademarks of the Microsoft Corporation.

All other product names used are trademarks of the respective organizations.

How to contact us

Internet

Up-to-date information on Phoenix Contact products and our Terms and Conditions can be found on the Internet at:

www.phoenixcontact.com.

Make sure you always use the latest documentation.

It can be downloaded at:

www.phoenixcontact.com.

Subsidiaries

If there are any problems that cannot be solved using the documentation, please contact your Phoenix Contact subsidiary.

Subsidiary contact information is available at www.phoenixcontact.com.

Published by

PHOENIX CONTACT GmbH & Co. KG
Flachmarktstraße 8
32825 Blomberg
Germany
Phone +49 - (0) 52 35 - 3-00
Fax +49 - (0) 52 35 - 3-4 12 00

PHOENIX CONTACT
P.O. Box 4100
Harrisburg, PA 17111-0100
USA
Phone +1-717-944-1300

Should you have any suggestions or recommendations for improvement of the contents and layout of our manuals, please send your comments to

tecdoc@phoenixcontact.com.

Table of contents

1	General.....	1-3
1.1	Introduction.....	1-3
1.2	Information about this document	1-3
1.3	PROFINET starter kit 3.0 components	1-4
1.4	System requirements for the PC WorX programming software version 5.20 service pack 3 or later.....	1-5
1.4.1	Supported operating systems	1-5
1.4.2	Hardware and software requirements	1-5
1.4.3	Firmware version requirements	1-5
2	Installing hardware.....	2-1
3	Installing and enabling the PC WorX 5 software	3-1
3.1	Installing software.....	3-1
3.1.1	Prior to installation	3-1
3.1.2	Starting the installation program	3-1
3.1.3	Starting PC WorX	3-2
3.2	Enabling the PC WorX license.....	3-2
4	Helpful information about PC WorX	4-1
4.1	Online help	4-1
4.2	The PC WorX user interface	4-1
4.3	Toolbars	4-2
4.4	Workspaces	4-3
4.5	"Bus Structure" window	4-7
4.5.1	Icons in the "Bus Structure" window	4-7
4.5.2	Display in the "Bus Structure" window	4-10
4.6	Compiling and transmitting projects, and performing a cold restart	4-12
5	Example project.....	5-1
5.1	Overview	5-1
5.2	Creating a new project.....	5-2
5.3	Adapting the project information	5-3
5.4	Preparing the PC for communication	5-5
5.5	Checking/modifying the IP settings for the PROFINET IO controller.....	5-6
5.6	Assigning the IP address for the PROFINET IO controller	5-7
5.6.1	Address assignment via the PC WorX BootP server	5-7
5.6.2	Address assignment with PC WorX via the serial interface	5-9
5.7	Reading PROFINET IO devices	5-11
5.8	Checking/modifying the PROFINET settings for PROFINET IO devices	5-14

5.9	Transmitting PROFINET device names and IP settings to PROFINET IO devices.....	5-16
5.10	Reading the connected bus.....	5-17
5.11	Compiling and sending a project, and performing a cold restart after reading the bus topology	5-20
5.12	Programming an example program including variable creation	5-21
5.13	Compiling after creating the program.....	5-23
5.14	Assigning process data	5-24
5.15	Compiling and sending a project (including program), and performing a cold restart.....	5-25
5.16	Operation and debug mode.....	5-26
5.17	Example project on CD.....	5-28
6	Additional functions of PC WorX.....	6-1
6.1	Modifying the PROFINET device name	6-1
6.2	Renumbering devices.....	6-4
6.3	Diagnostics with Diag+	6-5
6.4	Importing Ethernet devices into the project.....	6-12
6.5	Detecting Ethernet topologies	6-14
6.6	Device description files.....	6-19
6.6.1	Phoenix Contact device description files	6-19
6.6.2	Device description files from other manufacturers (GSD files)	6-20
A	Appendix: Status information and system variables.....	A-1
A 1	Configuration status of the PROFINET IO controller.....	A-1
A 2	Status of a PROFINET IO device.....	A-2
A 3	PNIO_FORCE_FAILSAFE system variable.....	A-3

1 General

1.1 Introduction

The PROFINET starter kit 3.0 is a combination of hardware and software. It contains all the components you need in order to create and start up a basic PROFINET IO system.

1.2 Information about this document

Using an example project, this document helps you to install and parameterize a bus configuration and to program the application program (according to IEC 61131).

It is assumed the user has knowledge and experience in the operation of PCs and Windows® operating systems, and knowledge in IEC 61131.



For more detailed information about the hardware components, please refer to the documentation for the components. The documentation is also included on the CD supplied with the PROFINET starter kit 3.0. Moreover, the documentation can be downloaded at www.phoenixcontact.net/download.

More detailed information about the individual functions of PC WorX can be found in the online help for the program. The entire help function can be called via "Help" in the menu bar. Help for specific functions can be called via F1.



This manual describes the quickest way to start up. Since the devices are read, a complete physical bus configuration is required.

No functions or commands that require communication with the control system can be executed without a physical bus configuration. However, complete parameterization is possible in the "offline" state. The application program can also be created and compiled. Should you wish to proceed in this way, please refer to the Quick Start Guide for PC WorX.

1.3 PROFINET starter kit 3.0 components

Table 1-1 PROFINET starter kit 3.0 components

Description	Type	Order No.	Number
Software			
PC WorX programming software	PC WORX version 5.20 SP 3 or later	See AUTOMATION catalog from Phoenix Contact	
Hardware (modules)			
Inline controller	ILC 350 PN	2876928	1
Smart Managed Compact Switch with eight ports in RJ45 format	FL SWITCH SMCS 8TX	2891123	1
PROFINET IO bus coupler	IL PN BK DI8 DO4 2TX-PAC	2703994	1
Inline terminal with 4 digital outputs	IB IL 24 DO 4-ME	2863931	1
Inline terminal with 4 digital inputs	IB IL 24 DI 4-ME	2863928	1
Hardware (accessories, part of the starter kit)			
Parameterization memory	IBS CF FLASH 256MB	2888780	1
Programming cable	PRG CAB MINI DIN	2730611	1
Ethernet patch cable (5 pcs.)	FL CAT5 PATCH 1.0	2832276	1
Power supply unit	STEP-PS-100-240AC/24DC/1.5	2938947	1
Toggle switch (pre-assembled)	SCHALTER KIPP-KONFEKTIONIERT	9149195	2
Double terminal block for DIN rail, gray	UDK 4	2775016	1
Cover for double terminal block, gray	D-UDK 4	2775113	1
Double terminal block for DIN rail, blue	UDK 4 BU	2775090	1
Cover for double terminal block, blue	D-UDK 4 BU	2775197	1
Documentation			
Quick start guide	UM QS EN PROFINET STARTERKIT 3.0	—	1

Table 1-2 Accessories (not included in the PROFINET starter kit 3.0)

Description	Type	Order No.
Standard end clamp	CLIPFIX 35-5	3022276
Spring-cage ground terminal block	ST 4-PE	3031380
Cover for spring-cage ground terminal block	D-ST 4	3030420
"Installing and starting up the PROFINET starter kit 3.0t" quick start guide	UM QS EN PROFINET STARTERKIT 3.0	—

1.4 System requirements for the PC WorX programming software version 5.20 service pack 3 or later

1.4.1 Supported operating systems

- Windows® 2000
- Windows® XP (recommended)
- Windows® Vista

1.4.2 Hardware and software requirements

The hardware and software required to operate PC WorX can be found in the "? , PLC Help" menu under "Programming System Help, System requirements".

Minimum System Requirements	Windows XP	Windows 2000	Windows NT/SP 6
CPU	800 MHz	800 MHz	1 GHz
Main memory	256 MB RAM	256 MB RAM	256 MB RAM
Hard-disk-storage	400 MB	400 MB	400 MB
Monitor (resolution)	SVGA (800 x 600)	SVGA (800 x 600)	SVGA (800 x 600)
Mouse	X	X	X
CD-ROM drive	X	X	X
Internet Explorer 5.5 or higher	X	X	X

Recommended System Requirements	Windows XP / Windows 2000
CPU	1 GHz
Main memory	256 MB RAM
Hard-disk-storage	400 MB
Monitor (resolution)	XGA (1024 x 768)
Mouse	X
CD-ROM drive	X
Internet Explorer 5.5 or higher	X

Figure 1-1 Hardware and software requirements

1.4.3 Firmware version requirements

Table 1-3 Firmware version requirements

Device	Firmware version
ILC 350 PN	≥ 2.00
IL PN BK DI8 DO4 2TX-PAC	≥ 2.00
FL SWITCH SMCS 8TX	≥ 2.20



If the firmware version on your device is earlier than that specified in Table 1-3, please update your firmware. The latest firmware version can be downloaded at www.phoenixcontact.net/download.

2 Installing hardware

One possible installation method is shown in Figure 2-1.

- Please mount all PROFINET IO components and the corresponding accessories on DIN rails. To do so, proceed as described in the corresponding package slips.

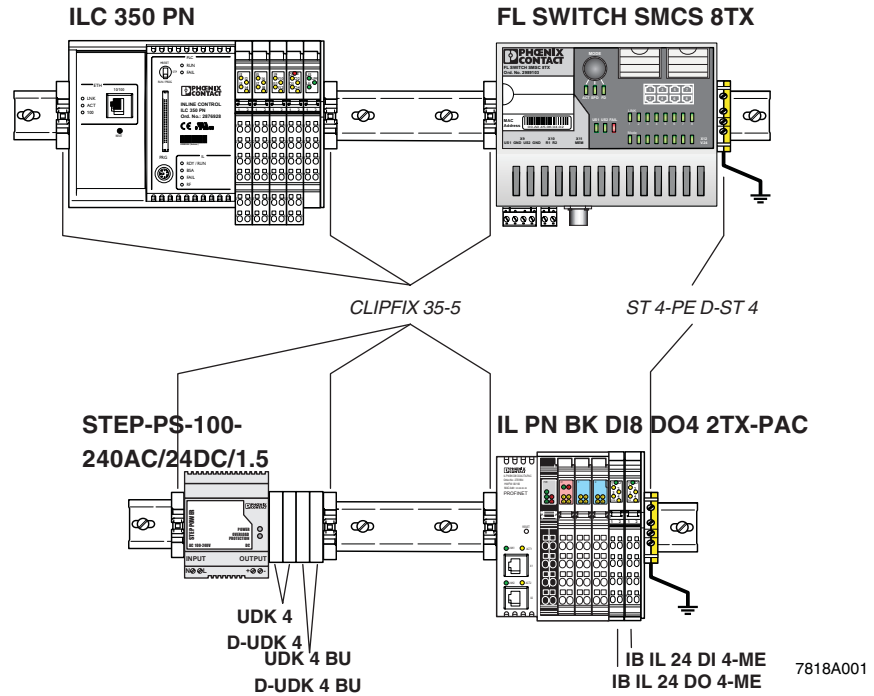

Figure 2-1 Possible installation method for the PROFINET starter kit 3.0

Key:

- Bold** Part of the starter kit
- Italic* Order as accessories

- Connect the supply voltage cables.

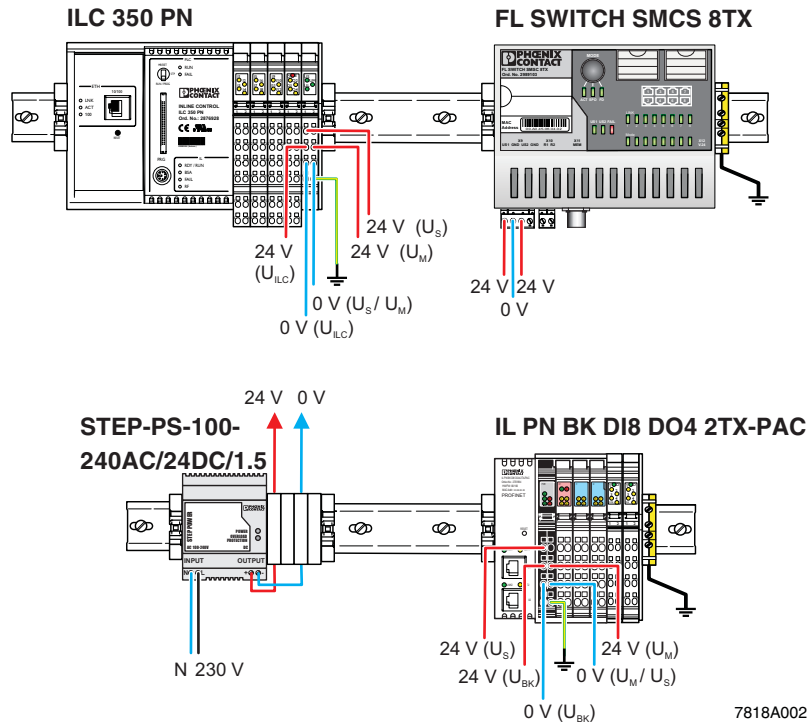

Figure 2-2 Possible installation of the PROFINET starter kit 3.0 - Illustration with supply voltage wiring

7818A002

- Connect the I/O devices. The PROFINET starter kit 3.0 also contains two pre-assembled toggle switches. Connect them to the I/O connectors. To do so, proceed as described in the package slip for the module.

For the example program in this documentation, the following inputs and outputs are used:

Table 2-1 Inputs and outputs used in the example

Device	Input/output	Signal at	Variable
ILC 350 PN	Input I11	Connector 3 terminal point 1.4	ONBOARD_INPUT_BIT10
IB IL 24 DI 4-ME	Input I1	Terminal point 1.1	IN2
IL PN BK DI8 DO4 2TX-PAC	Output O7	Connector 4 terminal point 1.4	OUT

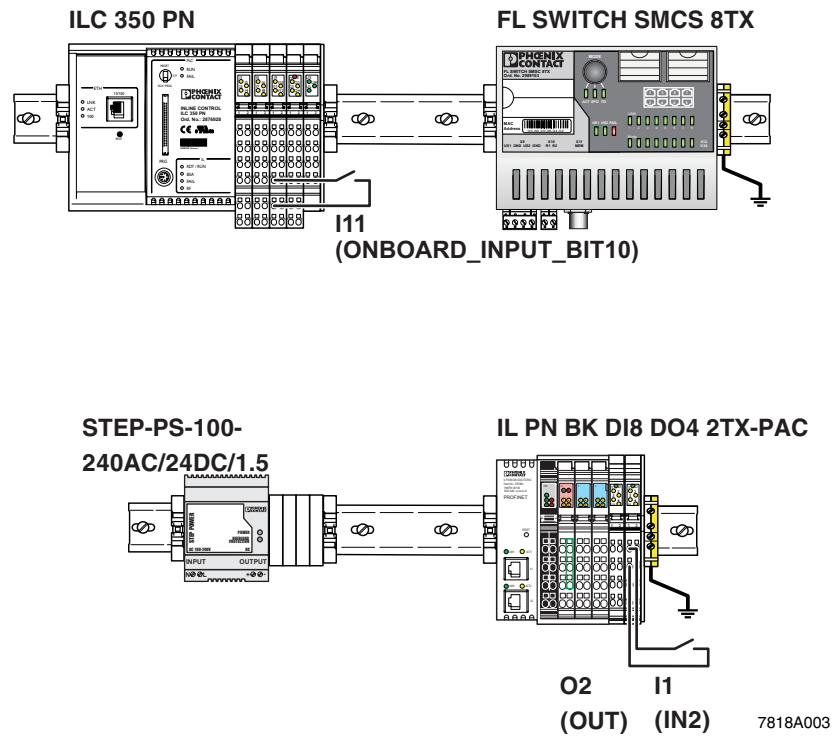
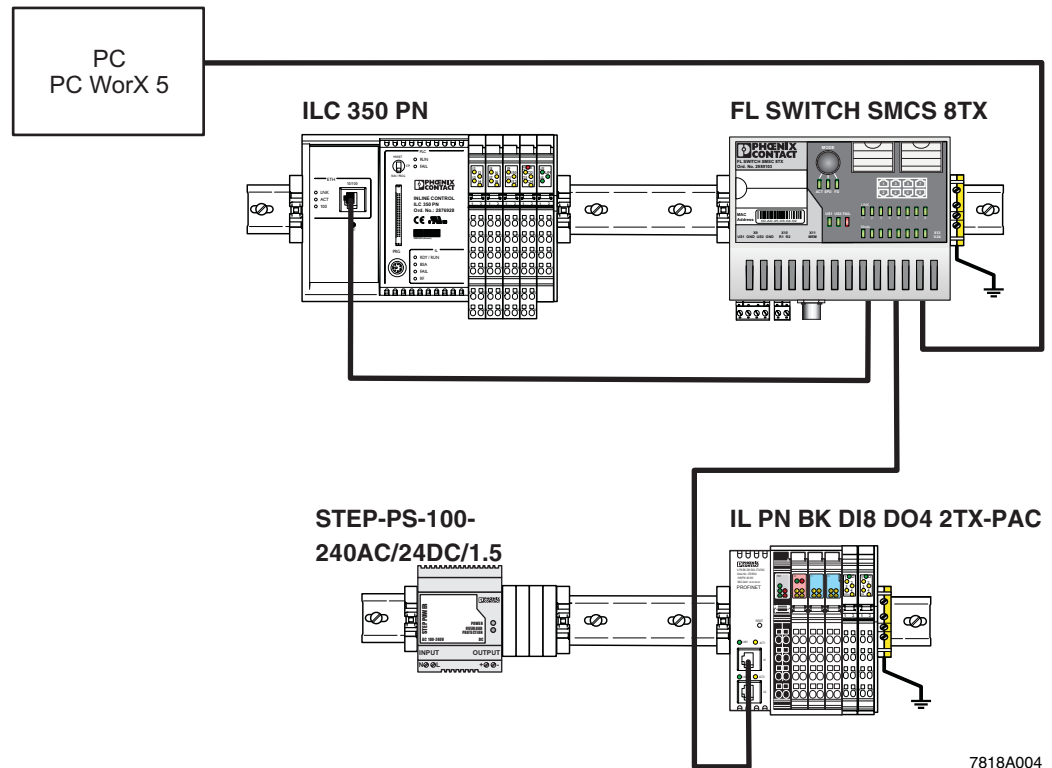

Figure 2-3 Possible installation of the PROFINET starter kit 3.0 - Illustration with input and output wiring

7818A003

PROFINET starter kit 3.0

- Connect the Ethernet cables.



7818A004

Figure 2-4 Possible installation of the PROFINET starter kit 3.0 - Illustration with Ethernet cabling

- Switch on the supply voltage.

3 Installing and enabling the PC WorX 5 software

3.1 Installing software

3.1.1 Prior to installation



Prior to installation, close all open Windows® applications.



NOTE:

If there already is a version of PC WorX on the PC on which PC WorX 5 is to be installed, please uninstall it before installing the new version.

3.1.2 Starting the installation program

Usually, the installation program will start automatically a few seconds after you place the CD-ROM in the CD drive.

- If it does not, start the "SETUP.EXE" file from the "[Drive]:\SETUP\" directory on the CD-ROM. This file calls the installation wizard, which guides you through the installation process.
- Follow the instructions in the installation program.

Automatic management of VAR_EXTERNAL

During installation you can select automatic management of VAR_EXTERNAL declarations.

By activating the checkbox you disable use of VAR_EXTERNAL declarations. PC WorX does the complete management of VAR_EXTERNAL. Please note, that when this option is enabled you cannot use VAR_EXTERNAL_PG and VAR_EXTERNAL_FB.

The compiler times increase when this option is enabled.

After having started PC WorX you may change the option via the "Extras/Options/General/Hide external variables" menu.

The installation program will generate all the directories necessary for operation and will copy the files according to your selection in the installation program.

- Following successful installation, restart your PC to apply the changes to the configuration files. To do this, click "Finish" at the end of the installation process.

3.1.3 Starting PC WorX

- For installation using the default settings, start PC WorX via "Start, All programs, Phoenix Contact... AUTOMATIONWORX Software Suite... PC WorX ...".

Valid versions for working with the PROFINET starter kit 3.0:

AUTOMATIONWORX Software Suite	2008 V1.40 or later
PC WorX	5.20 SP 3 or later



When started for the first time, PC WorX 5 runs in demo mode with limited resources. For the example project in this manual DEMO mode is sufficient.

If you wish to switch from demo mode to the full version, enable your PC WorX license.

3.2 Enabling the PC WorX license

After starting PC WorX, proceed as follows to enable your PC WorX license:

- Select the "Register..." command from the "?" menu.
- Enter your registration code.

The registration code for this starter kit version of PC WorX 5 is

1DC98-E7798-CFC06-06D0A-63F31-11A3E-EA6.

- Confirm your entry with OK.

Registration will come into effect when PC WorX is started again.

4 Helpful information about PC WorX

4.1 Online help

More detailed information about the individual functions of PROFINET starter kit 3.0 can be found in the online help for the program. The entire help function can be called via "Help" in the menu bar. Help for specific functions can be called via F1.

4.2 The PC WorX user interface

The user interface consists of the following main components: menu bar, toolbars, main window, and status bar. The contents of the main window depend on the workspace.

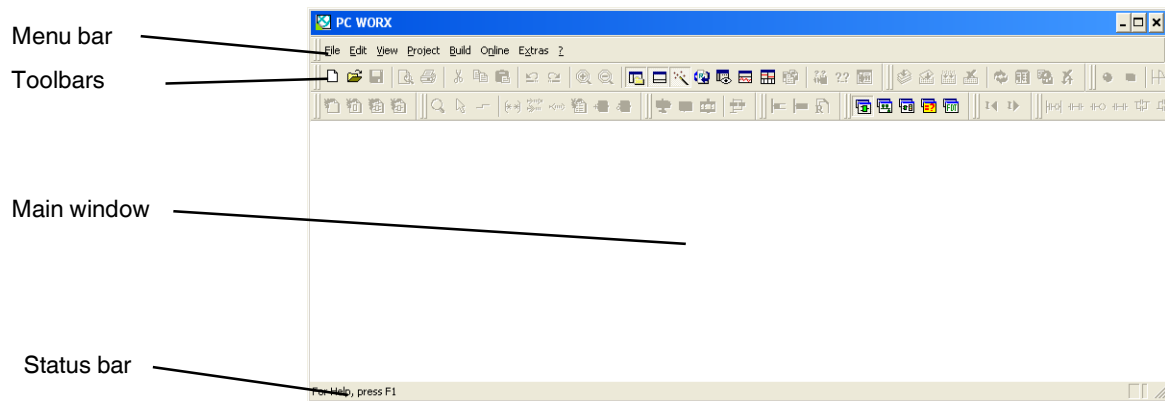

Figure 4-1 User interface

4.3 Toolbars

The program contains several toolbars with different icons, which enable frequently used operations to be executed quickly. Alternatively, these operating steps can be called via menu items or predefined shortcuts.

By default, all the toolbars are shown. To display or hide a specific toolbar, use the "Extras/Options" dialog box.

When the mouse pointer is placed over an icon (without clicking on it), a tool tip appears. The tool tip displays the name of the current icon. In addition, a short function description appears in the status bar. If tool tips are not displayed, this feature can be activated in the "Extras/Options/Toolbars" dialog box.

Icons for selecting the workspace

The workspace can be changed via the icons in the toolbar:



Activate IEC programming workspace.



Activate bus configuration workspace.



Activate process data assignment workspace.



Activate workspace for project comparison.



Activate FDT workspace.



Which windows will actually be displayed depends on which windows have been toggled on. The last setting for each workspace is saved when the program is closed and restored when it is started again.

Frequently used icons for compiling and debugging



Online modifications.



Make (compile project; corresponds to "Build/Make" in the menu bar).



Switch debug mode on/off.



Display project control dialog box.

4.4 Workspaces

PC WorX is divided into the following workspaces:

- IEC programming
- Bus configuration
- Process data assignment
- Project comparison
- FDT.

The "View" menu or the corresponding icon in the toolbar can be used to switch between the workspaces. Following initial installation the IEC programming workspace is the default setting.

Figure 4-2 to Figure 4-6 show the default workspaces. The windows that you wish to display can be defined at any time for each workspace.

IEC programming workspace

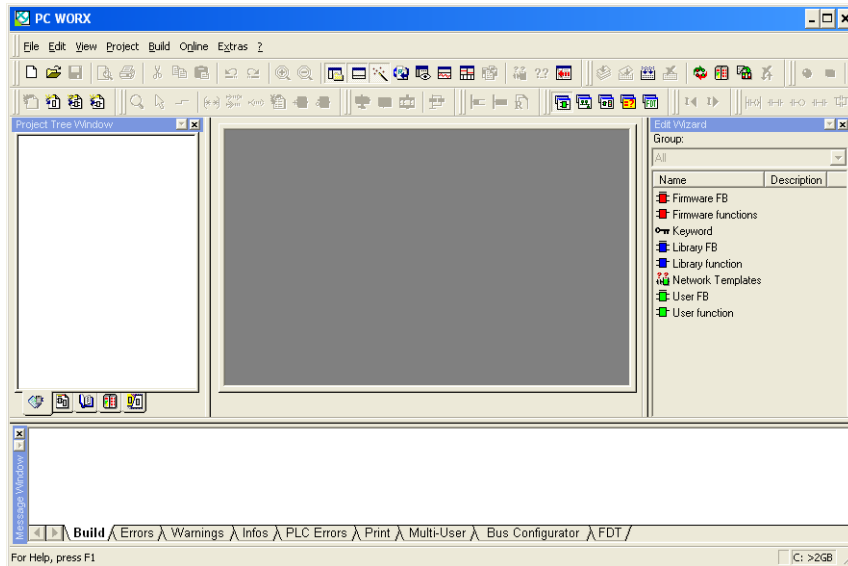

Figure 4-2 IEC programming workspace

Bus configuration workspace

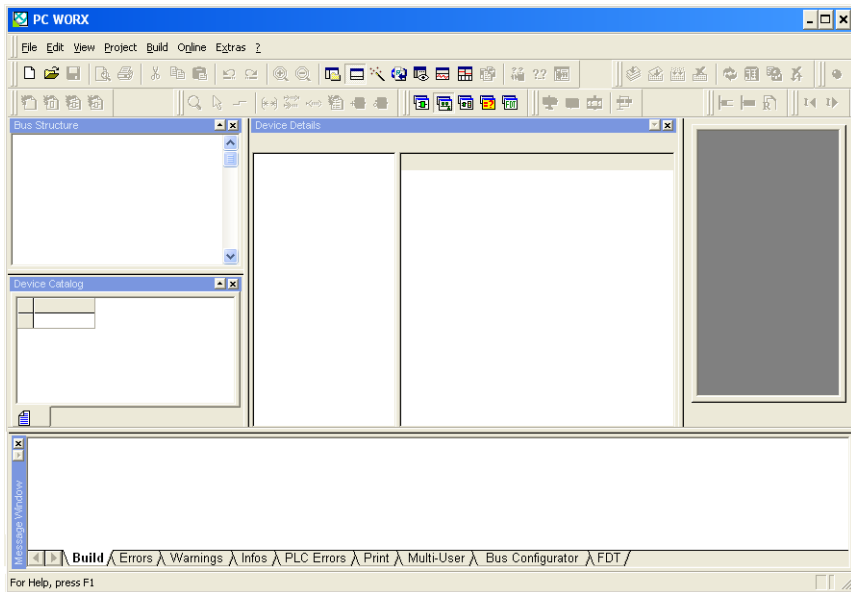

Figure 4-3 Bus configuration workspace

Process data assignment workspace

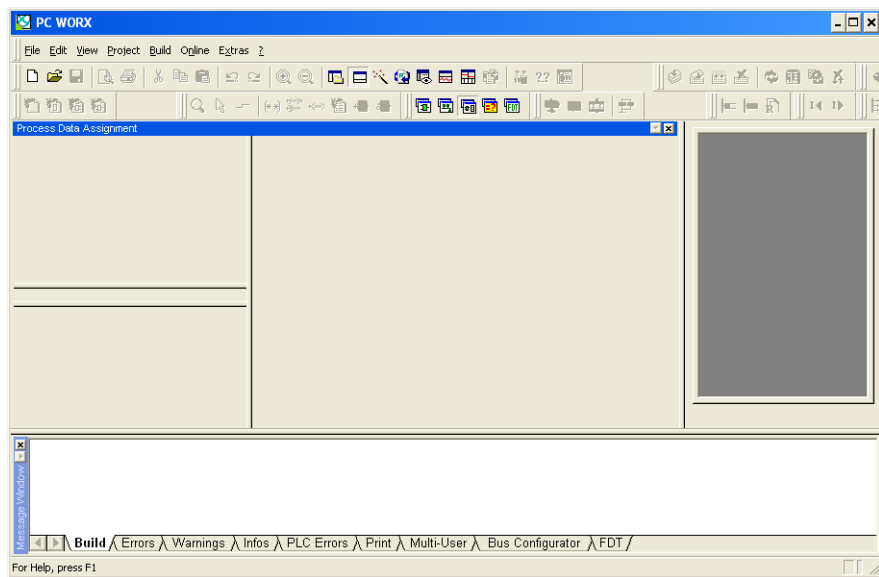

Figure 4-4 Process data assignment workspace

Project comparison workspace

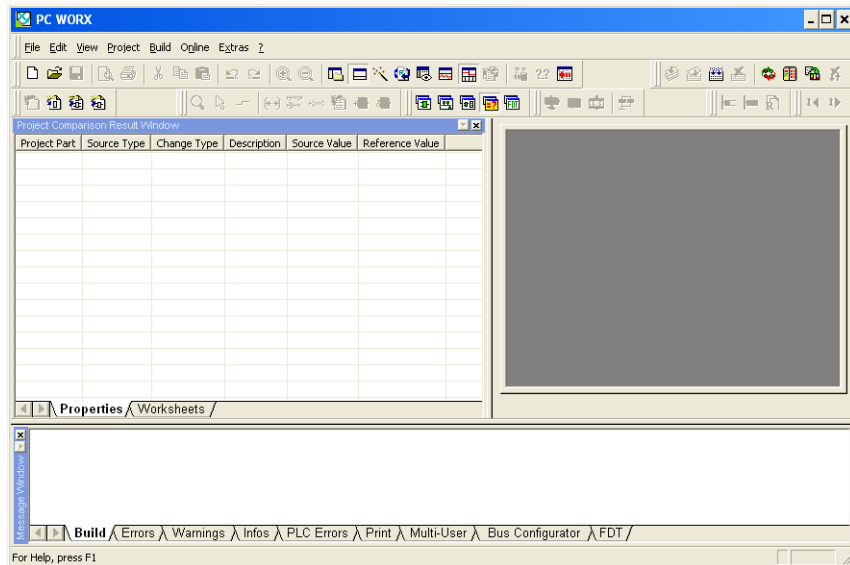

Figure 4-5 Project comparison workspace

FDT workspace

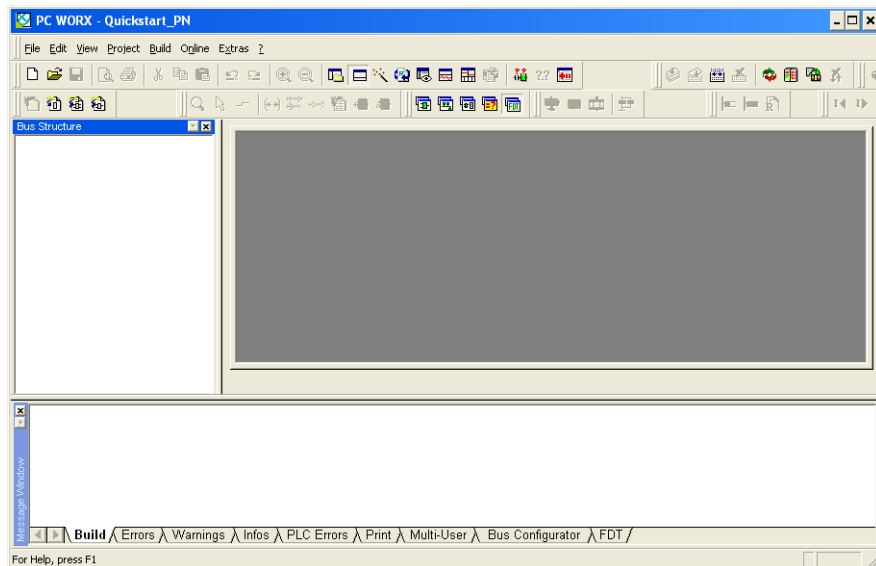

Figure 4-6 FDT workspace

Toggling on/off

Each window can be toggled on/off via the "View" menu by selecting the corresponding menu item.

Docking/undocking

For each window, you can specify whether it is to be docked in the other windows or not. There are various options for docking/undocking windows:

1. Permanent docking/undocking:
In the title bar or the gray frame of the relevant window right-click with the mouse and activate/deactivate the "Allow Docking" menu item.
Move an undocked window to the position where it is to be inserted in the desktop.
2. Undocking temporarily:
Double-click on the gray window frame or the title bar of the window. The window is then displayed as a "normal" window. Its size can be modified and it can be moved to any position on the screen. In order to re-dock the window, i.e., to reinsert it in the desktop, double-click on the title bar.

4.5 "Bus Structure" window





The "Bus Structure" window is used to display and edit the bus topology.

4.5.1 Icons in the "Bus Structure" window

4.5.1.1 Logical device functions

The individual device functions are identified in the "Bus Structure" window with logical icons. The logical icons in the example bus topology have the following meaning:

Table 4-1 Icons for logical device functions (examples)

Icon	Meaning
 Resource	Control system resource When creating the project using a template, the control system resource is inserted below this icon. When creating the project using the wizard, the control system resource is inserted below this icon.
 PROFINET:	PROFINET IO controller Insert all PROFINET IO devices below this icon in the lower level.
 INTERBUS:	INTERBUS master Below this icon, insert the INTERBUS devices that are directly connected to the device that this icon refers to (local bus and remote bus).
 INLINE	Inline Below this icon, insert the Inline terminals that are connected to the Inline bus coupler (local bus).
	PROFINET IO devices: Device proxy and modules For PROFINET IO devices, the display is divided into the device proxy (bus interface) and its modules. The device proxy is indicated with "@". The slot number is specified after the graphical representation of the device proxy or modules (setting in context menu under "Edit Device Representation"). The icons for the device proxy and modules are stored in the device description file (e.g., FDCML, GSD). They may vary from manufacturer to manufacturer. PROFINET IO devices from Phoenix Contact Example 1: FL SWITCH SMCS 8TX Example 2: ILB PN 24 DI16 DIO16-2TX (not included in the starter kit) Default icons, if none are stored in the device description file.

Example 1:

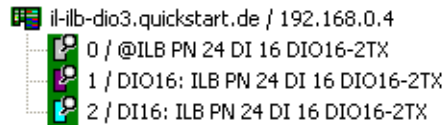

Figure 4-7 Device proxy and modules of a PROFINET IO device (ILB PN 24 DI16 DIO16-2TX, not included in the starter kit)

For the example in Figure 4-7:

- Slot 0 is the device proxy for the PROFINET IO device
- Slot 1 is the DIO module for the PROFINET IO device
- Slot 2 is the DI module for the PROFINET IO device

Example 2:

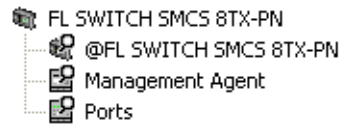
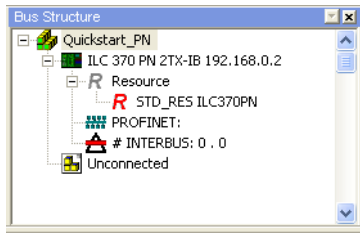
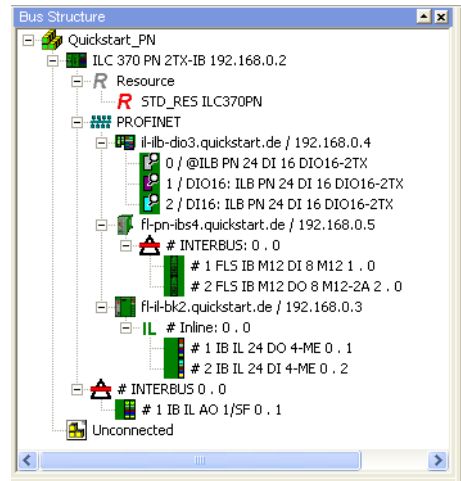

Figure 4-8 Device proxy and modules of a PROFINET IO device (FL SWITCH SMCS 8TX)

Since the modules are fixed components of the PROFINET IO device, each one is marked with a pin. These elements cannot be deleted or replaced.



PROFINET IO controllers







Structure with PROFINET IO devices and INTERBUS devices

Figure 4-9 Example for the representation of devices in the bus configuration

4.5.1.2 Validity of actions

When editing the bus configuration with the mouse, the mouse pointer indicates the validity of your actions.





Table 4-2 Icons when editing the bus configuration

Icon	Meaning
	Insert at the same level The device can only be inserted in/moved to the same level as existing devices.
	Insert in the lower level The device can only be inserted in/moved to a lower level than existing devices.
	Replace The device under the mouse pointer can be replaced by holding down the <Ctrl> key and placing the mouse pointer on the existing device.
	Not permitted This icon indicates a mouse pointer position for which actions are not permitted.

4.5.1.3 Display of status information

In the "Bus Structure" window some icons, which superimpose other graphics, are used to display important status information.

Table 4-3 Icons for displaying status information

Icon	Meaning
	The device is hidden or the bus is deactivated.
	Errors have occurred for the device.
	Warnings have occurred for the device.
	The pin indicates a module that is a fixed component of a device. This element cannot be deleted or replaced.

4.5.2 Display in the "Bus Structure" window



The display of names in the "Bus Structure" window can be adapted to your requirements.

- Switch to the bus configuration workspace.
- In the context menu, open a device via the "Edit Device Representation..." menu item.

Replace...	Ctrl+R
Create DNS/PROFINET Device Names	
Copy Device	Ctrl+C
Copy with Subdevices	Ctrl+T
Cut	Ctrl+X
Paste as Child	Ctrl+B
Paste as Sibling	Ctrl+V
Replace	
Blind out Device	Ctrl+Shift+D
Deactivate Bus	
Delete	Delete
Edit Device Representation...	Ctrl+E
Print Bus ...	
Refresh View	F5

Figure 4-10 "Edit Device Representation..." menu item

- Select the criteria that you would like to see in the display.

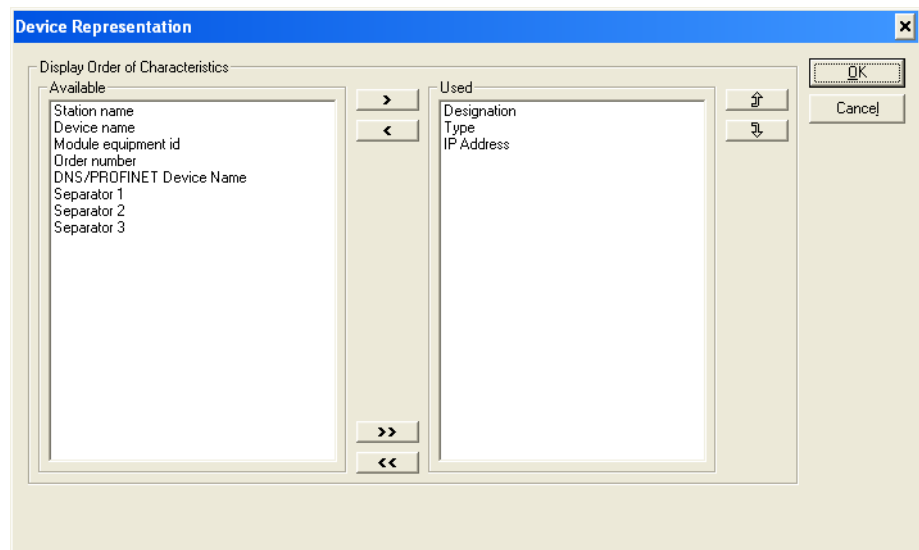
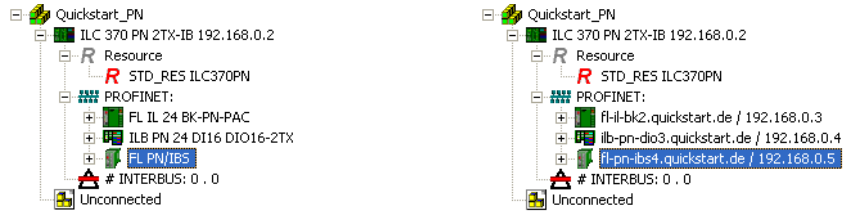

Figure 4-11 Device representations

Examples for different device representations:



Product designation

DNS/PROFINET device name, separator, and IP address

Figure 4-12 Examples for different device representations

The selected representation only affects the representation of a specific device group.

Groups include, for example:

- Control systems
- PROFINET IO devices
- INTERBUS devices

For example, the setting for PROFINET IO devices does not have any influence on the representation of the ILC 350 PN (see Figure 4-12).

4.6 Compiling and transmitting projects, and performing a cold restart

Compiling a project

- When compiling a project for the first time, select the "Rebuild Project" command from the "Build" menu. For further compiling processes you can also use the "Make" command (see also Section "Compiling (additional information)" on page 4-14).
- If errors occur when compiling, repeat the compiling process until it is completed successfully. Error messages must be removed. Warning messages do not have to be removed.



If you have not yet programmed anything, you will receive the "Empty worksheet" warning message. This does not affect the next step. You can ignore it.

Downloading a project



When downloading the control project, the desired PROFINET IO configuration is transmitted and activated.

- Open the project control dialog box.



If only the "Close" button is enabled in the project control dialog box that opens, there is no valid connection to the ILC 350 PN. In this case, check the communication path.

- Select "Download" in the project control dialog box.



Figure 4-13 Project control dialog box

There are various options for downloading the project to the controller.

1. Click the "Download" button in the "Project" area.
2. Click on "Download" in the "Bootproject" area.
3. Activate the "Include Bootproject" checkbox in the "Project" area and click on "Download" in this area.

In the first option, the project is sent. However, it is not loaded automatically when booting the control system.

For option 2 and 3, the project is written as a boot project to the parameterization memory of the control system and is loaded automatically after the control system has been booted.

Option 3 is shown in the following example.

- Activate the "Include Bootproject" checkbox in the "Project" area and click on "Download" in this area.

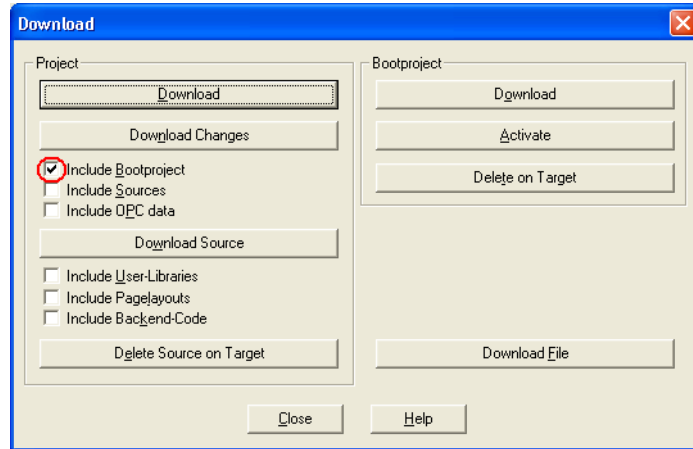

Figure 4-14 "Download" dialog box (as boot project)

The project now is in the main memory of the control system.

Performing a cold restart

In order to activate the project, it is necessary to perform a cold restart.

- To do so, click on "Cold" in the project control dialog box.

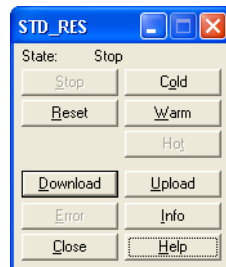

Figure 4-15 Project control dialog

The ILC 350 PN has been started up successfully if the green LED PLC RUN is on.

Compiling (additional information)

There are two options for compiling:

- 1 Build/Make
- 2 Build/Rebuild Project

Rebuild Project

Use this command to compile an **entire** project for the first time or after having modified a user library.

"Rebuild Project" compiles and links all worksheets. Errors and warnings that are discovered by the compiler are logged in the message window. After the syntax has been checked successfully, the system automatically generates the IEC code and the special PLC code. Finally, the project can be sent to the PLC.

The "Rebuild Project" command should only be used if errors occurred when compiling with "Make" or your project was unpacked without frontend.

Make

The "Make" command is the standard mode for compiling. Use this command after editing and completing your project.

When the "Make" menu item is executed, all **modified** worksheets are compiled and linked, and the modified PLC code is generated.

You can execute this command from the menu bar via "Build/Make" using the "Make" icon in the toolbar or by executing the <F9> shortcut.

Modified worksheets in the project tree are identified by an asterisk that appears after the worksheet name.

Both

After the compiler has been started, the message window appears automatically if it was closed before. This window indicates the steps the compiler is currently executing. In addition, errors, warnings, and additional information about the process are logged here.

Once the compiling process has been completed successfully, i.e., no errors have been reported, the modified project can be sent to the PLC.

5 Example project

In this section, it is assumed that the following steps have already been completed:

- The hardware is installed (see Section "Installing hardware" on page 2-1).
- The software is installed (see Section "Installing and enabling the PC WorX 5 software" on page 3-1).

5.1 Overview

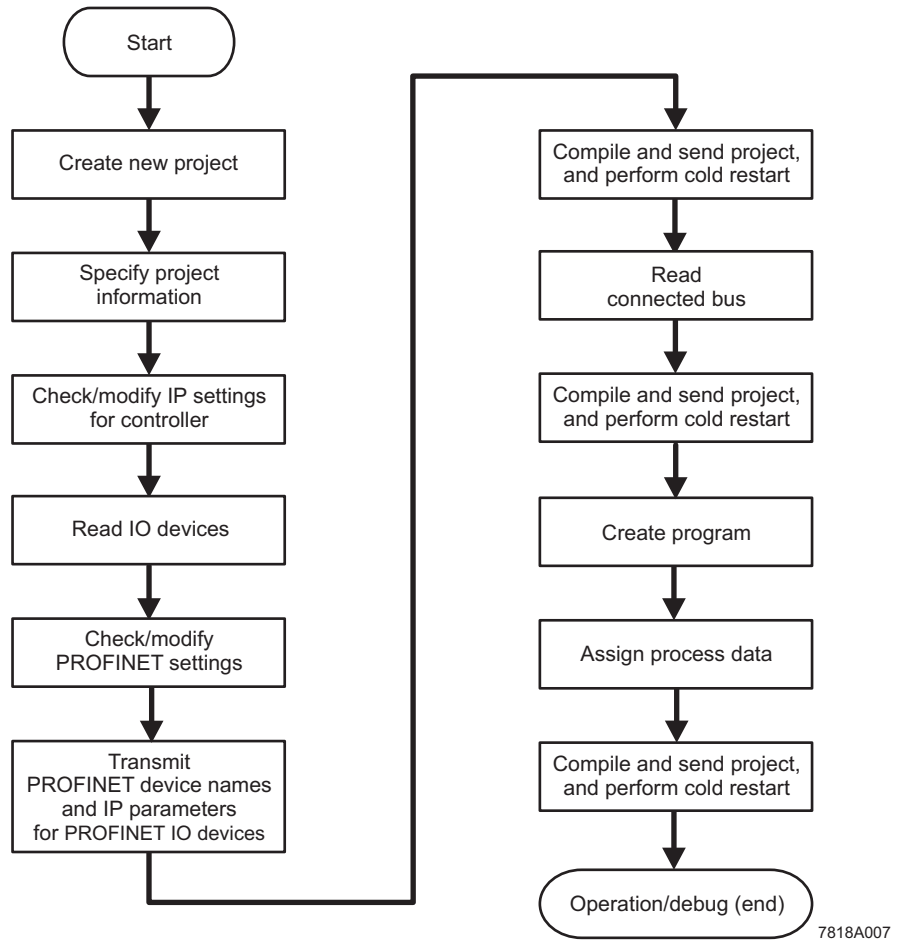

Figure 5-1 Sequence from installation through to operation

5.2 Creating a new project

In the following an example project is developed using Function Block Diagram (FBD).



In order to obtain the best possible results, please use the same identifiers and names as used in this user manual.



This example project is provided on the starter kit CD. For additional information please refer to Section "Example project on CD" on page 5-28.

- Select the "New Project..." command from the "File" menu to create a new project using a template.
- Select the "ILC 3xx" tab because you are using the Inline controller ILC 350 PN.

The tree structure and the selection of the control system are now prepared.

- Select the "ILC 350 PN Rev. >01/4.6F/2.00" control system and confirm your selection with "OK".

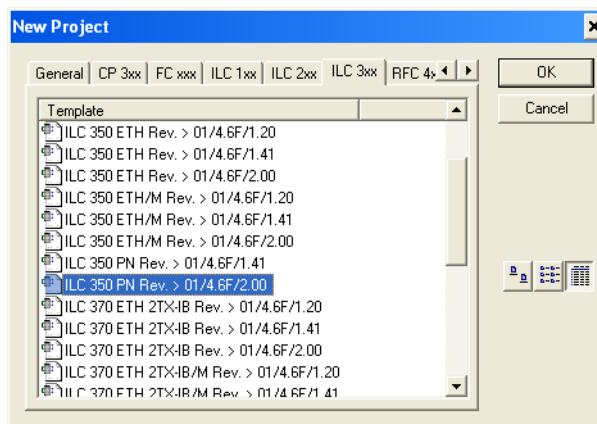

Figure 5-2 Project templates

- Select the "File, Save Project As/Zip Project As..." command.
- Enter a project name (here Quickstart_PN) and save the project.

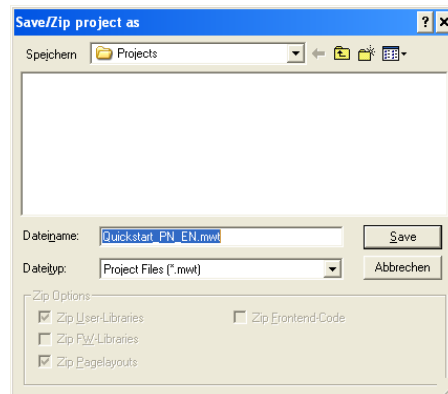

Figure 5-3 "Save/Zip project as" window

5.3 Adapting the project information



- Switch to the bus configuration workspace.

After creating a new project, the project information is displayed in the bus configuration workspace. Here, the settings can be adapted to your project. The project information comprises:

- Domain Postfix
- Template for DNS/PROFINET device name generation
- First and last IP address
- Subnet mask
- Default gateway
- Use DHCP

Project name	Value
Project name	Quickstart_PN_EN
Creator	pyx124
Computer name at project creation	PYRVT0028
PC WORX version at project creation	PC WORX 5.20.17 SP 2.40
Creation date	2008-08-01T12:11:40+01:00
Last editor	pyx124
Computer name at last project backup	PYRVT0028
PC WORX version at last project backup	PC WORX 5.20.17 SP 3.44
Date of last project backup	2008-09-30T10:35:51+01:00
Domain Postfix	
Template for DNS/PROFINET Device Name gen...	
First IP Address	192.168.0.2
Last IP-Address	192.168.0.254
Subnetmask	255.255.255.0
Default Gateway	
Use DHCP	no

Figure 5-4 Project information after creating a new project

Domain Postfix

- Assign the name suffix for the PROFINET device name (here: quickstart.de) in the "Device Details" window under "Domain Postfix".

The following characters are permitted for the "Domain Postfix":

- Lowercase letters without umlauts a to z
- As separators: Period .



Uppercase letters without umlauts are permitted, however, they will be converted to lowercase letters internally. The entry is therefore not case sensitive.

If the "Domain Postfix" is entered at the start of the project, it will be used automatically for all subsequent PROFINET IO devices that are **inserted** in the PROFINET device name (see also "PROFINET device name" on page 5-14).

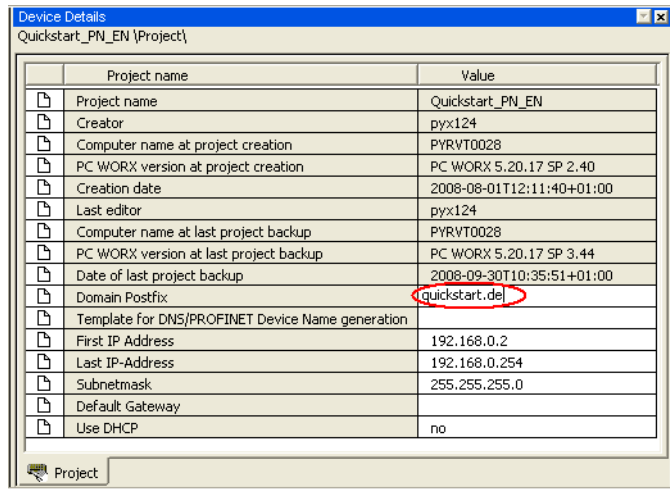

Figure 5-5 Assigning the Domain Postfix

First and last IP address, subnet mask

During project creation, PC WorX automatically assigns an IP address area for a **local network** (area from 192.168.0.2 to 192.168.0.254). If you would like to use another address area (e.g., a **global network**), adapt the start and end address on the project node (here: Quickstart_PN) to your application.

If the IP parameters are modified in the project settings, the IP addresses of the PROFINET IO controller may have to be modified manually (see Section "Checking/modifying the IP settings for the PROFINET IO controller" on page 5-6).

When inserting or reading PROFINET IO devices, PC WorX automatically assigns IP parameters that are within the specified area.



If you are using the addresses of a local network in your project, also assign a corresponding address (e.g., 192.168.0.225) to the PC on which PC WorX is installed. Otherwise the devices in the local network cannot be accessed.

For information about the IP addresses to be used within your system, please contact your system administrator.

If the start address of the new address area to be entered is higher than the previous end address, please modify the end address first.

If you manually assign IP parameters that are outside the defined area, they will not be accepted.

Default gateway

If you are using a default gateway:

- Assign the address for the default gateway under "Default Gateway" in the "Device Details" window.

This address must be within the specified IP address area. If the default gateway is entered at the start of the project, it will be used automatically for all subsequent PROFINET IO devices that are inserted (see also "Default gateway" on page 5-14).

5.4 Preparing the PC for communication

- In the "Extras/PROFINET Configuration..." menu in PC WorX select the network card for your computer that is to be used for communication.

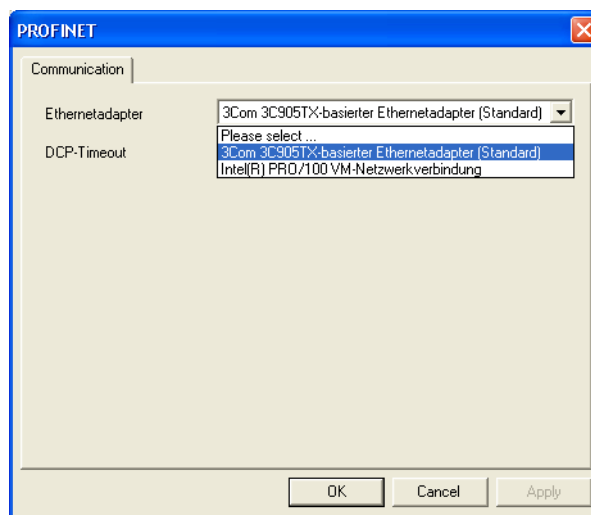

Figure 5-6 Selecting the network card

5.5 Checking/modifying the IP settings for the PROFINET IO controller

The IP settings for the controller are made when the project is created.



NOTE:

If any modifications are made to the project information that affect the IP settings for the controller, a warning is displayed. However, the modification is not implemented automatically.

Adapt these settings, if necessary.



- Switch to the bus configuration workspace.
- Select the controller node.
- In the "Device Details" window, switch to the "IP Settings" tab.
- Check the IP settings and modify, if necessary. Make sure that the controller IP address is within the project IP address area.

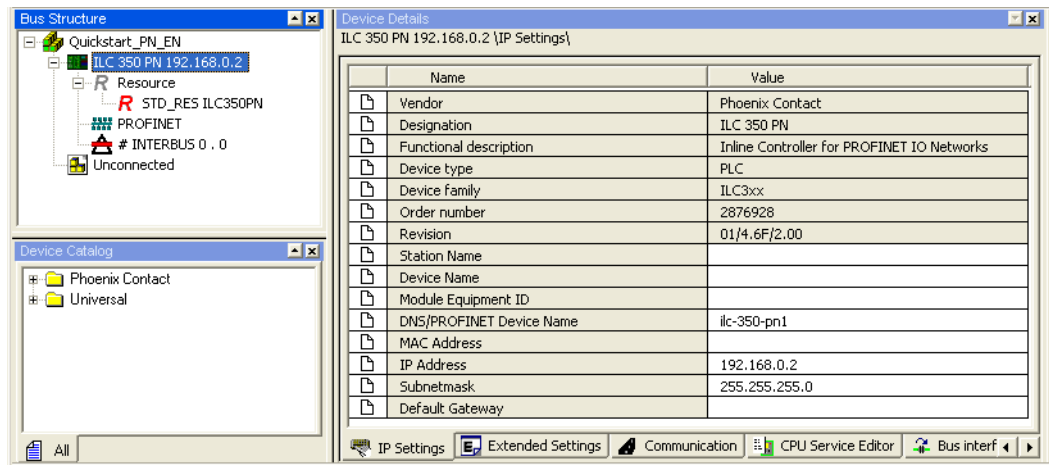

Figure 5-7 IP settings



The IP parameters that are assigned here for the controller are also implemented as the IP parameters for the communication path via TCP/IP.

5.6 Assigning the IP address for the PROFINET IO controller

An IP address must first be assigned to the PROFINET IO controller in order to communicate with the control system.

BootP is activated by default upon delivery for communication with the Inline controller via Ethernet. When setting the IP address for the first time, a BootP server can be used or the address can be set manually via the serial interface. The IP address can be changed later via the serial connection or Ethernet using the PC WorX software.



After assigning the IP parameters, PC WorX automatically creates a link via TCP/IP as a communication path to the ILC 350 PN.

5.6.1 Address assignment via the PC WorX BootP server

- Establish an Ethernet connection between your PC and the PROFINET IO controller.
- In the menu bar, select the "Extras / BootP/SNMP/TFTP Configuration..." menu.

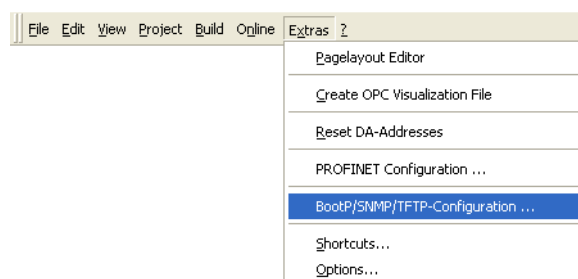

Figure 5-8 Extras/ BootP/SNMP/TFTP Configuration...



- Activate the "BootP server active" checkbox.
- Switch to the bus configuration workspace.
- Select the "ILC 350 PN" node.
- Select the "IP Settings" tab in the "Device Details" window.
- Enter the MAC address of the controller. This can be found on a label on the device. It starts with 00.A0.45.

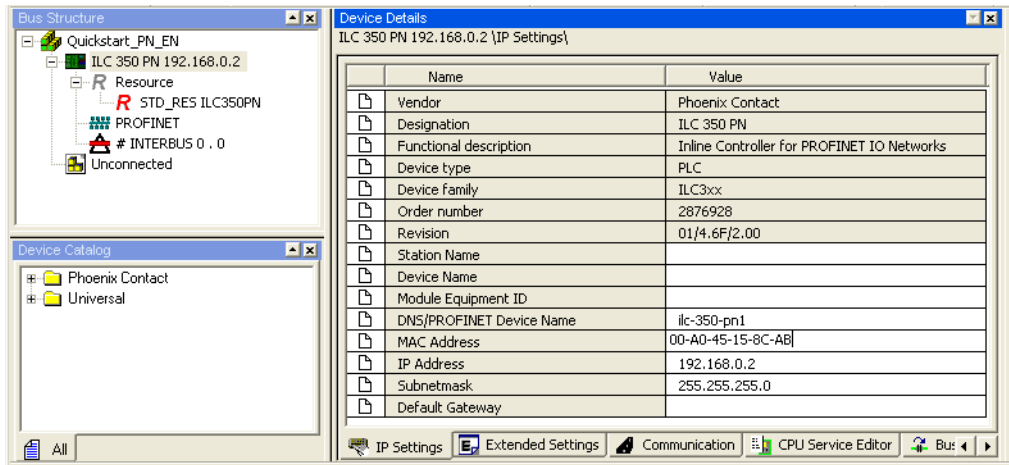

Figure 5-9 Entering the MAC address

- Reset the controller.

The controller is temporarily assigned the IP address, which is specified in the project for the controller.

- Select the "Extended Settings" tab in the "Device Details" window.

The specified IP parameters are displayed under "Manual definition of the TCP/IP settings".

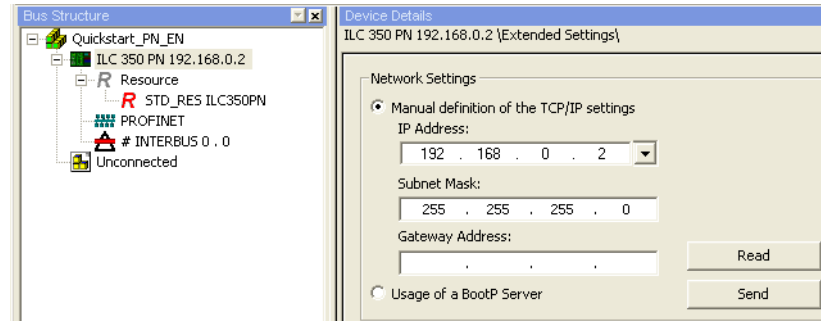

Figure 5-10 IP address of the PROFINET IO controller

- Confirm the displayed IP parameters or your modifications via "Send".

The IP address is now permanently stored on the controller memory card.

5.6.2 Address assignment with PC WorX via the serial interface



If the IP parameters were assigned using the BootP server, this section can be skipped.



- Create a serial connection between your PC and the PROFINET IO controller.
- Switch to the bus configuration workspace.
- Select the "ILC 350 PN" node.
- Select the "Extended Settings" tab in the "Device Details" window.
- Set the communication path in the area at the top of the window (here: COM1).



The communication path set on this page will only be used **temporarily** in order to transmit the data that can be set on this page. If, for example, you do not know the current IP address for your controller and cannot establish an Ethernet connection, a serial connection must be established and the new IP address sent to the controller. The communication path set on this page (in this case: "COM1") is used temporarily for this. For all other actions (e.g., sending the project to the control system) the communication path of the project is used (e.g., "TCP/IP").

- Check the specified communication path by clicking "Test".
The communication path has been tested successfully if a green status indicator appears in the window. If a red status indicator appears, check the communication path and change it, if necessary.
- If the PROFINET IO controller had an IP address, the IP address of the PROFINET IO controller read via the serial connection is displayed under "Network Settings/Manual definition of the TCP/IP settings".

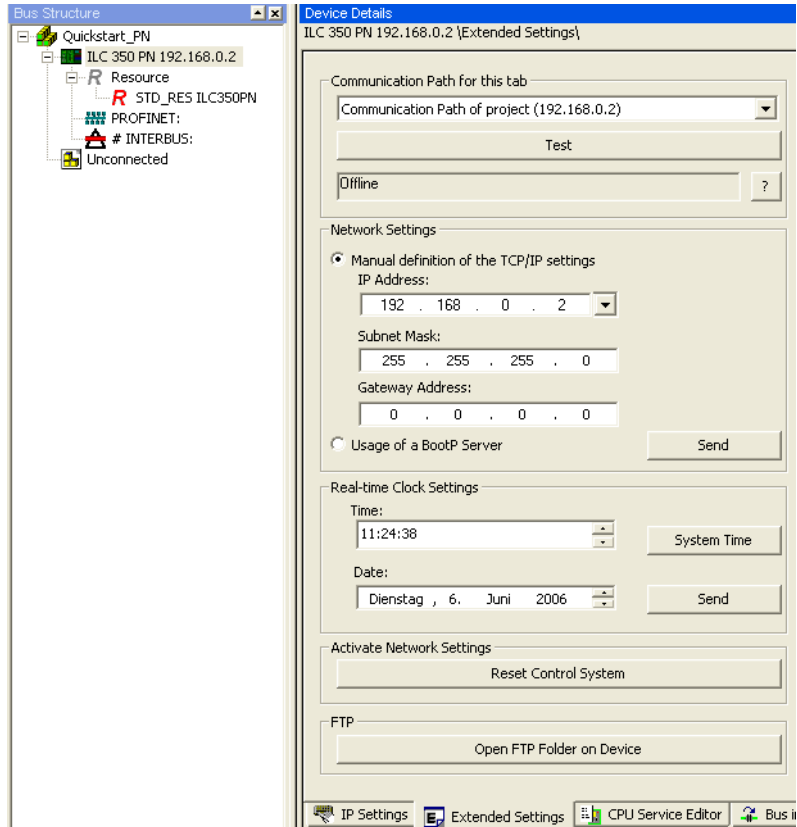

Figure 5-11 Read IP address of the PROFINET IO controller

- If you would like to change the network settings, specify the new settings.
- Confirm the display or your entry via "Send".
- Reset the control system in the "Activate Network Settings" area via "Reset Control System".



The PROFINET IO controller needs some time before it is ready to operate again. It indicates that it is ready via the RUN LED that is either permanently ON or flashing cyclically.

5.7 Reading PROFINET IO devices



- Make sure you are in the bus configuration workspace.
- In the "Bus Structure" window select the PROFINET node for the control system.
- Open the context menu and select the "Read PROFINET..." menu item.

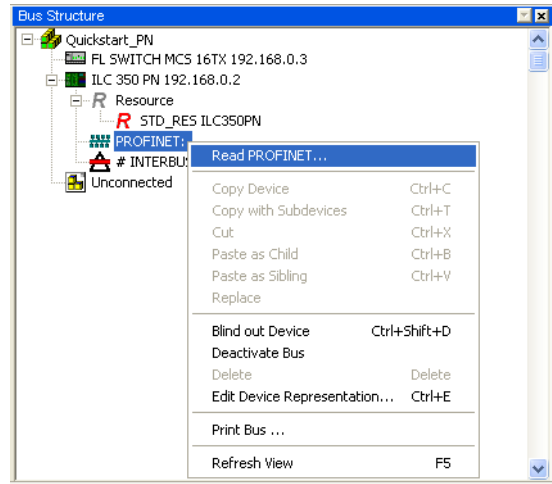

Figure 5-12 Reading PROFINET

All the connected PROFINET IO devices are displayed. When reading, the device name and the IP parameters are read for each device - provided it is present.

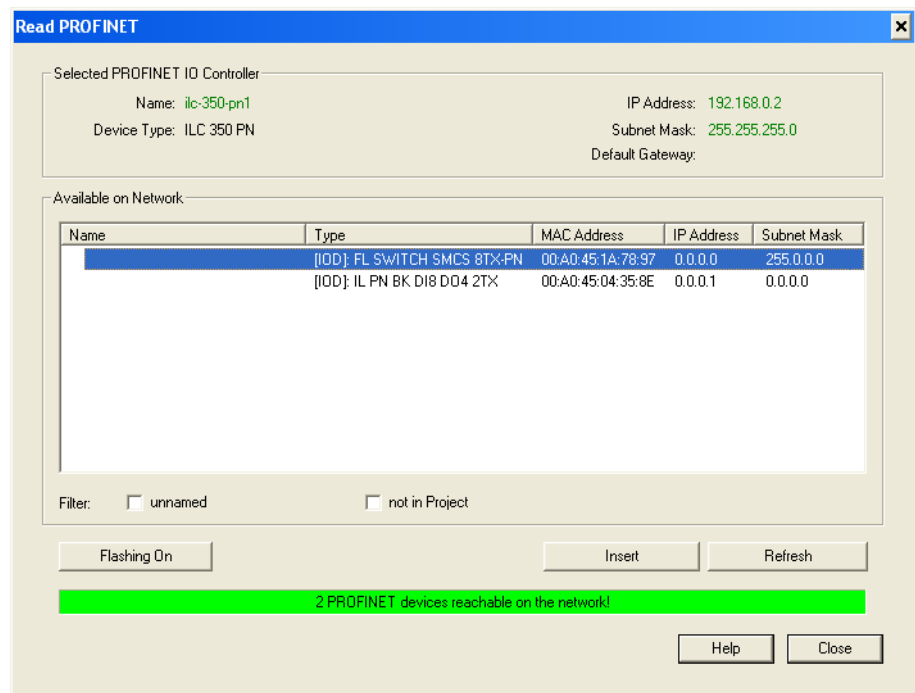

Figure 5-13 Connected PROFINET IO devices selected for the project

- Select the devices that are to be included in your project.
If you want to select several devices use the <Ctrl> key.
- Confirm your selection with "Insert".



The PROFINET IO devices can also be inserted manually from the device catalog. For additional information, please refer to the Quick Start Guide or online help for PC WorX.

- Include the selected PROFINET IO devices in your project by clicking "Insert".

If a device does not yet have a PROFINET device name, a name can be assigned here (activate the "Name Device" checkbox).

- Check the displayed PROFINET device name.

The PROFINET device name is the unique identification for the PROFINET IO device in the network. It must be known to the PROFINET IO device before it can be used within the network.

PC WorX automatically ensures that each device is assigned a PROFINET device name that is unique throughout the entire project. The "Domain Postfix" that was set on the project node is attached to this name (here: quickstart.de).

The PROFINET device name allows for modifications without restrictions
The following characters are permitted for the PROFINET device name:

Lowercase letters without umlauts	a to z
Numbers	0 to 9
Hyphen	-

If the naming conventions have not been observed, an error message is output in the message window and the name is rejected.



Uppercase letters without umlauts are permitted, however, they will be converted to lowercase letters internally. The entry is therefore not case sensitive.

The PROFINET device names that have been assigned automatically by PC WorX are used in the example.

- Assign these names to the relevant device.
- Confirm the display or your entry with OK.

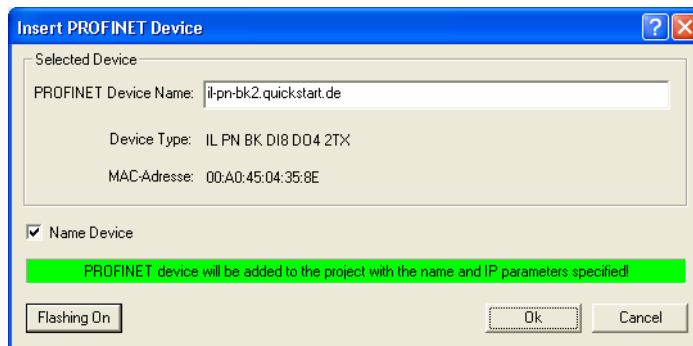

Figure 5-14 Naming a device

- Close the "Read PROFINET" window by clicking on "Close".

The PROFINET topology is displayed in the "Bus Structure" window. The current PROFINET device name was assigned and the IP address was specified for each device.

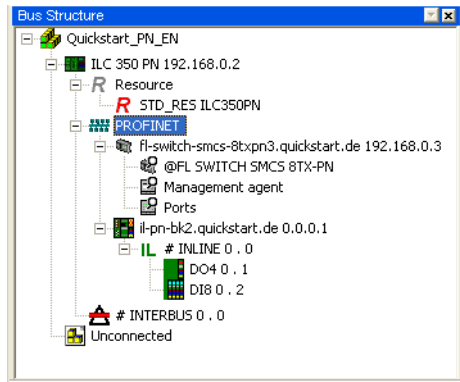

Figure 5-15 Bus configuration with read PROFINET IO devices

The current settings can also be checked in the "Read PROFINET" window. All PROFINET IO devices should now have a PROFINET device name. The IP parameters are only assigned after project download and control system startup.

The updated list contains the PROFINET IO devices together with their PROFINET device names.

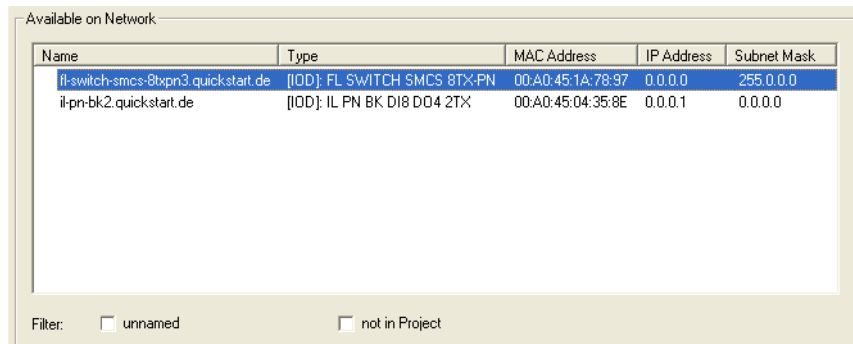

Figure 5-16 All devices with PROFINET device names

5.8 Checking/modifying the PROFINET settings for PROFINET IO devices

When **reading**, the PROFINET settings of the relevant PROFINET IO devices are included with default values. Check these settings and modify, if necessary.



- Make sure you are in the bus configuration workspace.
- In the "Bus Structure" window select the PROFINET IO device.
- Under "Device Details" select the "PROFINET Settings" tab.
- Check the PROFINET settings and modify, if necessary.

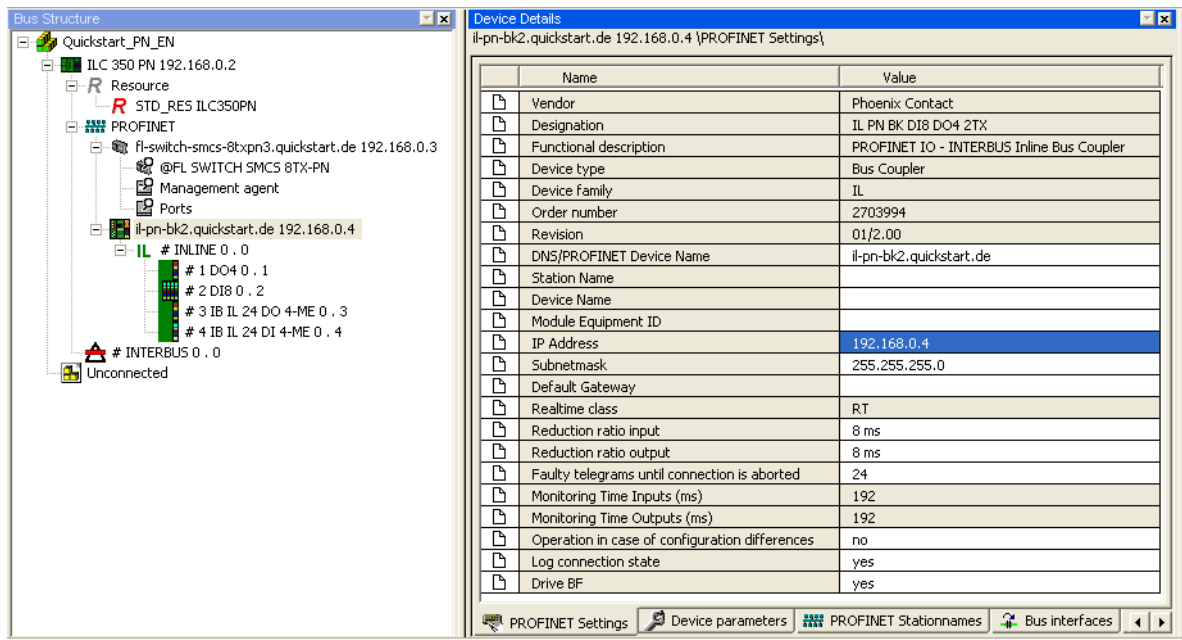

Figure 5-17 PROFINET settings of the device IL PN BK DI8 DO4 2TX-PAC

The PROFINET settings comprise:

PROFINET device name

This name is the unique identification of the PROFINET IO device within the network. It must be known to the PROFINET IO device before it can be used in the network (see also page 5-12).

IP address

During operation, the device can be accessed via the IP address. PC WorX selects the address out of the area that is set on the project node.

Subnet mask

As default subnet mask, the subnet mask that is given on the project node is assigned to each PROFINET IO device. It can be modified specifically for each individual device.

Default gateway

If a default gateway is used, enter its IP address here. The default gateway specified on the project node is automatically assigned to each PROFINET IO device.



IP address, subnet mask, and default gateway represent the **IP parameters** for a device.



If device names are modified here, these modifications must also be applied to the PROFINET IO device. Otherwise the PROFINET IO device will not be found.

Reduction ratio input/ Reduction ratio output

The time in which the inputs/outputs of the PROFINET IO devices are updated. It can be set individually for each PROFINET IO device for each data direction.

The reduction ratio (update time) directly affects the number of PROFINET IO devices that can be operated via a PROFINET IO controller. The pre-setting displayed in PC WorX is a value that has been stored in the FDCML file for the corresponding PROFINET IO device. If this settings exceeds the performance level of the PROFINET IO controller, a corresponding error message appears when translating the project. In this case, select a longer update time for certain devices.

Monitoring time

Setting this time decides how long the PROFINET IO devices cannot receive valid PROFINET telegrams before substitute values are written to the outputs. This setting can affect the "noise immunity" of the network.



NOTE: Errors within the process

Please observe that too high settings can lead to errors within the process because the PROFINET IO device "freezes" the last output value until the error is detected.

Operation in case of configuration differences

This button affects the start-up behavior of the control system for devices that return "ModuleDiffBlock" information in the PROFINET IO parameterization sequence to the control system.

- No: Default setting. If there are configuration differences, connection to the device is aborted. The user must download a new parameterization to start the device.
- Yes: The connection is maintained even for configuration differences.

Log connection state

This button influences the connection logging in the control system for every device.

- Yes: Default setting. A message is written into the diagnostics archive of the control system for every connection abort and connection re-establishment.
- No: Logging is stopped, for instance, because the device shutdown is an application-specific situation.

Drive BF

This button determines whether the BF LED and the PNIO_SYSTEM_BF system variable are to be driven on the control system when there is no connection to the selected device.

- Yes: Default setting. Every connection abort is indicated with the BF LED and a system variable set to TRUE.
- No: Indication is stopped, for instance, because the device shutdown is an application-specific situation.

5.9 Transmitting PROFINET device names and IP settings to PROFINET IO devices

- Make sure that the PROFINET IO controller can establish communication with the PROFINET IO devices.
- Compile the project, send it to the control system, and perform a cold restart. Proceed as described in Section "Compiling and transmitting projects, and performing a cold restart" on page 4-12.

During startup, the ILC 350 PN automatically assigns the IP settings and device parameterizations specified in the project to the PROFINET IO devices.

- To check the assignment of device names and IP settings, select the "PROFINET Stationnames" tab in the "Device Details" window.

The updated list contains the PROFINET IO devices together with their PROFINET device names and the IP parameters.

Name	Type	MAC Address	IP Address	Subnet Mask
il-switch-smcs-8txpn3.quickstart.de	[(OD): FL SWITCH SMCS 8TX-PN	00:A0:45:1A:78:97	192.168.0.3	255.255.255.0
il-pn-bk2.quickstart.de	[(OD): IL PN BK D18 D04 2TX	00:A0:45:04:35:8E	192.168.0.4	255.255.255.0

Filter: unnamed not in Project

Figure 5-18 All devices with PROFINET device names and IP address

The BF LED is now OFF on all PROFINET IO devices.
The PROFINET network is running.

5.10 Reading the connected bus

The process for reading local bus modules that are connected to a PROFINET IO controller or a PROFINET IO device is essentially the same.

Local bus devices connected to a **PROFINET IO controller** can be read once the communication path has been established to the PROFINET IO controller.



In the example configuration (see Figure 2-4) no further modules are connected to the ILC 350 PN.

Local bus modules that are connected to **PROFINET IO devices** can be read once the device names and IP addresses have been specified for the PROFINET IO devices. In the example project, IL PN BK DI8 DO4 2TX-PAC Inline terminals are connected to the bus coupler.

Procedure

- Select the "Connected Bus" command from the "View" menu to read the connected local bus.

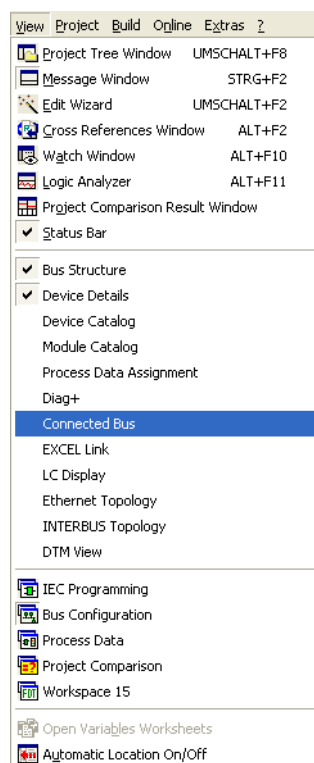

Figure 5-19 "View, Connected Bus" command

- Select the control system in the "Connected Bus" window.



For PROFINET, the PROFINET IO devices can also be selected as the control system (IL PN BK DI8 DO4 2TX-PAC in Figure 5-20).

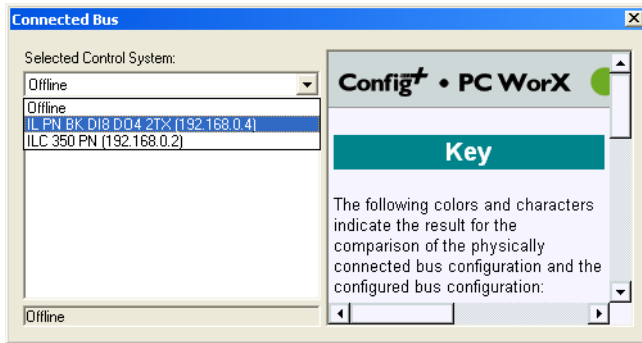

Figure 5-20 Selecting the control system: IL PN BK DI8 DO4 2TX-PAC

This activates the "online" operating state and the control system reads the connected configuration.



The product designation or the station name is displayed under "Selected Control System". If several devices of the same type are used in a project, first assign the devices a station name. This enables the unique identification of the devices.

Once the control system has read the connected local bus, the devices must be imported into the project.

- To do this, select the control system (the PROFINET IO device) in the "Connected Bus" window.
- Open the context menu and select the "Import to Project, With Device Description" command.

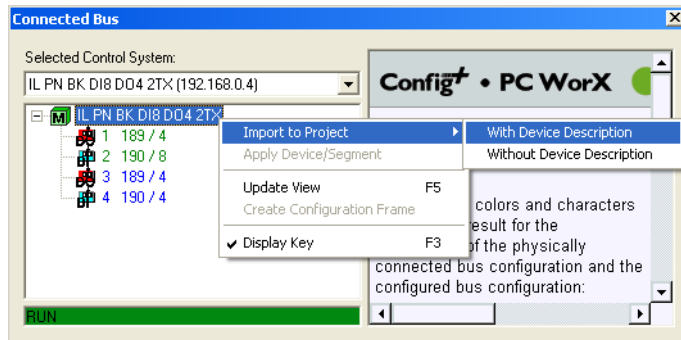

Figure 5-21 Importing devices into the project

The "Select Device" window lists the modules, whose device description corresponds to that of the connected devices.

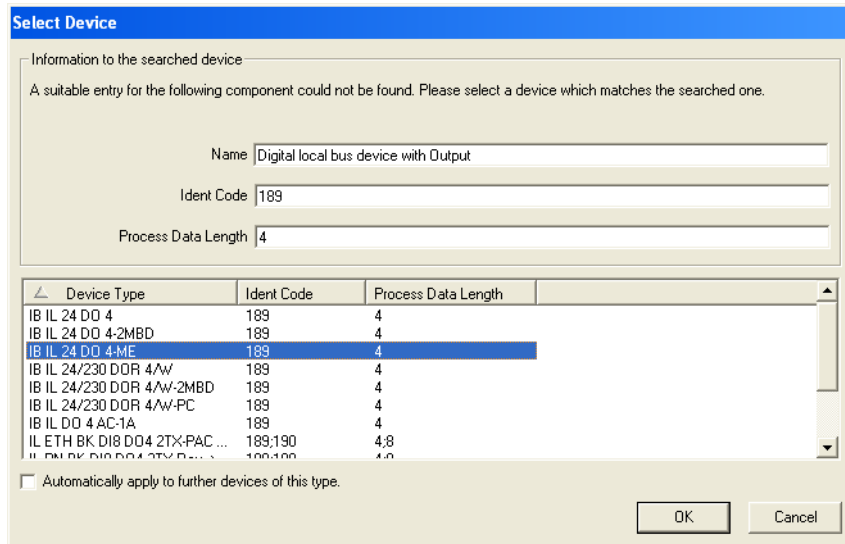

Figure 5-22 "Select Device" window

- Select the device that is actually connected to the system, and repeat this step until all the devices are linked to their device descriptions.

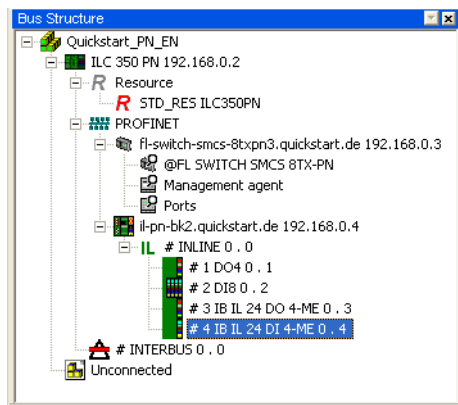

Figure 5-23 Complete bus configuration for the example project

- Disconnect the link by selecting "Offline" as "Selected Control System" in the "Connected Bus" window.

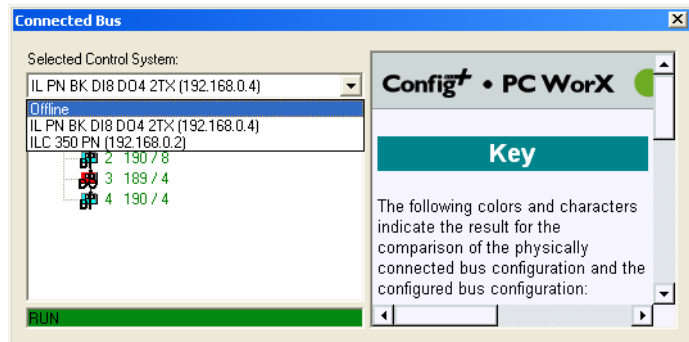

Figure 5-24 "Connected Bus" window

5.11 Compiling and sending a project, and performing a cold restart after reading the bus topology

Now the bus topology is entirely contained in the project. At this point you can compile your project in order to detect any errors that may have occurred.

In order to start up the project, compile it, send it to the control system, and perform a cold restart.

Proceed as described in Section "Compiling and transmitting projects, and performing a cold restart" on page 4-12.

The Inline station is started up at the IL PN BK DI8 DO4 2TX-PAC bus coupler, the D LEDs on the Inline terminals are permanently on.

The system comprising PROFINET and local bus is running.

5.12 Programming an example program including variable creation

In the example, a function block is used for logical ANDing. The **ONBOARD_INPUT_BIT10** (system variable) and **IN2** (user variable) variables map the status of the inputs to which the toggle switches are connected. **ONBOARD_INPUT_BIT10** and **IN2** are ANDed. The result of ANDing is the **OUT** variable (user variable).

For programming, proceed as follows:



- Switch to the IEC programming workspace.
- Double-click on "Main" in the "Project Tree Window" to activate the IEC programming interface.
- In the "Main" worksheet, click on the empty position where you would like to insert the function block.

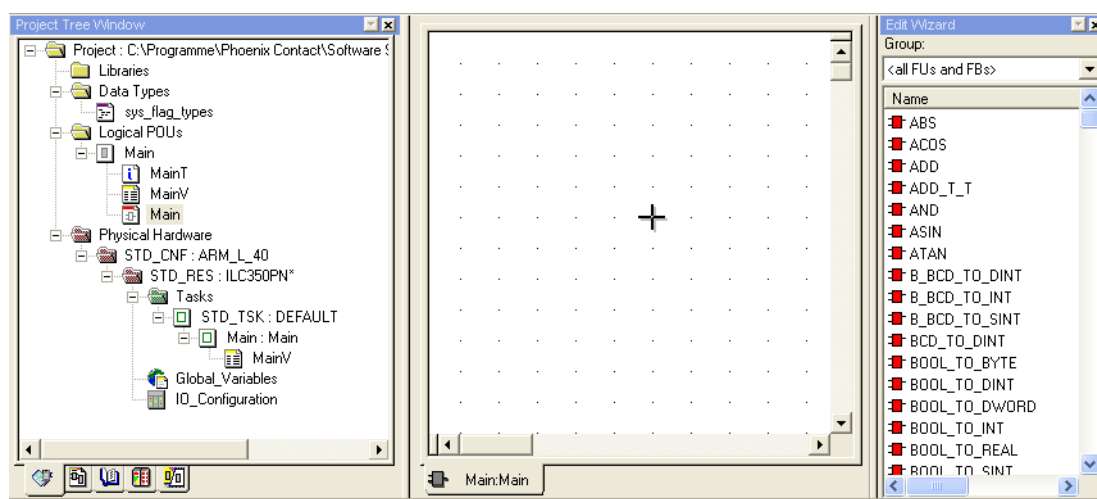

Figure 5-25 IEC programming workspace

AND block for inputs and outputs



Selection of the range of validity is limited when you use automatic management of variables (see "Automatic management of VAR_EXTERNAL" on page 3-1).

- Select the "AND" function block by double-clicking on it in the "Edit Wizard" window.

The function block is inserted in the worksheet.

When specifying the input and output variables please observe the different procedures for system variables and user variables.

According to Table 2-1 „Inputs and outputs used in the example“ on page 2-3, input 11 of the ILC 350 PN is to be evaluated for the first input signal. The onboard inputs and outputs of the ILC 350 PN are mapped on system variables.

- Double-click on the first input parameter of the function block to specify variable properties.
- Open all folders under "Global Variable Groups" and select the "System Variables" in the "STD_RES" folder.
- At the top of the section, select "Global" as the scope of validity.

- Select the corresponding variable under "Name". For input 11 of the ILC 350 PN, the corresponding variable is ONBOARD_INPUT_BIT10.
- Confirm your entries with "OK".

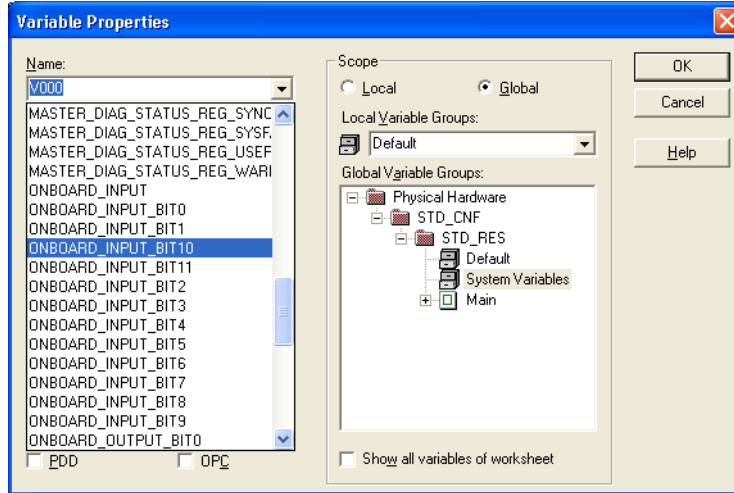

Figure 5-26 Variable properties (system variables)

Now define all the other variables. All user variables are applied as VAR_EXTERNAL and belong to the BOOL data type.

- Double-click on the second input parameter of the function block to specify the variable properties.
- In the scope of validity for "Global Variable Groups", select "Default" under "STD_RES".



Setting the scope of validity is only necessary when defining a variable for the first time. All other variables are also entered in the "Default" group.

- Specify the scope of validity as "Local".
- Assign the name for the variable (here: IN2) in the "Variable Properties" window.
- Select "VAR_EXTERNAL" in the "Usage" selection box because the variable will later be linked to a process data item.
- Confirm your entries with "OK".

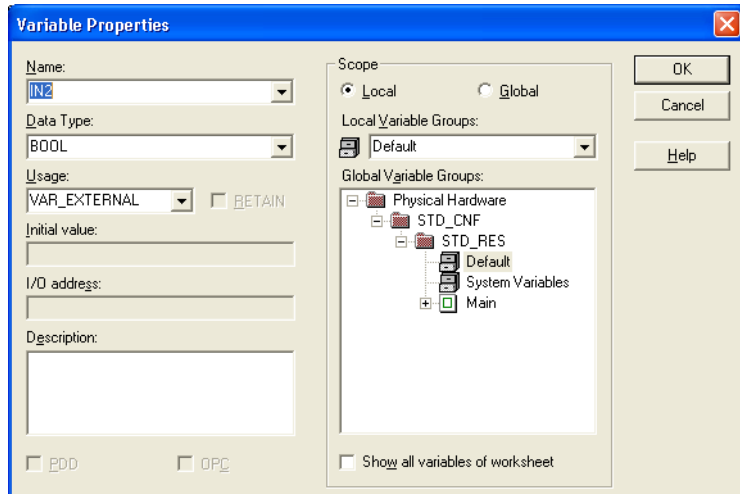

Figure 5-27 Variable properties

- Repeat this procedure for all variables (also for OUT in the example).

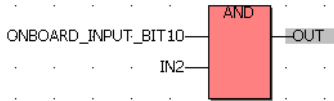

Figure 5-28 ANDing for inputs and outputs

5.13 Compiling after creating the program

At this point you can compile your project in order to detect any errors that may have occurred.



- Select the "Build/Make" command.

5.14 Assigning process data



Process data and control variables are assigned in the process data assignment workspace.

If INTERBUS devices are connected, assignment is seamless for INTERBUS and PROFINET IO.

Link the process data of all devices to variables.



- Make sure you are in the process data assignment workspace.
- Select the control system in the top right window. The standard configuration is then displayed in the top left window, "Symbols/Variables".
- In the top left window, "Symbols/Variables", select the "STD_RES: ILC350PN" resource.
- In the upper right window, select the device for which you would like to link the process data to variables (here: IB IL 24 DI 4-ME).
- Select the process data item to be linked (here: 1.1).
- Variables IN2 and OUT are created when the program is created. Using drag & drop, link the selected variable to one of the variables (here: IN2) on the left-hand side.

In the bottom left window, the assignment between variables and process data is displayed.

The screenshot shows the 'Process Data Assignment' workspace with three main panes. The top-left pane shows the 'Symbols/Variables' tree with 'STD_RES: ILC350PN' selected. The top-right pane shows the device tree for 'Quickstart_PN_EN', with 'IB IL 24 DI 4-ME' selected. The bottom pane is a table showing the assignment of process data items to variables.

Symbol/...	Data Type	Process Data Item
IN2	BOOL	IB IL 24 DI 4-ME \ 1.1
OUT	BOOL	

Device	Process Data Item	I/Q	Data Type	Byte.Bit	Address	Symbol/Variable
IB IL 24 DI 4-ME	1.1	I	BOOL	0.0		STD_CNF STD_RES \ IN2
IB IL 24 DI 4-ME	2.1	I	BOOL	0.1		
IB IL 24 DI 4-ME	1.4	I	BOOL	0.2		
IB IL 24 DI 4-ME	2.4	I	BOOL	0.3		
IB IL 24 DI 4-ME	~DI 4	I	BITSTRING[4]	0.0		

Figure 5-29 Process data item 1.1.1 assigned to variable IN2

- Repeat this procedure for all inputs to be evaluated and for all outputs to be controlled.

For this particular example this means:

- Select the DO module of the IL PN BK DI8 DO4 2TX-PAC device.
- Select the process data item to be linked (here: OUT2).
- Using drag & drop, link the selected variable to the OUT variable on the left-hand side.

Figure 5-30 illustrates the linking of user variables used in the program.

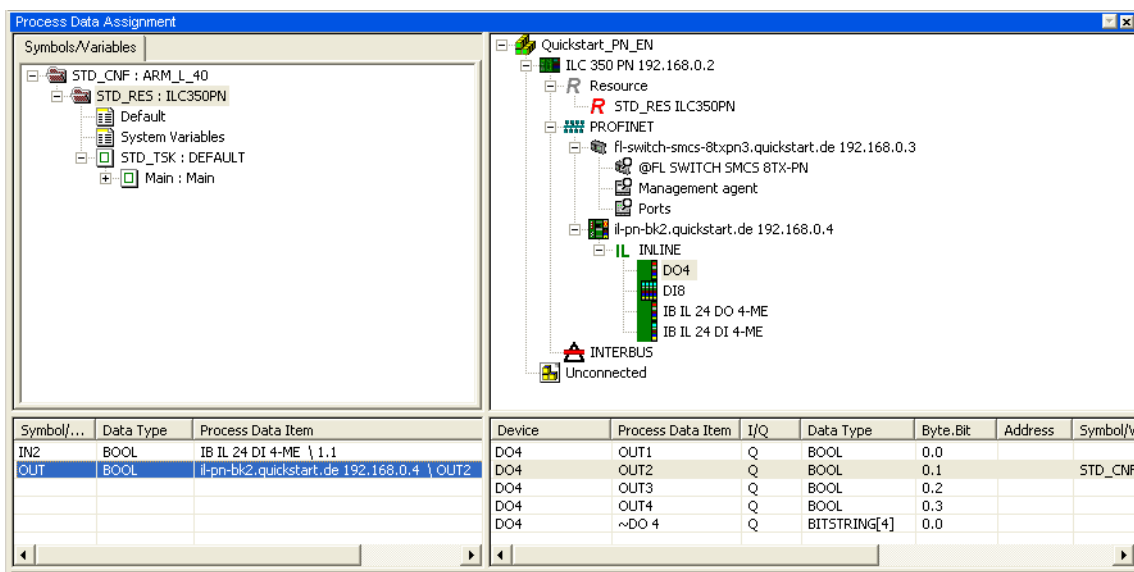

Figure 5-30 All used process data assigned to variables



System variables (e.g., ONBOARD_INPUT_BIT10) are not displayed in this process data view.

5.15 Compiling and sending a project (including program), and performing a cold restart

Now the project has been completed. In order to startup the project, compile it, download it onto the control system and perform a cold restart.

- Proceed as described in Section "Compiling and transmitting projects, and performing a cold restart" on page 4-12.

The project has been successfully started.

5.16 Operation and debug mode

The toggle switch can now be pressed and the response at the output checked. The method of operation of the program can be monitored in PC WorX by switching to debug mode.



- Activate debug mode.
- Switch to the IEC programming workspace.

The status of all global variables in the program is displayed under "MainV" in the "Project Tree Window".



If you use automatic management of variables (see "Automatic management of VAR_EXTERNAL" on page 3-1), the variables are only visible under "Global_Variables" and not under "MainV".

The screenshot shows the Project Tree Window on the left and a table of variables on the right. The table has columns for Name, Online value, Type, Usage, and Description.

Name	Online value	Type	Usage	Description
Default				
ONBOARD_INPUT_BIT10	TRUE	BO...	VAR_EXTERNAL	Local input IN11
IN2	FALSE	BO...	VAR_EXTERNAL	
OUT	FALSE	BO...	VAR_EXTERNAL	

Figure 5-31 Variables in debug mode: Local, program-global variables

The program status of a POU (Program Organization Unit) is displayed by opening the program worksheet (in Figure 5-32: under "Main" in the "Project Tree Window" or under "Main:Main" on the tab in the worksheet).

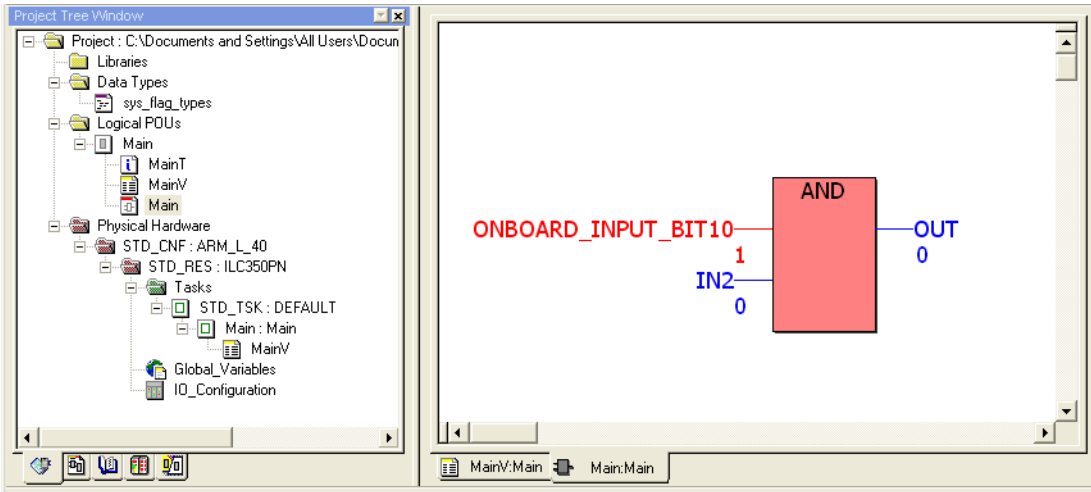

Figure 5-32 Variables in debug mode: Program variables

The status of all global variables is displayed under "Global Variables" in the "Project Tree Window".

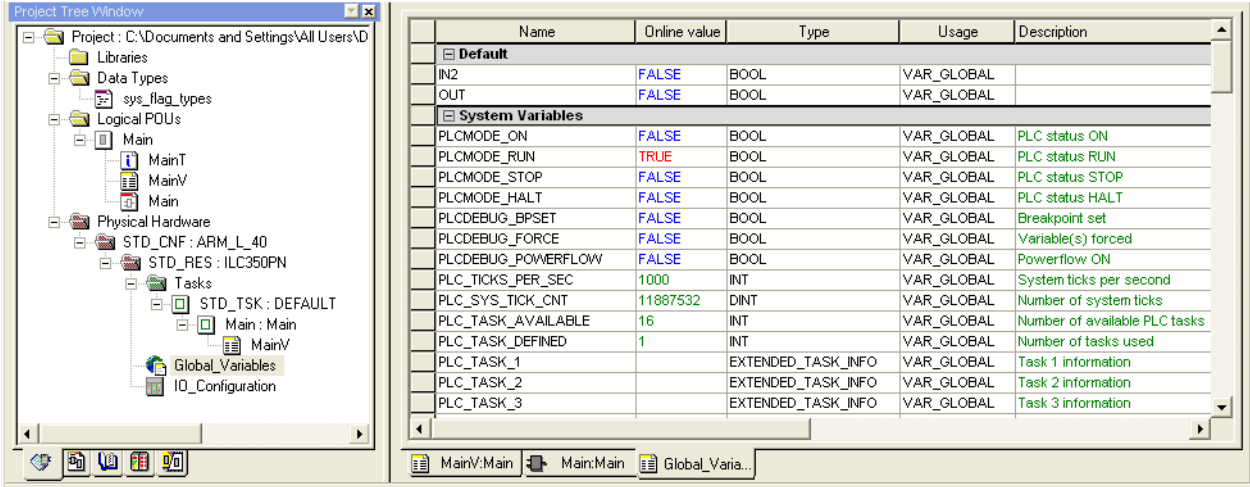

Figure 5-33 Variables in debug mode: Global variables

- Switch to the window that provides the best display of the required information.

5.17 Example project on CD

The example project developed in the previous sections is available in packed format on the CD for the PROFINET starter kit 3.0. It is the "Quickstart_PN.zwt" file.

If you would like to test the project without developing it yourself, you can use this file.

In order to completely take the project into operation, the example bus structure must be structured in accordance with Section "Installing hardware" on page 2-1.

Proceed as follows to start up the project completely.

- Save this file on your PC, e.g., under the default path for PC WorX "C:\Program Files\Phoenix Contact\Software Suite\Projects".



If there already is a "Quickstart_PN" project on your PC, rename the project from the CD, e.g., as "Quickstart_PN_CD.zwt".

- Select "Open Project/Unzip Project" under the "File" menu item.
- Select the "Quickstart_PN.zwt" file from the path under which you saved the file. PC WorX automatically extracts the file.
- Prepare your PC for communication (see Section "Preparing the PC for communication" on page 5-5).
- Set the IP address specified in the project on the PROFINET IO controller (192.168.0.2) or accept the IP address of the PROFINET IO controller in the project (see Section "Checking/modifying the IP settings for the PROFINET IO controller" on page 5-6).
- Compile the project, send it to the control system, and perform a cold restart (see Section "Compiling and transmitting projects, and performing a cold restart" on page 4-12).

You have successfully started up the project and can, for example, work in debug mode (see Section "Operation and debug mode" on page 5-26).

6 Additional functions of PC WorX

6.1 Modifying the PROFINET device name

If a PROFINET connection has been established you may not assign PROFINET device names. Abort these connections first. To do this, proceed as follows:



- Open the project control dialog box.
- Activate the "Stop" button.
- Activate the "Reset" button.

The BF LEDs on the devices are OFF.

All Ethernet connections are aborted and the PROFINET device names can now be assigned.

You may now modify the PROFINET device names. To do this, proceed as follows:



- Make sure you are in the bus configuration workspace.
- In the bus configuration, select the PROFINET IO device which is to be assigned the name.
- Select the "PROFINET Settings" tab in the "Device Details" window.
- Modify the device name under "DNS/PROFINET Device Name".
- In the "Device Details" window, select the "PROFINET Stationnames" tab.

When the tab is selected, the list is updated. If you would like to update the list again later, click on "Refresh".

In order to limit the search results, different options are available:

No filter set	All devices that are available in the network are listed.
Unnamed	All those devices that do not yet have a PROFINET device name are listed.
Same type	Only those devices that are the same type as the device selected in the bus configuration are listed.
Not in project	All those devices that are not included in the project are listed.

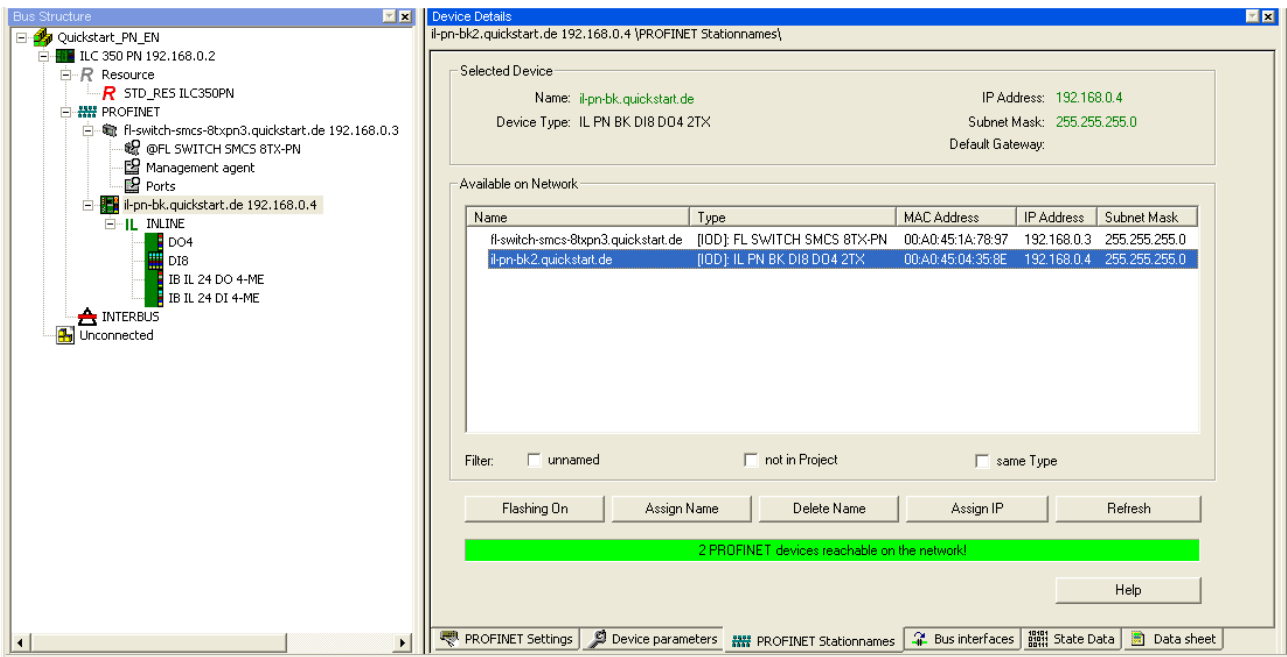

Figure 6-1 List of all PROFINET IO devices that can be accessed in the network

In the "Selected Device" area, the PROFINET IO device name specified under "IP Settings" is displayed.

- From the list, select the corresponding PROFINET IO device (e.g., using the indicated MAC address).

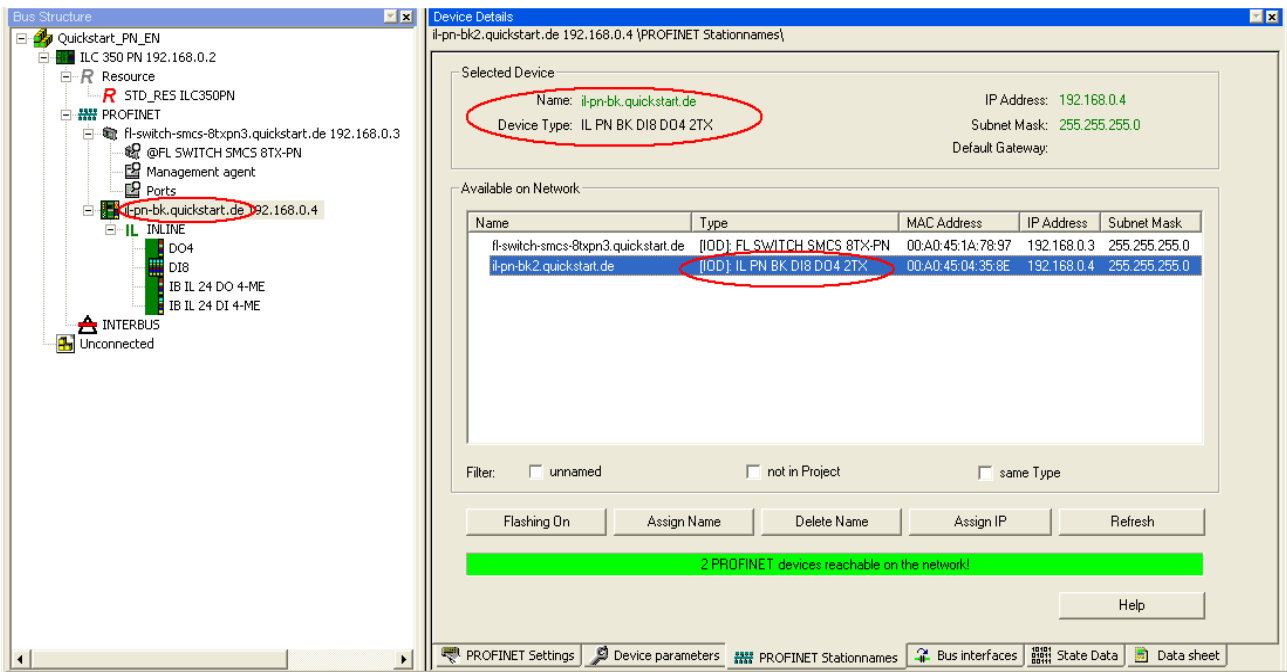

Figure 6-2 Select device

A flashing display on the device can be triggered with the "Flashing On" button. This display can be used to find the selected device in the field.

When the button is activated, the devices in the example system flash as follows:

FL SWITCH SMCS 8TX Flashing SPD and FD LEDs
IL PN BK DI8 DO4 2TX-PAC Flashing LINK1 and LINK2

The flashing process is also indicated in the list.

- Send the name to the device via "Assign Name".



If you receive an error message, first delete the name via "Delete Name" and then assign the name again.

The PROFINET device name is transferred from the PC to the PROFINET IO device.

- Compile the project, send it to the control system, and perform a cold restart (see "Compiling and transmitting projects, and performing a cold restart" on page 4-12).

6.2 Renumbering devices

There is also the option of automatically regenerating the IP parameters (e.g., IP addresses, Domain Postfix) for all devices. The settings from the project information are used for this.

- Select the project node.
- In the context menu select "Renumber Devices/Whole project" and then the menu item for renumbering the devices (e.g., "All DNS/PROFINET Device Names").

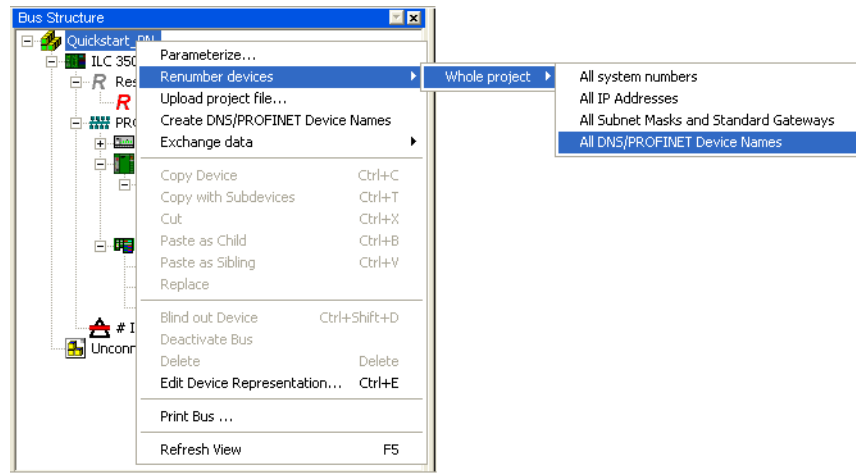

Figure 6-3 Renumbering devices

If, for instance, the PROFINET device names were stored without Domain Postfix, for renumbering the device names are extended to include the Domain Postfix quickstart.de specified in the project node. This is the complete PROFINET device name.

- To view the IP addresses in the bus configuration in ascending order, renumber the IP addresses as well.

All the devices **in the project** now have the correct IP parameters. To assign these parameters **actually** to the device:

- Compile the project, send it to the control system, and perform a cold restart (see "Compiling and transmitting projects, and performing a cold restart" on page 4-12).



6.3 Diagnostics with Diag+

Diag+ is a diagnostic tool for seamless diagnostics of INTERBUS and PROFINET.

When installing PC WorX, Diag+ is installed automatically and is integrated in PC WorX and can be called from PC WorX.

- Start Diag+ via "View, Diag+".

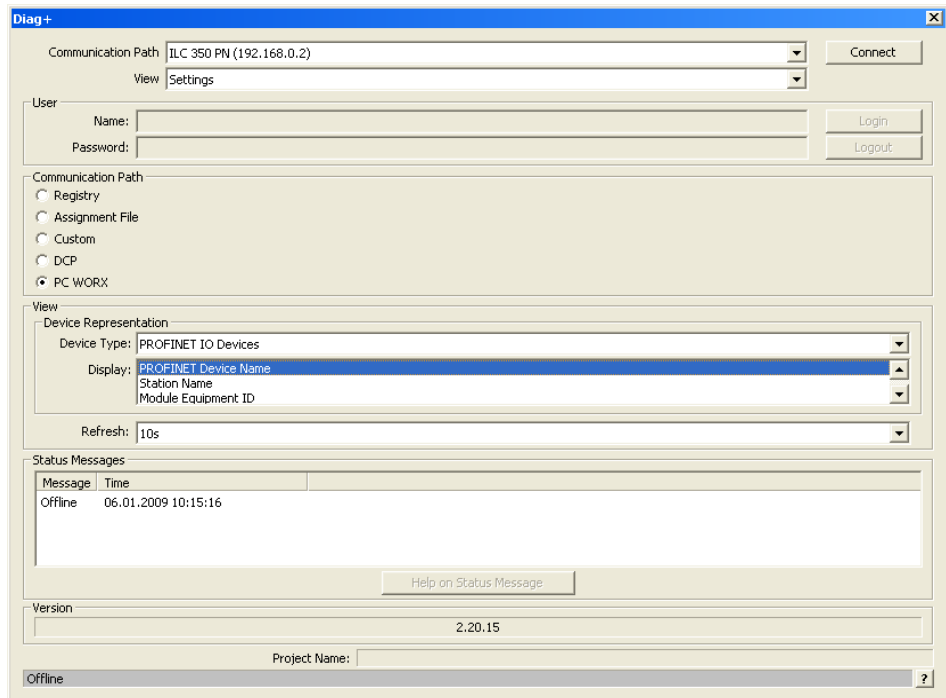

Figure 6-4 Diag+ start screen

- Under "Communication Path", select the device with which you would like to establish a connection.

The diagnostics represented depends on the communication path:

Table 6-1 Possible diagnostics

PROFINET IO controllers	PROFINET IO devices
INTERBUS diagnostics	INTERBUS diagnostics
Diagnostic archive	SNMP messages
PROFINET diagnostics	
Ethernet topology	
SNMP messages	

- Select, e.g., the ILC 350 PN PROFINET IO controller as the communication path.

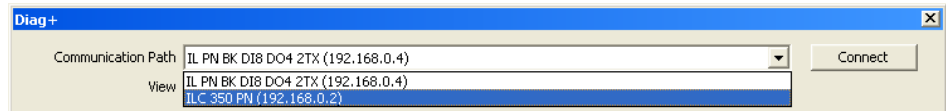

Figure 6-5 Selecting the communication path

- Click on "Connect" to activate the communication path.
- In the "View/Device Representation" section, select which information is to be displayed for the devices. All information marked blue is displayed in the various views.

Device representation view: Display



Figure 6-6 Example for device representation view

View

- At the top of the section under "View", select which information is to be represented.

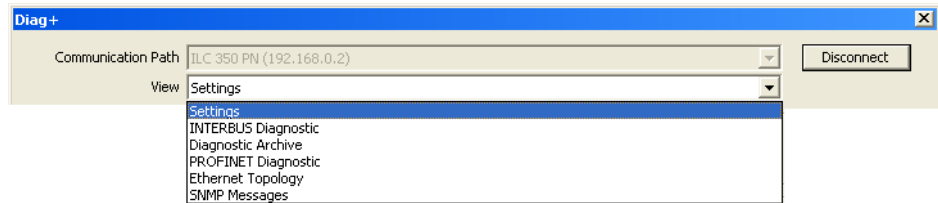

View: INTERBUS Diagnostic

INTERBUS modules in an INTERBUS system can be diagnosed with Diag+ as usual. Various information can be called via the different tabs.

To indicate the functions, the ILC 350 PN communication path changes to IL PN BK DI8 DO4 2TX-PAC here.

- Disconnect the existing communication path by clicking on "Disconnect".
- Select IL PN BK DI8 DO4 2TX-PAC as the new communication path and activate it.

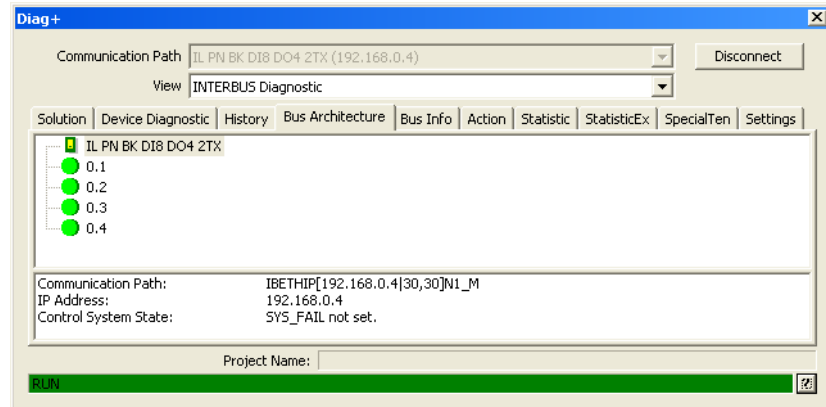

Figure 6-7 INTERBUS Diagnostic: Bus Architecture (no error)

An error is simulated, the IB IL 24 DI 4-ME Inline terminal is disconnected.

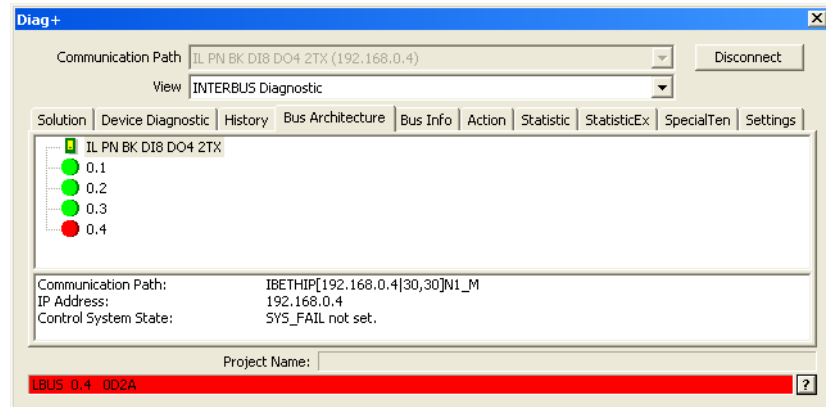

Figure 6-8 INTERBUS Diagnostic: Bus Architecture (error)

- Switch to the "Solution" tab.

Here, information is provided about how to remove the error.

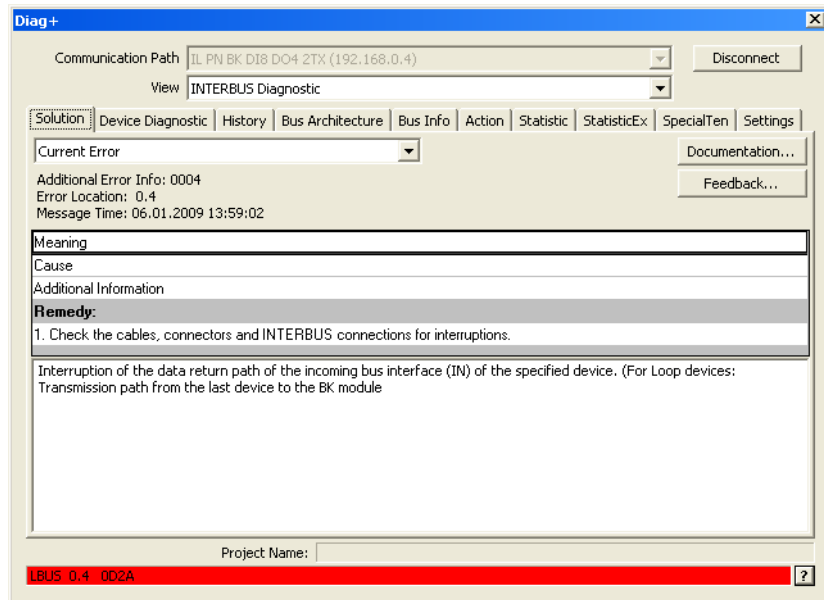

Figure 6-9 INTERBUS Diagnostic: Solution

- Remove the error (here: insert Inline terminal again).

For PROFINET, the entire system is automatically restarted by the PROFINET IO controller.

If the bus is not restarted automatically, the "Action" tab can be used, for example, to acknowledge errors, reset the controller board, and start the bus.

View: Diagnostic Archive

To indicate the functions, the ILC 350 PN communication path is set here.

All events that have occurred are displayed in list format. The display can be adapted to your individual requirements via the filter options at the top of the section.

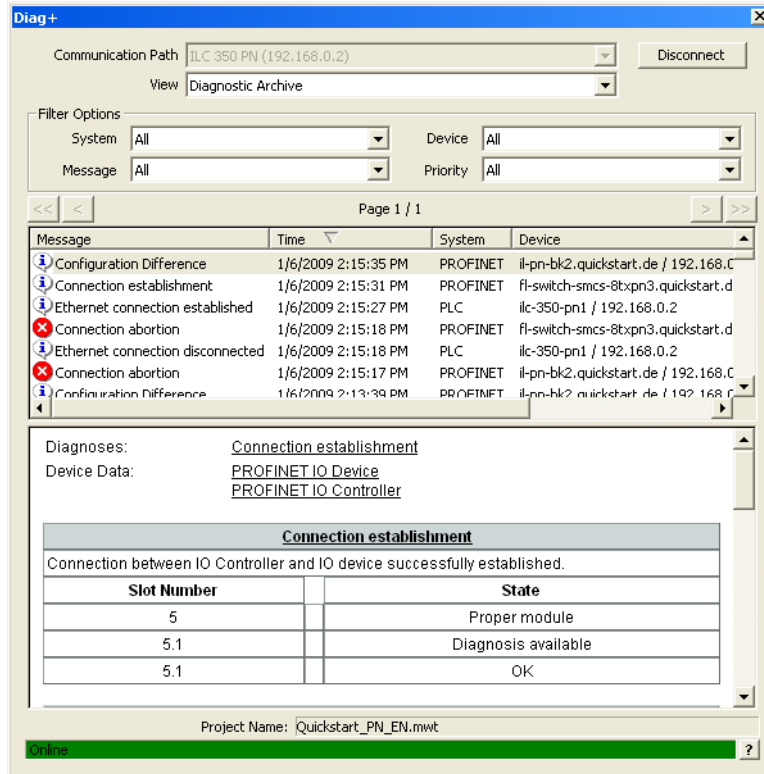

Figure 6-10 Diagnostic archive

**View:
PROFINET Diagnostic**

To indicate the functions, the ILC 350 PN communication path is set here.
Diagnostic information on the PROFINET devices will be displayed.

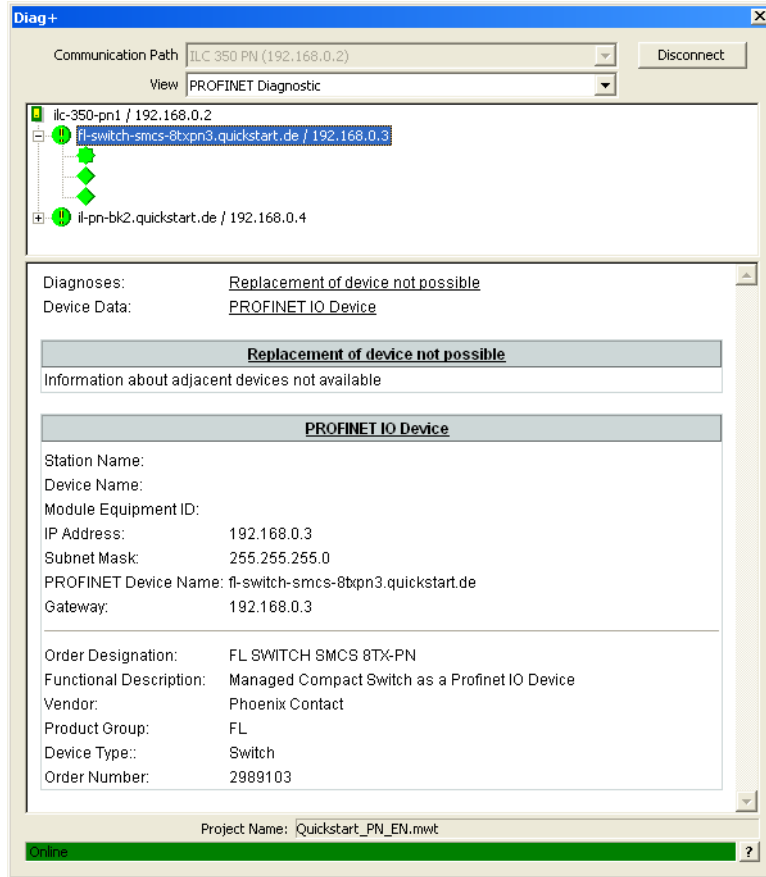

Figure 6-11 PROFINET diagnostics

**View:
Ethernet Topology**

To indicate the functions, the ILC 350 PN communication path is set here.
The complete Ethernet topology will be displayed.

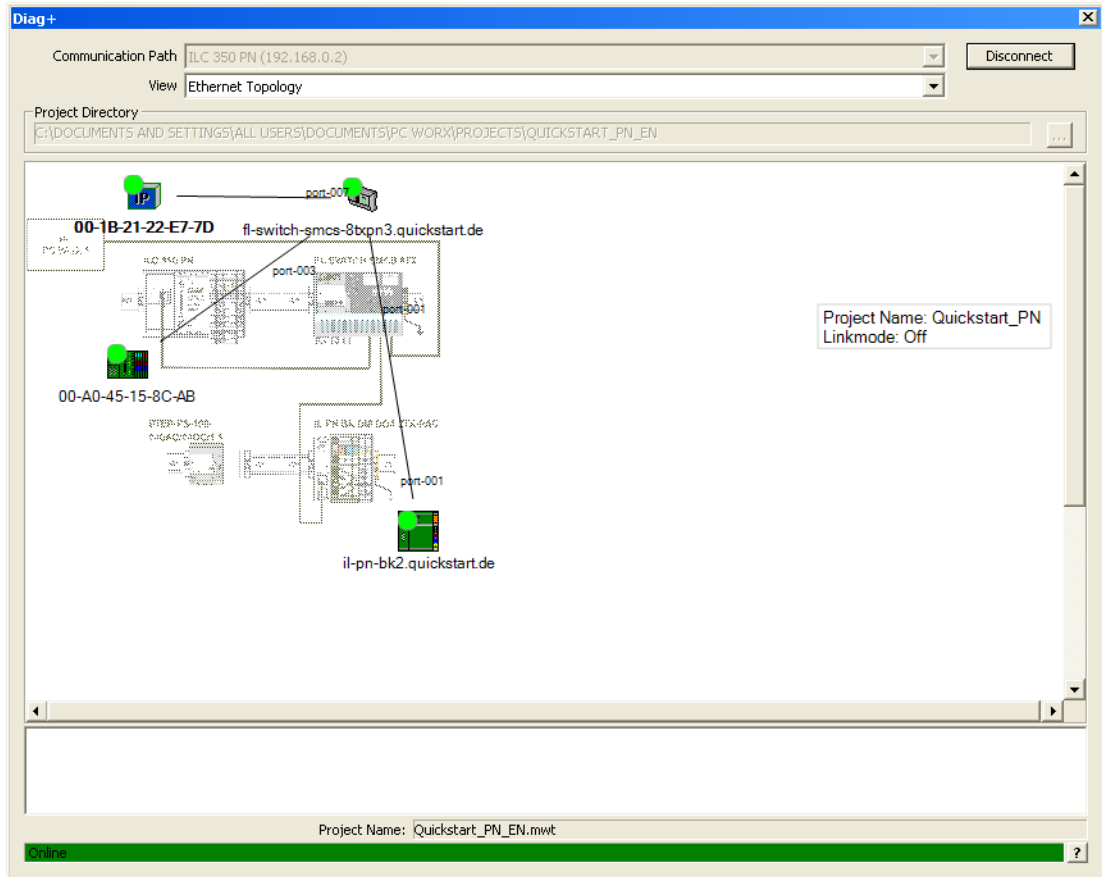

Figure 6-12 Ethernet topology

**View:
SNMP Messages**

SNMP messages are displayed in list format when a WMI provider is available.

6.4 Importing Ethernet devices into the project

You may also import Ethernet devices, such as the programming PC, into your project. This provides you an overview of the complete network.

To import an Ethernet device into the project, proceed as follows:



- Make sure you are in the bus configuration workspace.
- Open the "Universal, Universal, IP" entry in the device catalog.
- If the "Generic IP Device" entry is not present, import this entry. To do this, proceed as follows:
 - Open the context menu for the device catalog.
 - Select the "Import Device" command.
 - In the "...fdcm10\ETHERNET\Universal" folder open the "Generic_IP Devicevxx.xml" file.

The file will be imported into the device catalog.

- Drag and drop the "Generic IP Device" entry into your project.

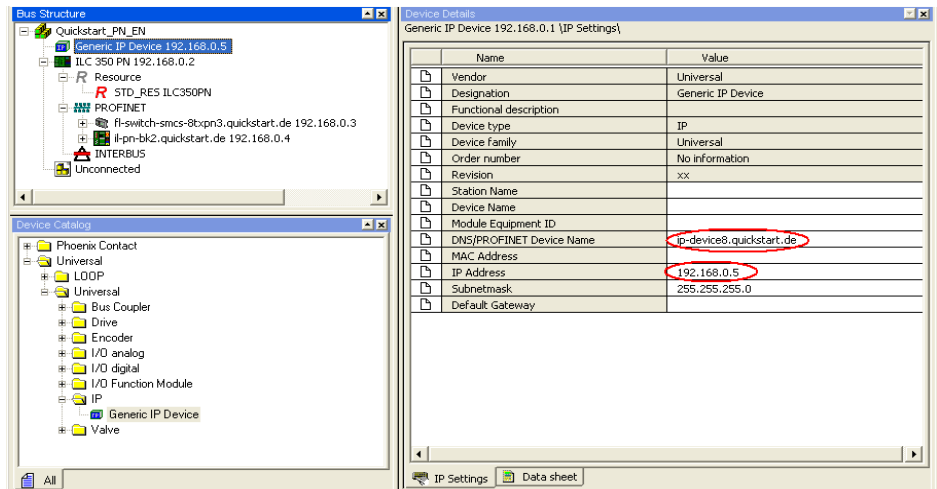

Figure 6-13 Inserting Ethernet devices

The generic device will be inserted with a free IP address and a PROFINET device name.

- Adjust IP address and name under the "IP Settings" tab.

The programming PC is to be inserted in the example. Its IP address is 192.168.0.1.

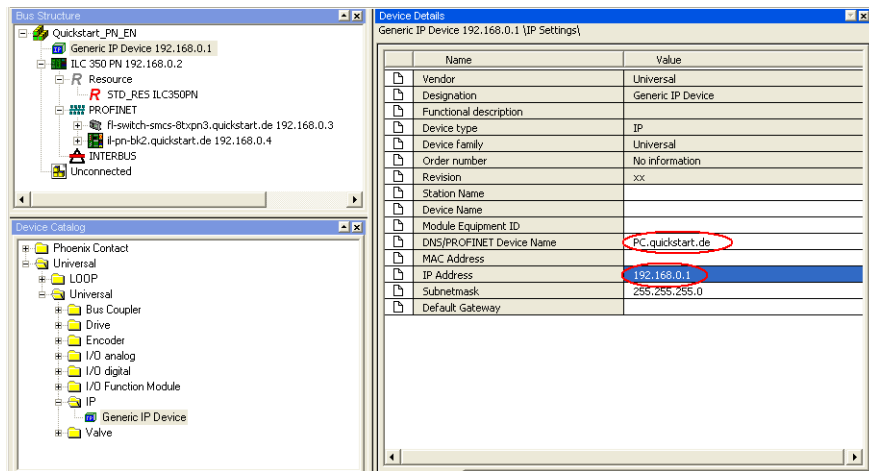

Figure 6-14 Adjusting IP address and PROFINET device name

- Compile the project, send it to the control system, and perform a cold restart (see "Compiling and transmitting projects, and performing a cold restart" on page 4-12).

6.5 Detecting Ethernet topologies

PC WorX can be used to automatically detect Ethernet topologies. All the Ethernet devices in the project can be displayed with connections in the "Ethernet Topology" window. For all devices with LLDP functions, the connections are displayed automatically with the port number.



Ethernet devices may also be displayed in the topology view. However, you must have inserted this device (see "Importing Ethernet devices into the project" on page 6-12).

The other functions are explained in the example. A complete bus configuration is required.

- Open the window via "View, Ethernet Topology".
- In the "Ethernet Topology" window, select "Topology, Refresh" in the context menu.

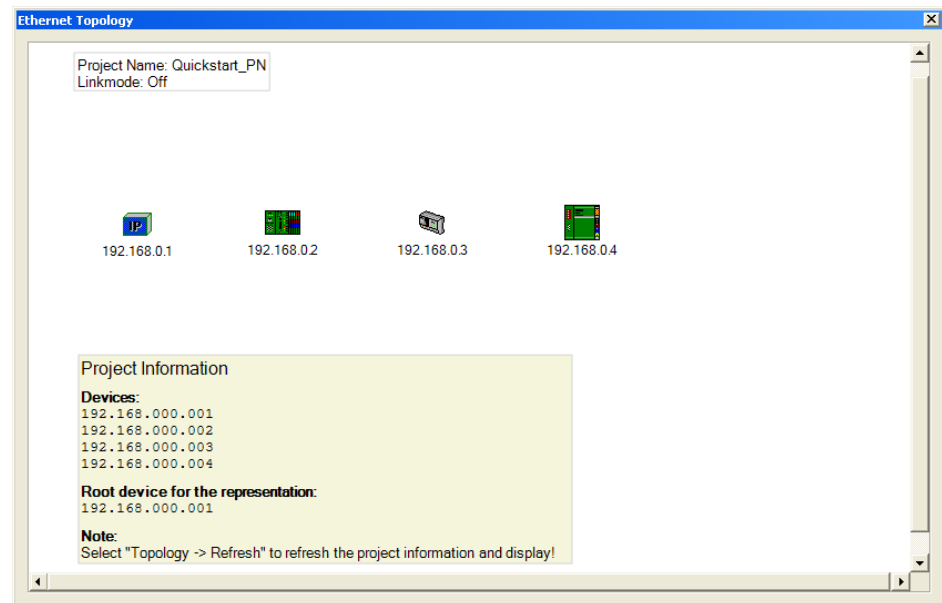

Figure 6-15 Refreshing the topology for the first time

A device must now be selected as the starting point for the representation. Since connections are only automatically created between devices with LLDP functions, it is useful to select this type of device.

- Double-click on the PC, for instance.

Starting point for the representation

- Activate the "Use device as root element of representation" option in the window that opens.

The screenshot shows the 'Device Properties' dialog box with the 'General' tab selected. The 'Information' section contains the following fields and values:

Field	Value
IP Address:	192.168.0.1
DNS/PROFINET Device Name:	PC.quickstart.de
Station Name:	
Device Name:	
Module Equipment ID:	
Vendor Name:	Universal
Order Number:	keine Angaben
Order Designation:	IP Universalteilnehmer
Chassis ID:	00-1B-21-22-E7-7D
MAC Address:	00-1B-21-22-E7-7D
Firmware Version:	not available
Additional Information:	

The 'Setting' section contains a checked checkbox for 'Use device as root element of representation' and a note: 'Change will take effect only after next refresh command!'. 'OK' and 'Cancel' buttons are at the bottom.

Figure 6-16 Specifying the starting point for the representation

- Confirm your selection with "OK".

Show accessibility

- In the context menu select "Online View, Show Accessibility" to display the status of the connections.

All devices that can be accessed are highlighted with a green dot.

- Refresh the representation via the "Topology, Refresh" context menu.

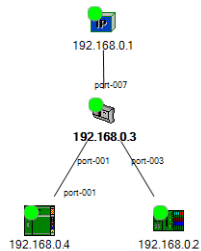

Figure 6-17 Topology with automatically detected connections

Connection mode

If not all connections are displayed, proceed as follows to display the remaining connections as well:

- In the context menu for the window select "Edit, Link Mode".
- Press and hold down the mouse button over a device and draw a line to the device it is connected to.
- Repeat this step for all connections.

Settings

To create a visual assignment between the icons and the actual system, an image can be placed in the background.

- Create an image and place it in the relevant directory on your PC.
- In the context menu for the window open "Topology, Settings".
- Open the "Background Image" tab.
- Import the image.
- Select the image under "Settings".
- Adjust the transparency and zoom.

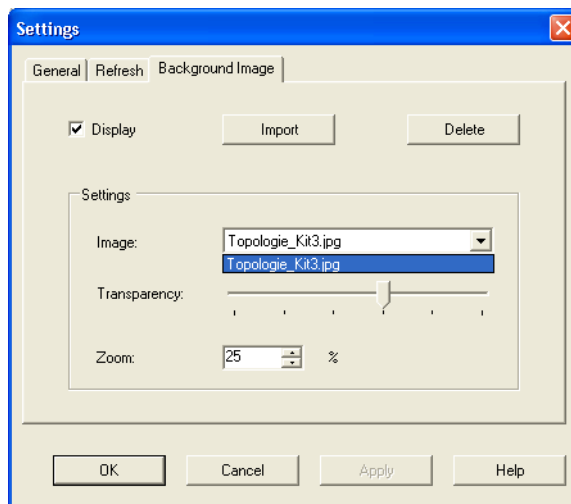

Figure 6-18 Settings for the background image

- Confirm your settings with "Apply" and "OK".
- Set the link mode to OFF ("Edit, Link Mode" in the context menu).
- Position the icons on the image.

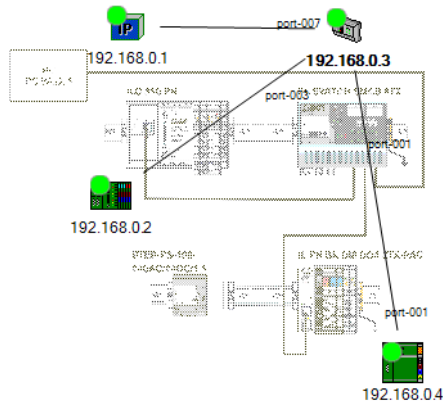

Figure 6-19 Devices in the system

Further options:

- The device context menu can be used to open the web interface of the device (if present; e.g., for the switch).
- The window context menu and the device context menu can be used to make various settings.
- The connection information is displayed by double-clicking on an automatically created connection or a port number.
- The window context menu ("Topology, Print...") can be used to print the topology.
- Connection errors are displayed once the view is refreshed.

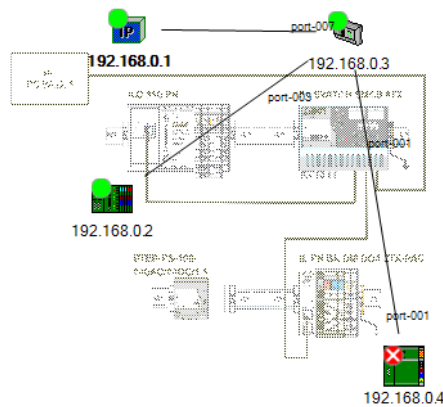

Figure 6-20 Topology with connection error

Options for refreshing the topology:

- F5 function key
- Manual refresh via the context menu of the "Ethernet Topology" window "Topology, Refresh".
- Automatic refresh according to the predefined refresh time.

Specify the time for automatic refresh as follows:

- Open the context menu for the "Ethernet Topology" window.
- Select "Topology, Settings...".
- Select the "Refresh" tab.
- Activate the "Cyclic Refresh" checkbox and set a "Spacing".

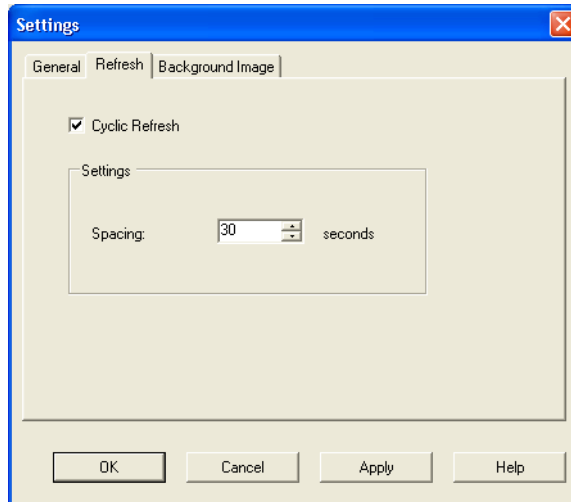

Figure 6-21 Specifying the time for refreshing the topology

6.6 Device description files

Device description files are FDCML or GSD files, which provide a complete description of a device. If the device catalog does not contain a corresponding device description file, it must be imported.

6.6.1 Phoenix Contact device description files

When PC WorX is reinstalled, the device description files for the devices available at the time are also installed. These descriptions are also found in the device catalog. When installing PC WorX service packs, new device description files are installed in folder **...\FDCML10...\Phoenix Contact**. These new descriptions are not included in the device catalog yet. They must be imported where necessary.

- Select "Phoenix Contact" in the "Device Catalog" window in PC WorX.
- Open the context menu and select "Import Device...".

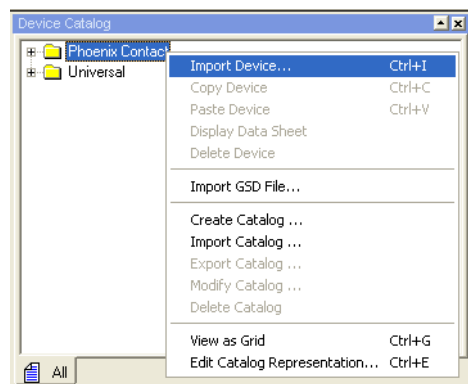

Figure 6-22 Device catalog: Import device

- Select the device description file. If you have used the suggested standard installation when you installed PC WorX for the first time, the files are located in the directory **C:\Documents and Settings\All Users\Documents\FDCML10\xxx\Phoenix Contact**.
xxx = System (e.g., ETHERNET, INTERBUS, PROFINET)

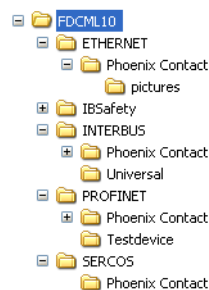

Figure 6-23 Directory for the device description files

- Confirm your selection.

The message window indicates whether the device has been imported successfully.



If a device description file is not available, one can be created. For this, a device description editor is included on the AUTOMATIONWORX Software Suite CD.

6.6.2 Device description files from other manufacturers (GSD files)

GSD files can be used to integrate devices from manufacturers other than Phoenix Contact in PC WorX.

- Copy the GSD file for your device, e.g., from the Internet to your PC hard disk.
- Select "Phoenix Contact" in the "Device Catalog" window in PC WorX.
- Open the context menu and select "Import GSD File..."

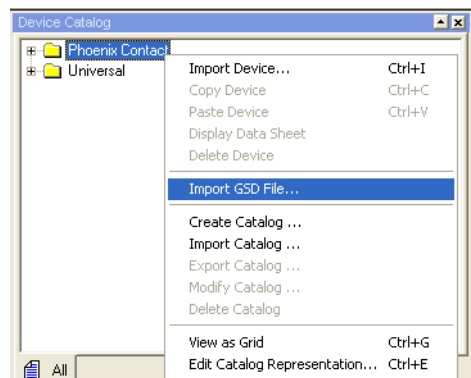

Figure 6-24 Device catalog: Import GSD file

- Select the device description file and confirm with "Open".

PC WorX creates an entry for the device in the device catalog. You will find the entry in the ...\\FDCML10\\... directory.

The message window indicates whether the device has been imported successfully.

When reading a modular device, only the device, and not its modules, is displayed in the bus configuration.

Manually insert the modules for these devices. To do this, proceed as follows:

- Open the module catalog via "View, Module Catalog..."
- Select the device modules one at a time from the module catalog and drag and drop them in the lower level below the device entry.

A Appendix: Status information and system variables

A 1 Configuration status of the PROFINET IO controller

The PROFINET IO controller has status information that indicates its configuration status. This can be requested via the "PNIO_CONFIG_STATUS" system variable. The system variable is available as a word and as individual bits under "Global_Variables".

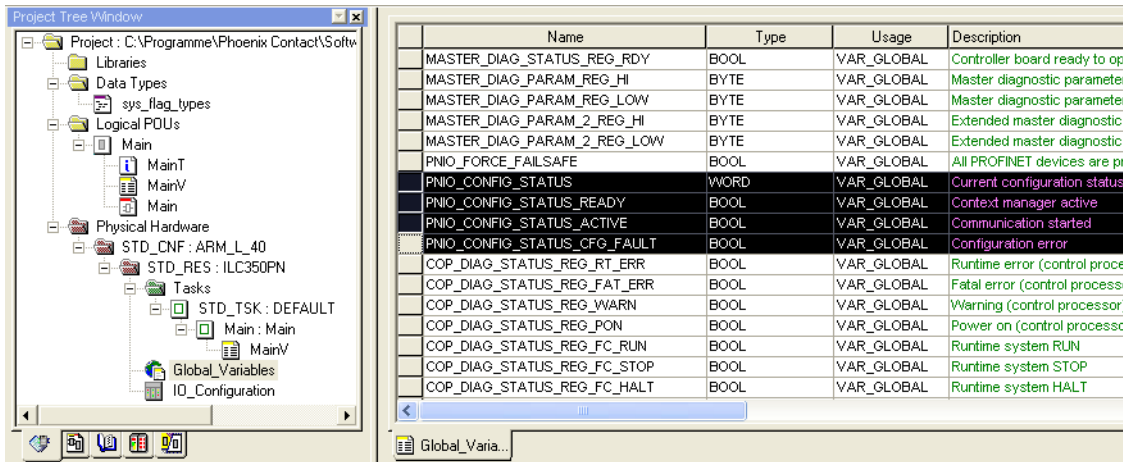

Figure A-1 PNIO_CONFIG_STATUS system variable

PNIO_CONFIG_STATUS_READY

The variable is set if the PROFINET IO controller has been initialized correctly. No desired configuration has been loaded by PC WorX yet.

PNIO_CONFIG_STATUS_ACTIVE

The variable is set if the desired configuration for the PROFINET IO controller has been loaded. In this state the PROFINET IO controller attempts to establish a connection cyclically to all devices in the desired configuration (under the PROFINET icon). In this way, it attempts to find each device with the corresponding "PROFINET device name" in the current sub network.

If the connection to a PROFINET IO device has been established successfully, the corresponding "PNIO_DATA_VALID" process data item is set.

For devices that cannot be accessed, the PROFINET IO controller repeatedly attempts to establish a connection cyclically in intervals of approximately 5 ms.

A connection cannot be established, e.g., if the corresponding device is ready, but a correct PROFINET device name has not yet been assigned to it.

PNIO_CONFIG_STATUS_FAULT

This system variable is set if an error occurred when configuring the PROFINET IO controller.

A 2 Status of a PROFINET IO device

The status of a PROFINET IO device can be requested using predefined process data. The "~PNIO_DATA_STATE" byte that contains corresponding status bits is available. A PROFINET IO device only provides valid data if this bit is set.

PNIO_DATA_VALID

For PROFINET IO, it may be normal during operation that a PROFINET IO device within the network cannot be accessed (e.g., undocking devices).

Use this variable to specify for your application whether or not the operation of all other PROFINET IO devices is to be continued despite a device failure.

In both cases the application program must receive information on whether a PROFINET IO device is supplying valid data or not. This is why each PROFINET IO device has a "PNIO_DATA_VALID" process data item.

Only if this bit is set does the PROFINET IO device supply valid data and all other process values are valid.

PNIO_IS_PRIMARY

This process data item is reserved for future redundancy functions.

PNIO_APPL_RUN

This bit indicates that the application is running on the PROFINET IO device.

PNIO_NO_DIAG

If this bit is set, no device diagnostics is present.



Not all bits of the "~PNIO_DATA_STATE" byte are used. To prevent unused bits being used by mistake, hide them in the control program by linking to a corresponding bit mask.



If variables were previously created and system variables are to be assigned, the procedure is the same as that for assigning user variables (see Section "Assigning process data" on page 5-24).

A 3 PNIO_FORCE_FAILSAFE system variable

In many cases, a machine/system can no longer be operated in the event of a PROFINET IO device failure. This is a standard situation in modern INTERBUS systems where neither bus couplers nor isolated disconnection are used.

In the example system, a PROFINET IO device failure does not affect the operation of all the other PROFINET IO devices. If you would like to set all outputs to a safe state in the event of an error, the "PNIO_FORCE_FAILSAFE" system variable can be used. It can be found in the IEC programming workspace under "Global_Variables".

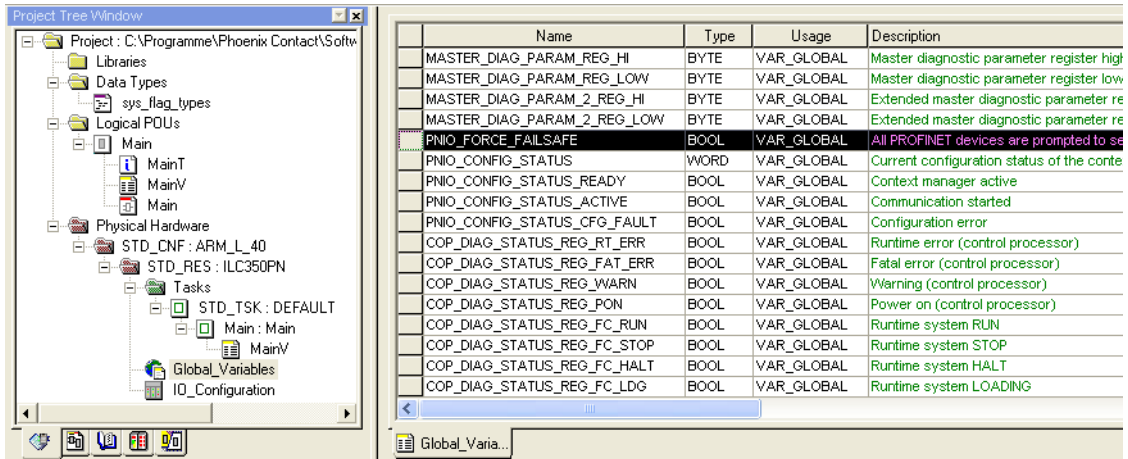

Figure A-2 PNIO_FORCE_FAILSAFE system variable

If the variable is set, all the PROFINET IO devices output zero points or defined substitute values. The corresponding inputs are set to zero.

