

## NCP1034 Buck Converter Evaluation Board User's Manual



ON Semiconductor®

[www.onsemi.com](http://www.onsemi.com)

### EVAl BOARD USER'S MANUAL

Table 1. GENERAL PARAMETERS

Device	Input Voltage	Output Voltage	Output Current	Voltage Ripple	Topology	I/O Isolation
NCP1034	48 V ±20%	5 V	5 A	< 30 mV	Buck	None

#### Description

This evaluation board user's manual describes high voltage, high power and high efficiency DC/DC buck converter featuring the NCP1034.

The NCP1034 is voltage mode PWM controller for a high voltage synchronous buck. The controller drives two external N-MOSFETs with programmable frequency up to 500 kHz for wide applications range. The IC is able to be synchronized by external signal or is able to synchronize other ICs that simplify design of system level filter. The output voltage can be set as low as 1.25 V. Besides system and drivers UVLO there is an external UVLO that can be set to user value. Over current protection uses low side MOSFET  $R_{DS(ON)}$  as sensing resistor, which has no impact on efficiency. Current limit protection uses a hiccup mode. These protections provide application additional security level.

#### Key Features

- High Input Voltage
- High Operation Frequency
- High Efficiency
- Low Output Voltage Ripple
- Ceramic Capacitors Only
- Over-current Protection
- Under-voltage Protection
- Start to Pre-biased Output
- Small Size

#### Connection Diagram

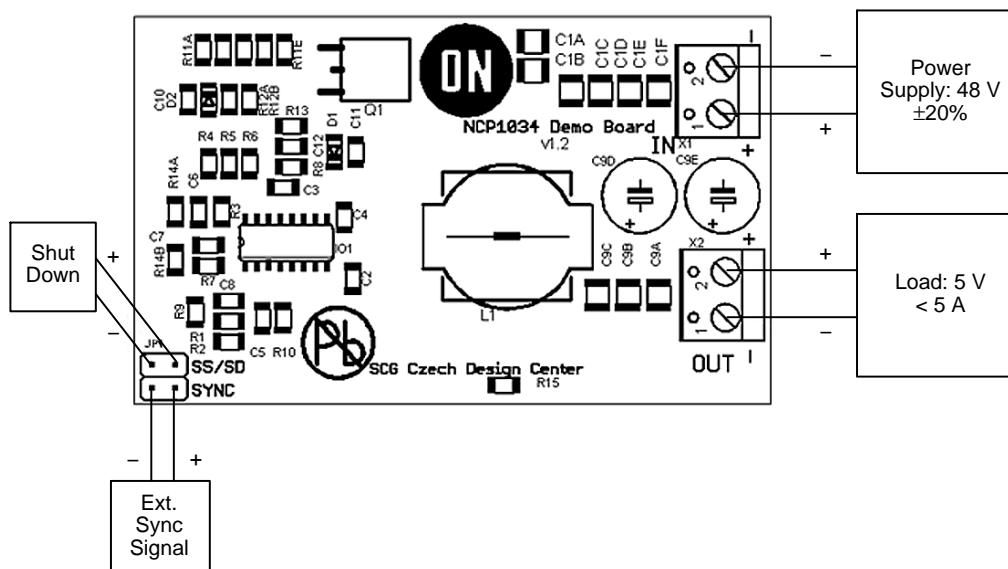

Figure 1. Connection Diagram



The demo board was designed as board with many options. There is linear regulator for powering the IC only with Zener diode or with high voltage transistor (R12A and R12B selected one of these regulators), compensation circuit of second or third type (R14A and R14B), ceramic or electrolytic output capacitors (C9A–C9E) and various input capacity (C1A–C1F). For additional filtering there are R13 and C11 which is not currently used. There are two headers pins for easy connection to external synchronization pulse source or to direct connection to the other NCP1034 demo board and the SS/SD pin that can be used to shut down the controller by connecting it to the ground.

**Circuit Layout**

Circuit is designed on two layer FR4 board with 72 μm copper cladding. Except connectors all components are

surface mounted types and almost all of them are on the top layer. On the bottom side there are power MOSFETs because it can be easy put on cooler (if demo board is used on prescribed operations conditions and at room temperature it is not needed).

Some components must be placed very carefully. Blocking capacitors C2, C3 and bootstrap capacitor C4 have to be placed close to the IC. Low side MOSFET's source have to be connected to the IC's power ground with minimum resistance and inductance of connection so two layers connection between them is needed. Feedback and compensation network should be near the IC to minimize noise on them. Using signal and power ground connected in one point near the output connector improves load regulation. Inductor and output capacitors are placed close to the MOSFETs and output connector.

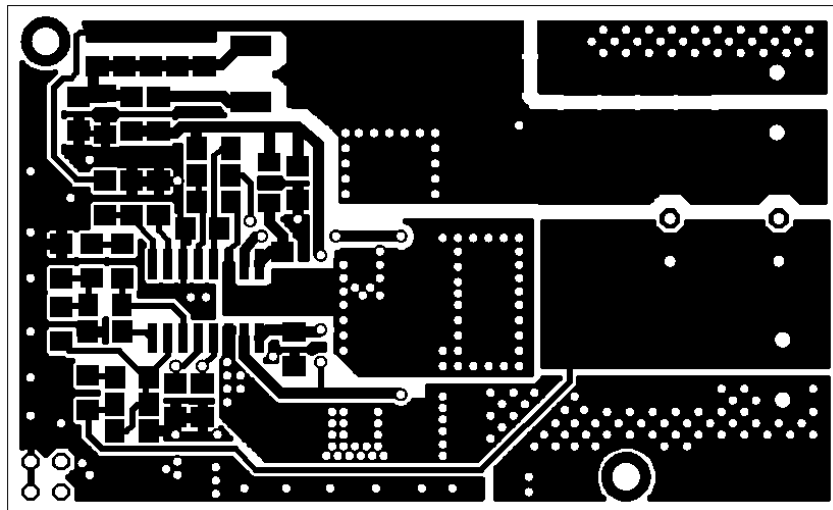

Figure 3. Top Layer

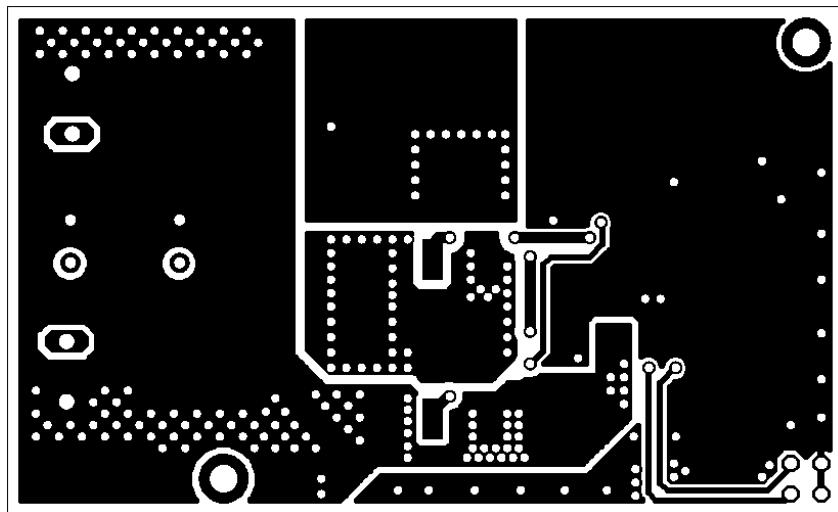

Figure 4. Bottom Layer

# EVBUM2356/D

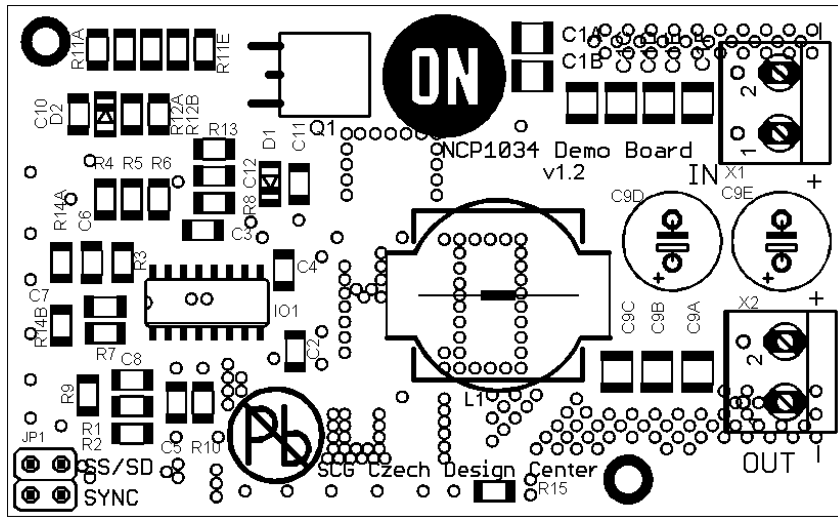

Figure 5. Top Side Components

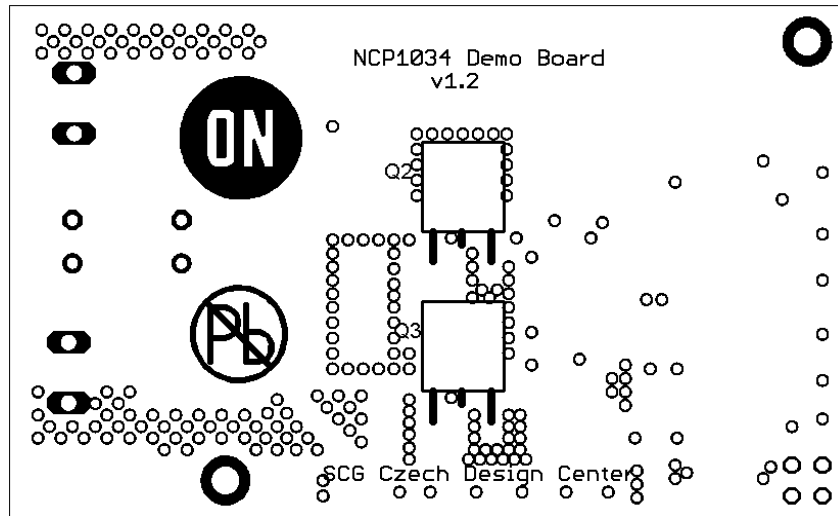

Figure 6. Bottom Side Components

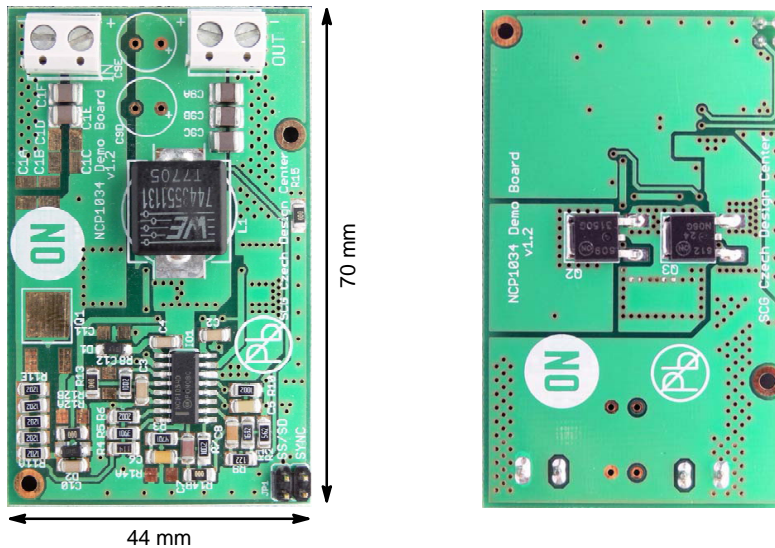

Figure 7. Demo Board Photos

Measurement

Table 2. OUTPUT PARAMETERS

Characteristic	Typ	Unit
Output Voltage	5.02	V
Maximum Output Current	5	A
Oscillator Frequency	200	kHz
Output Voltage Ripple $I_{OUT} = 0.1\text{ A}$ $I_{OUT} = 5\text{ A}$	16.5 20.5	$\text{mV}_{\text{pk-pk}}$
Load Regulation $I_{OUT} = 0\text{--}5\text{ A}, V_{IN} = 48\text{ A}$	-0.34	$\text{mV/A}$
Line Regulation $V_{IN} = 38\text{--}58\text{ A}$ $I_{OUT} = 0.1\text{ A}$ $I_{OUT} = 5\text{ A}$	0.004 0.011	%

Start Up Sequence

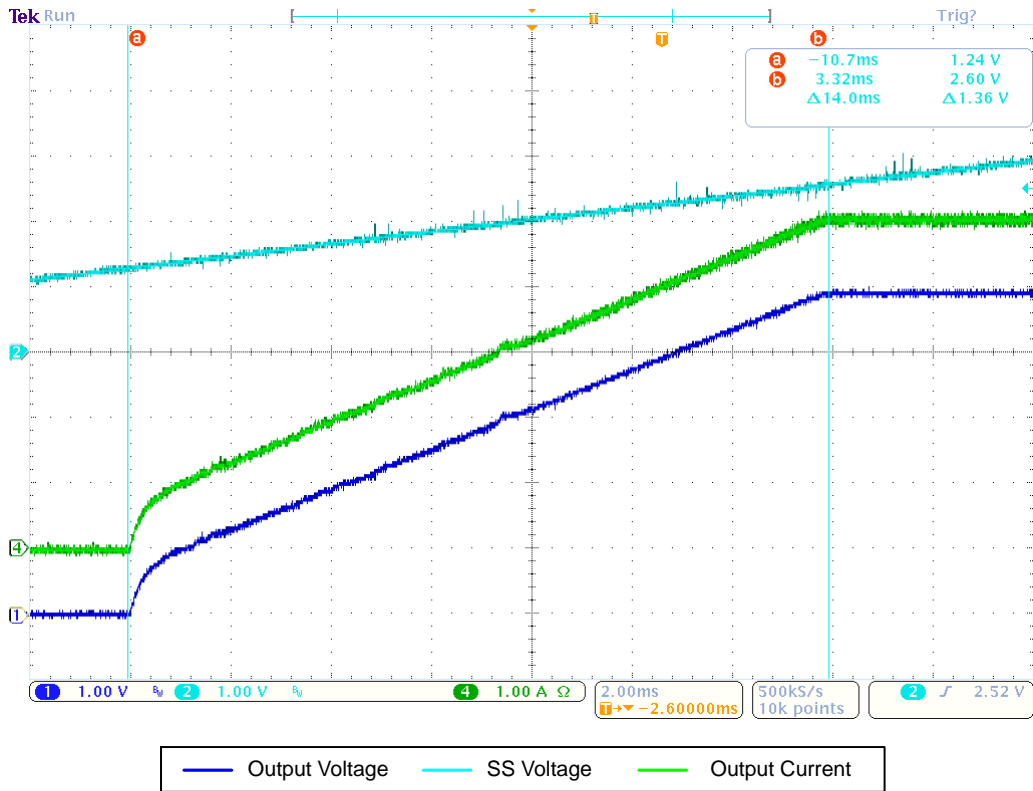

Figure 8. Start to Nominal Load

# EVBUM2356/D

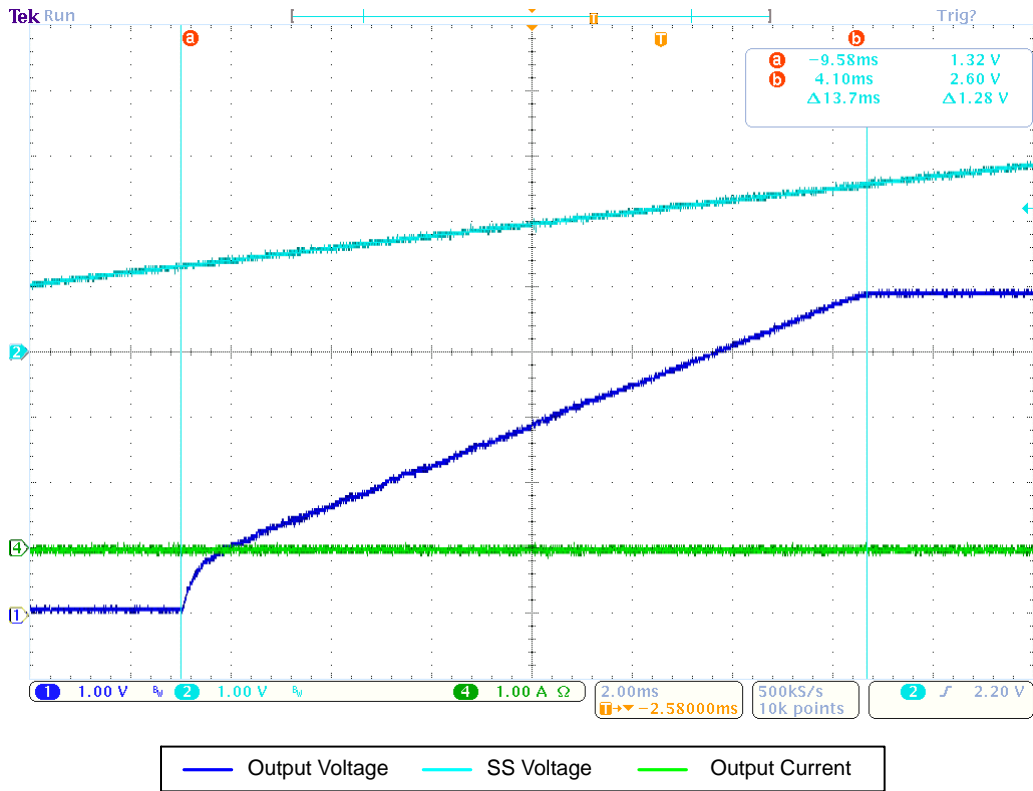

Figure 9. Start to Light Load

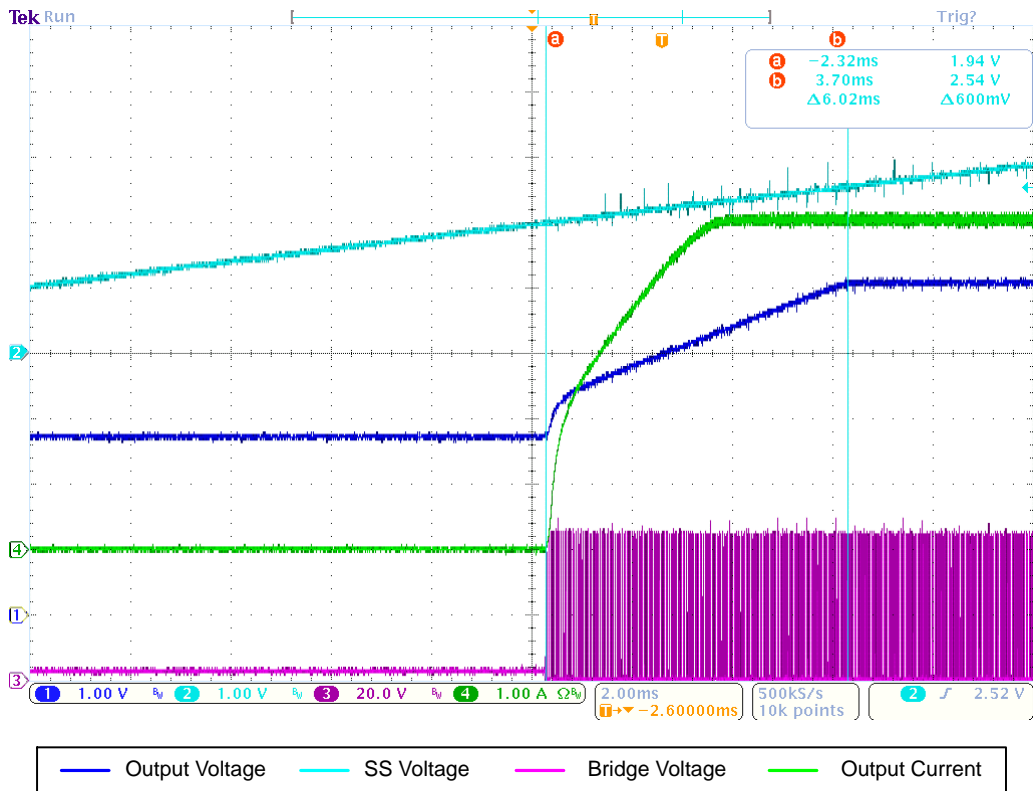

Figure 10. Start to Pre-Biased Output

Over-Current Protection

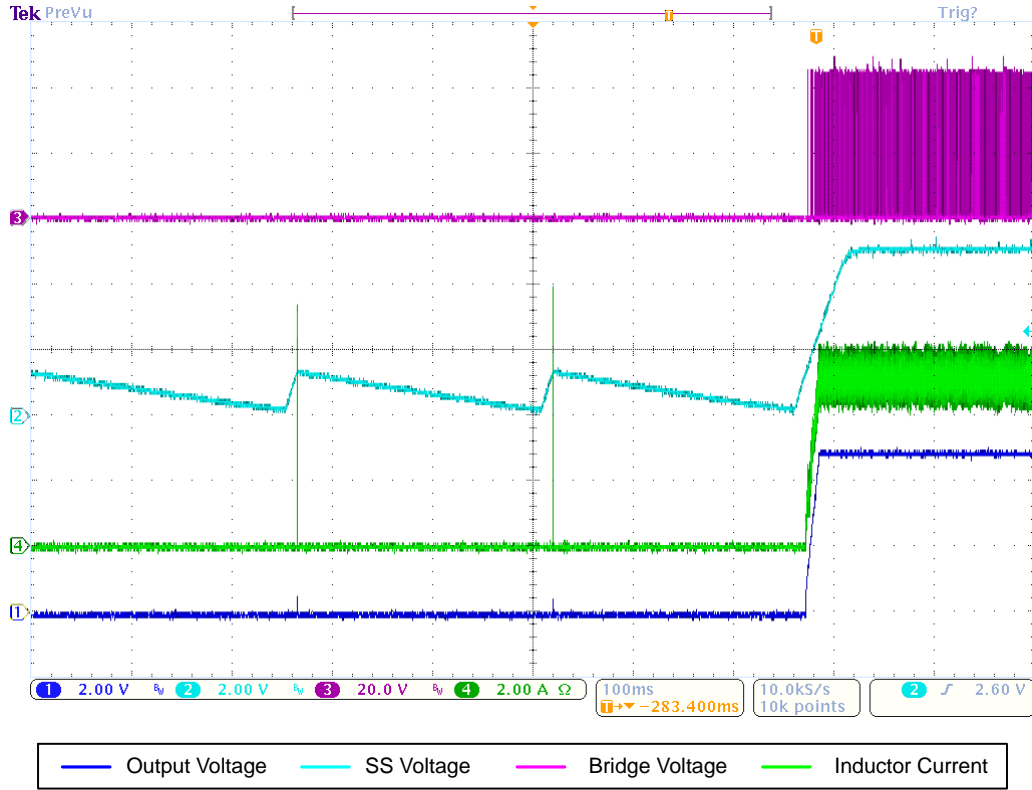

Figure 11. Shorted Output and Release

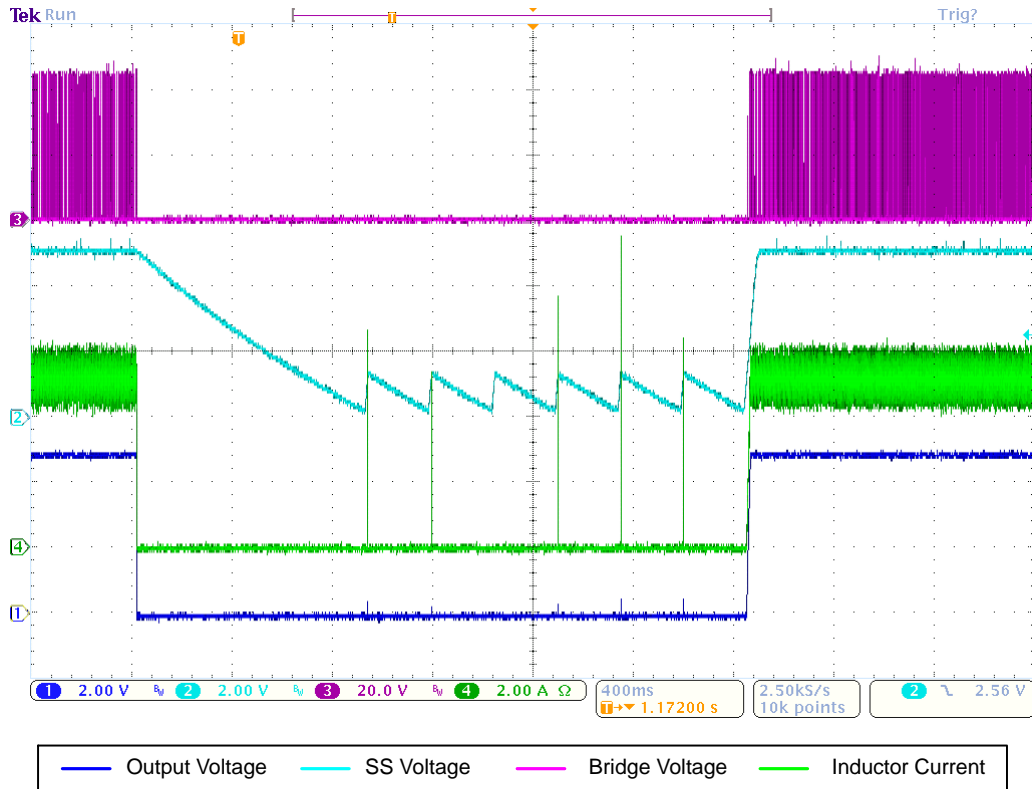

Figure 12. Overload from Nominal Load and Released

# EVBUM2356/D

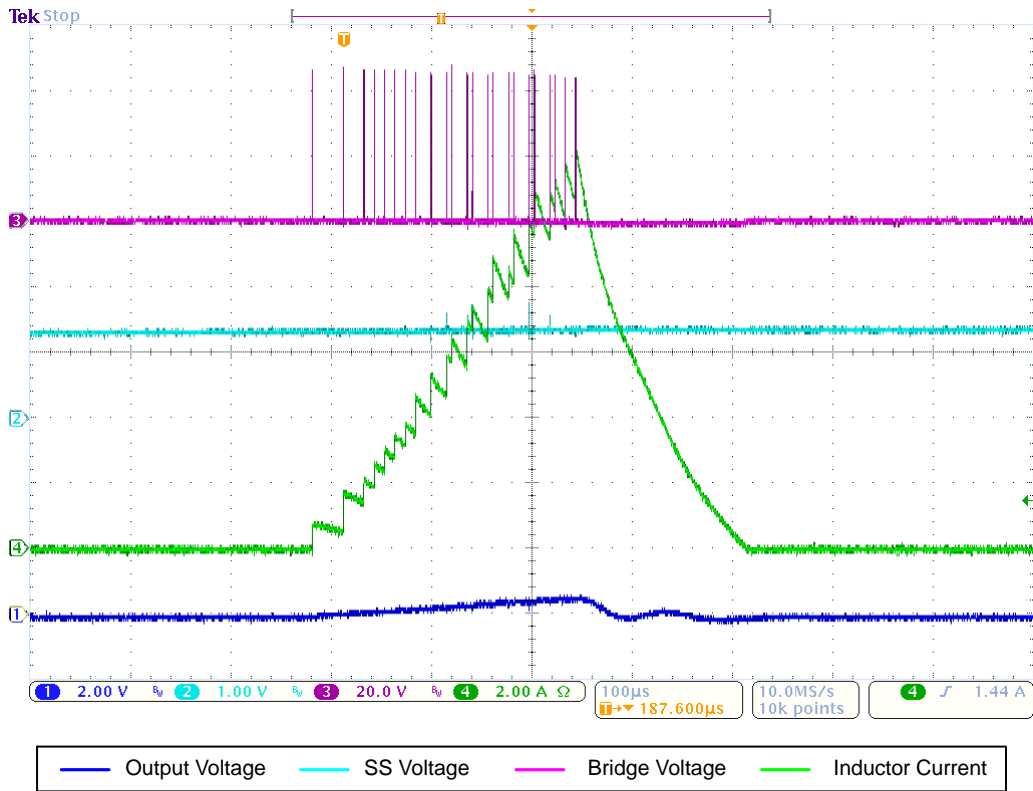

Figure 13. Hiccup Pulse Detail

## Shutdown

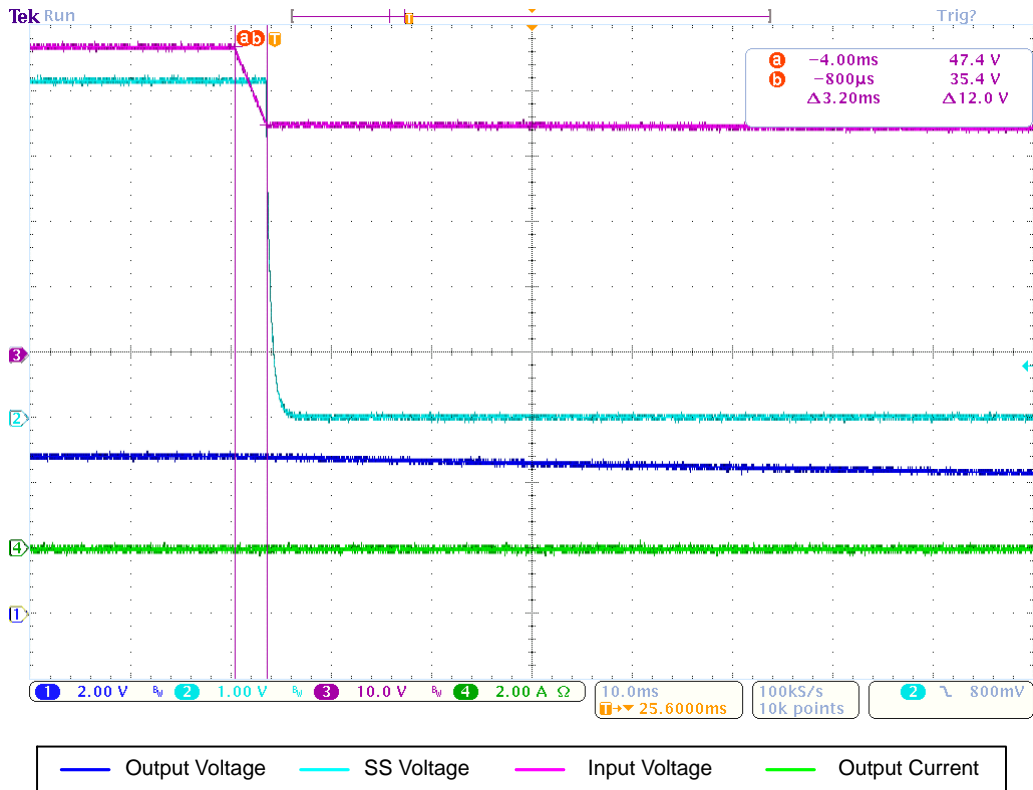

Figure 14. Switch Off Input Voltage to Light Load



# EVBUM2356/D

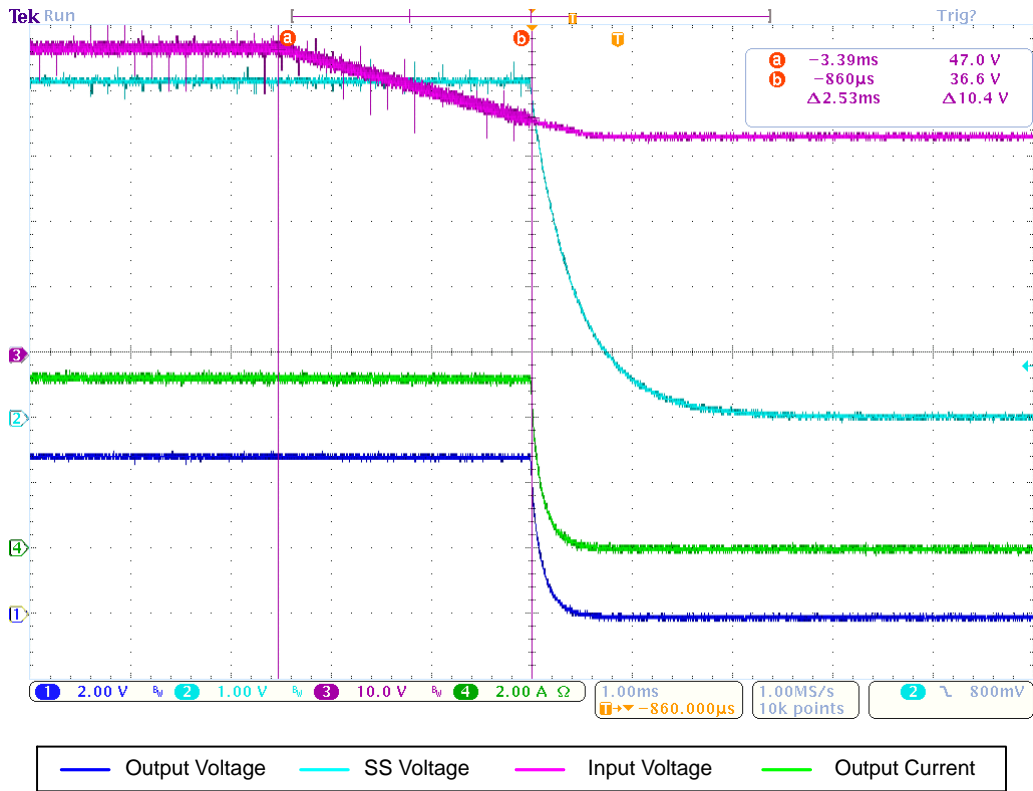

Figure 15. Switch Off Input Voltage to Nominal Load

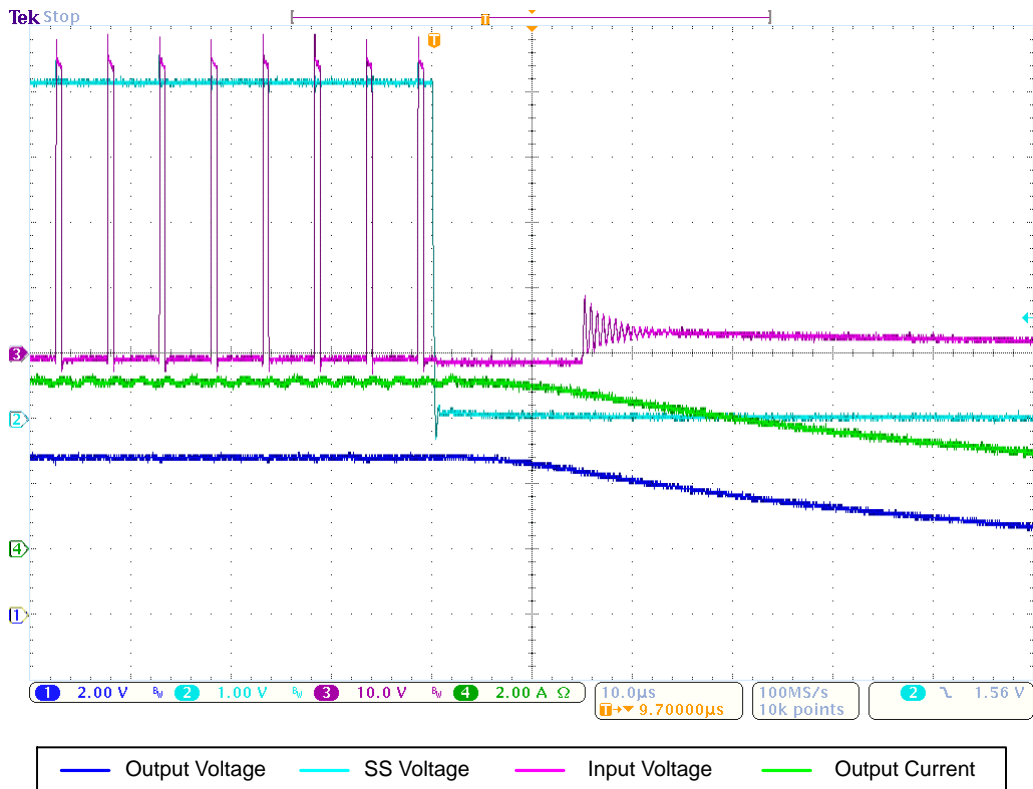

Figure 16. Shut Down through SS/SD Pin

Step Response and Output Voltage Ripple

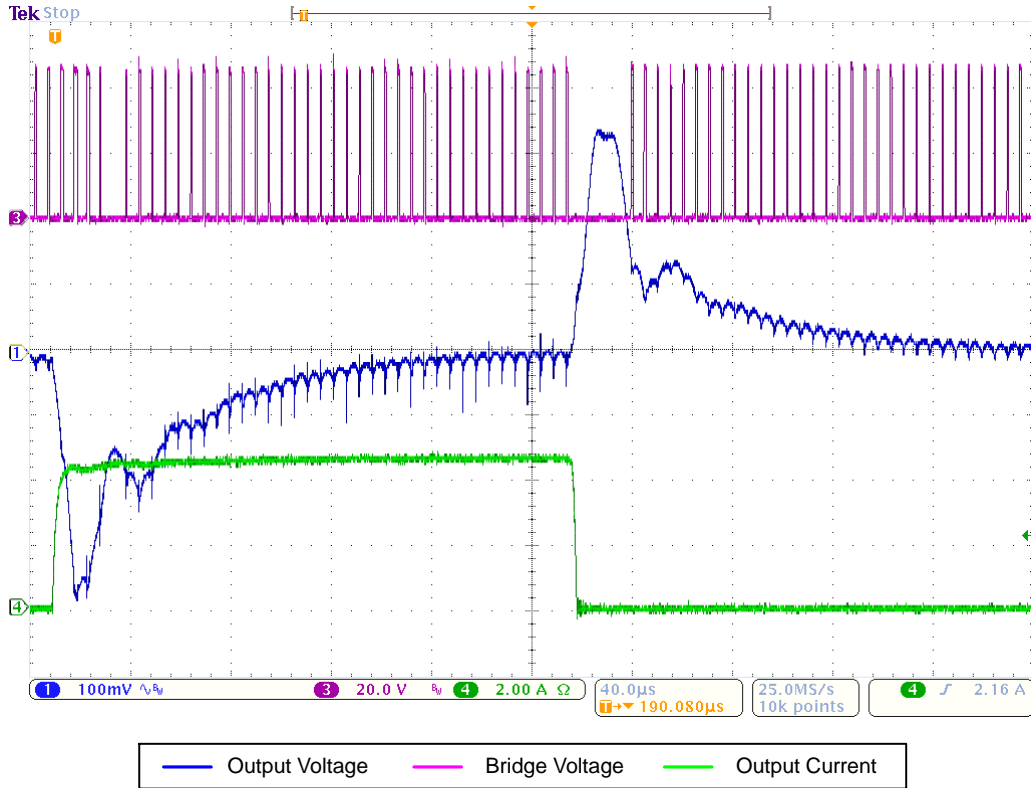

Figure 17. Load Step Response

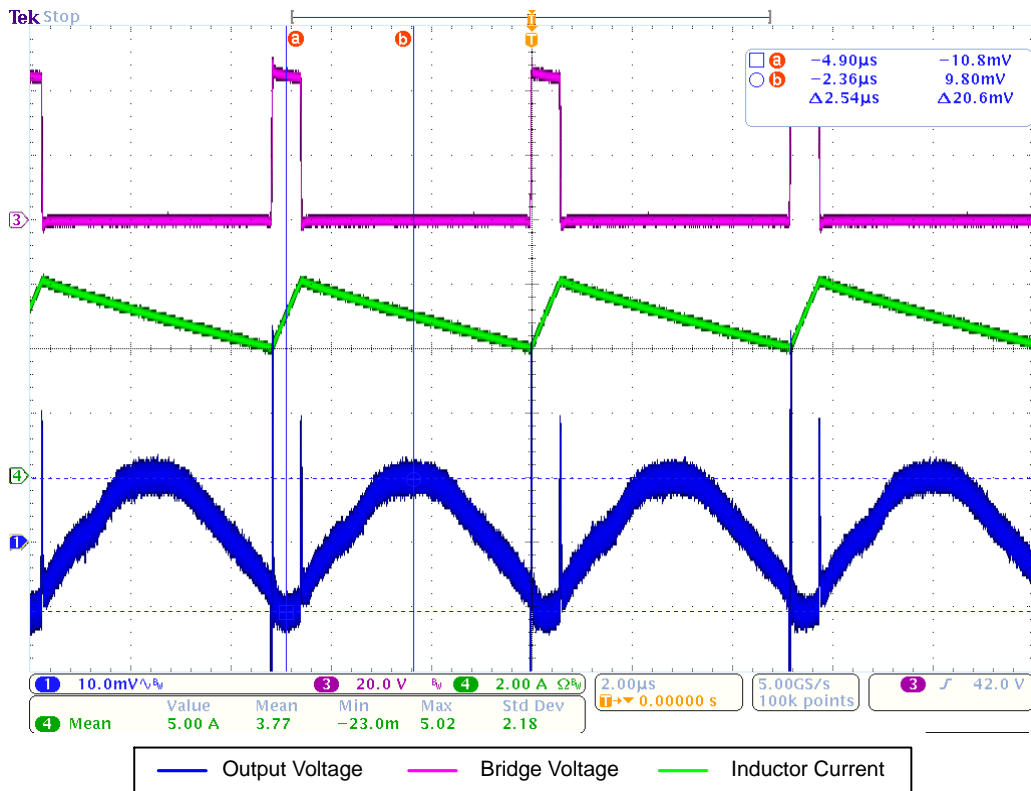

Figure 18. Output Voltage Ripple  $I_{OUT} = 5 A$

# EVBUM2356/D

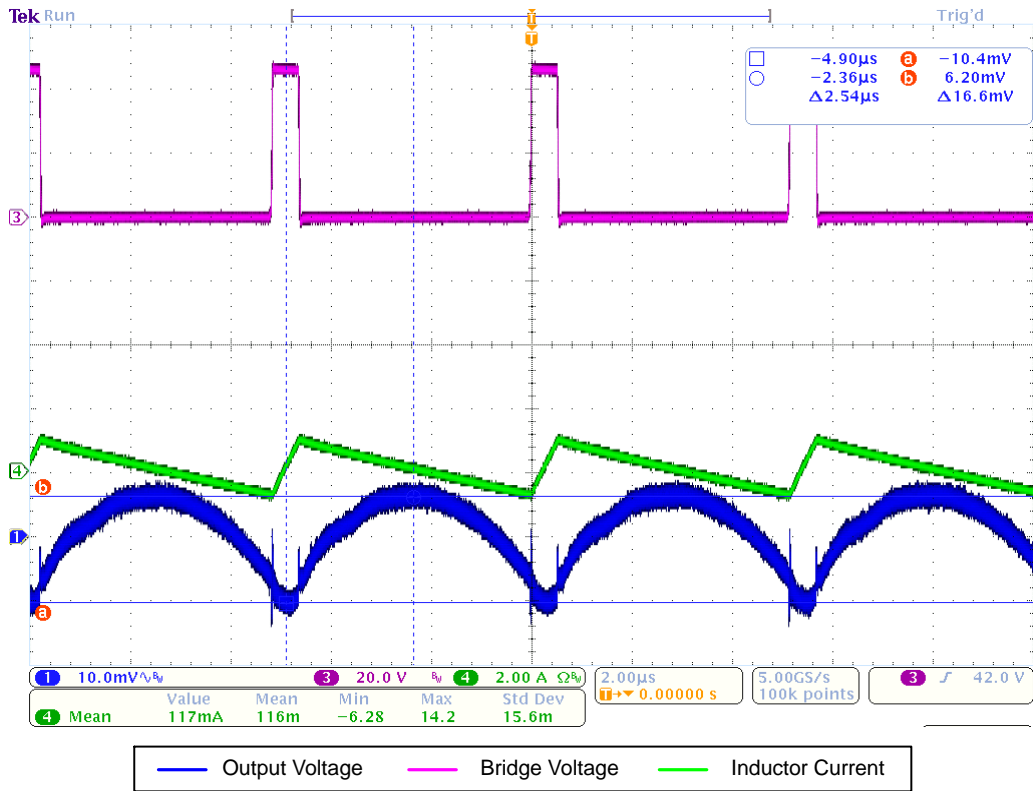
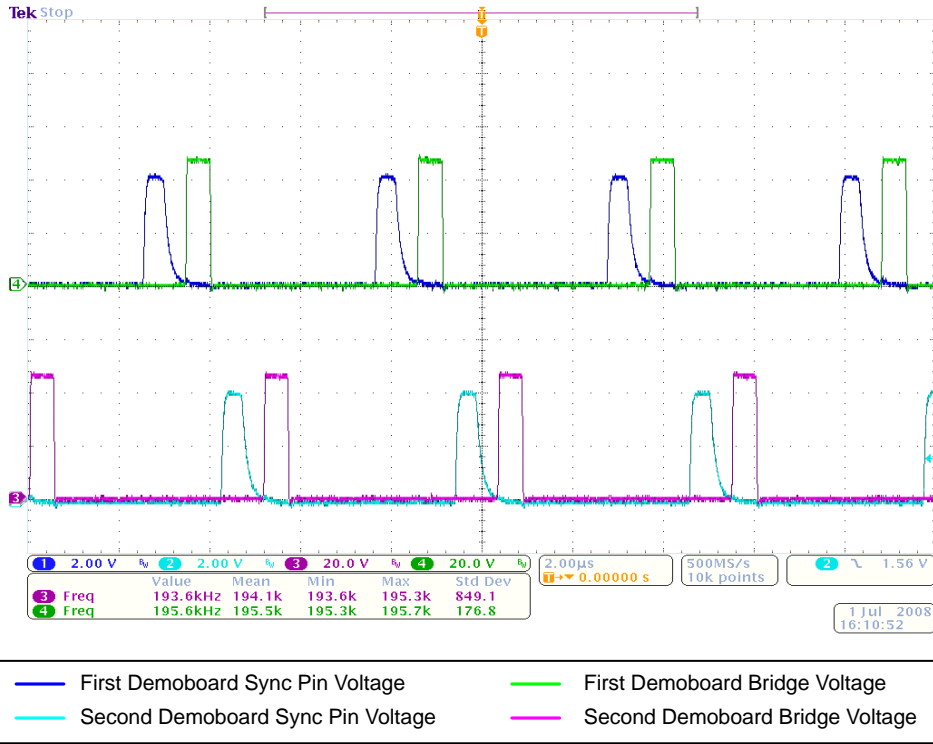

Figure 19. Output Voltage Ripple  $I_{OUT} = 0.1 \text{ A}$

**Synchronization**

Two independent boards connected (or not) via Sync pin and ground.



**Figure 20. No Synchronization**



**Figure 21. Synchronized – Sync Pins Connected**

Line and Load Regulation

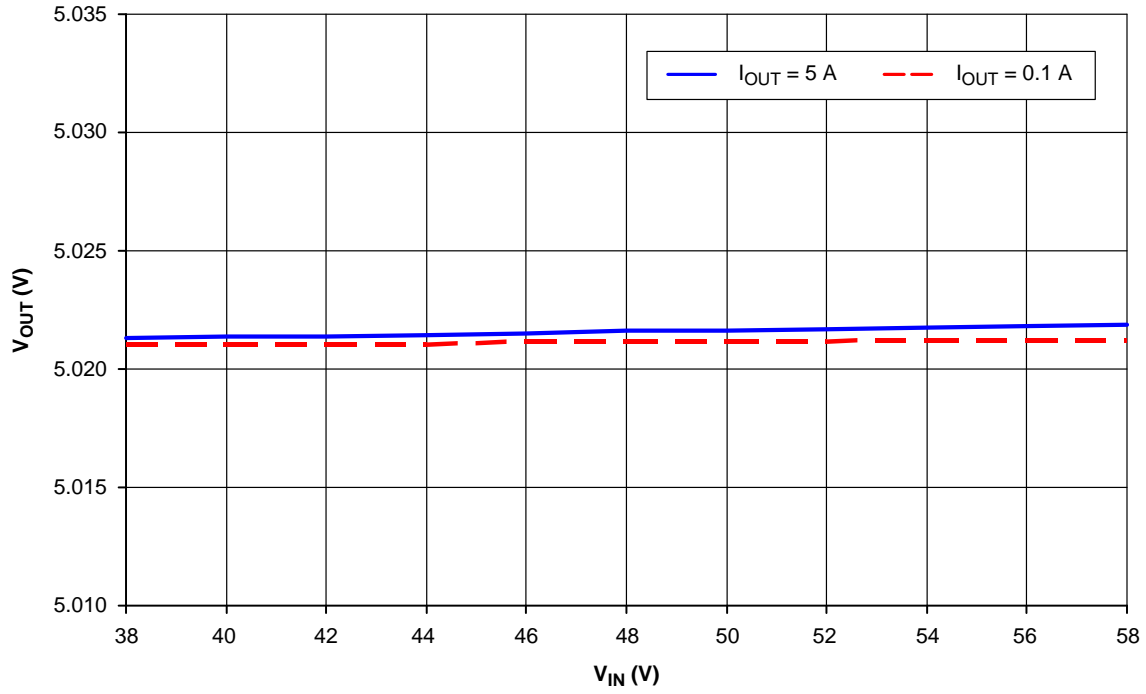

Figure 22. Line Regulation

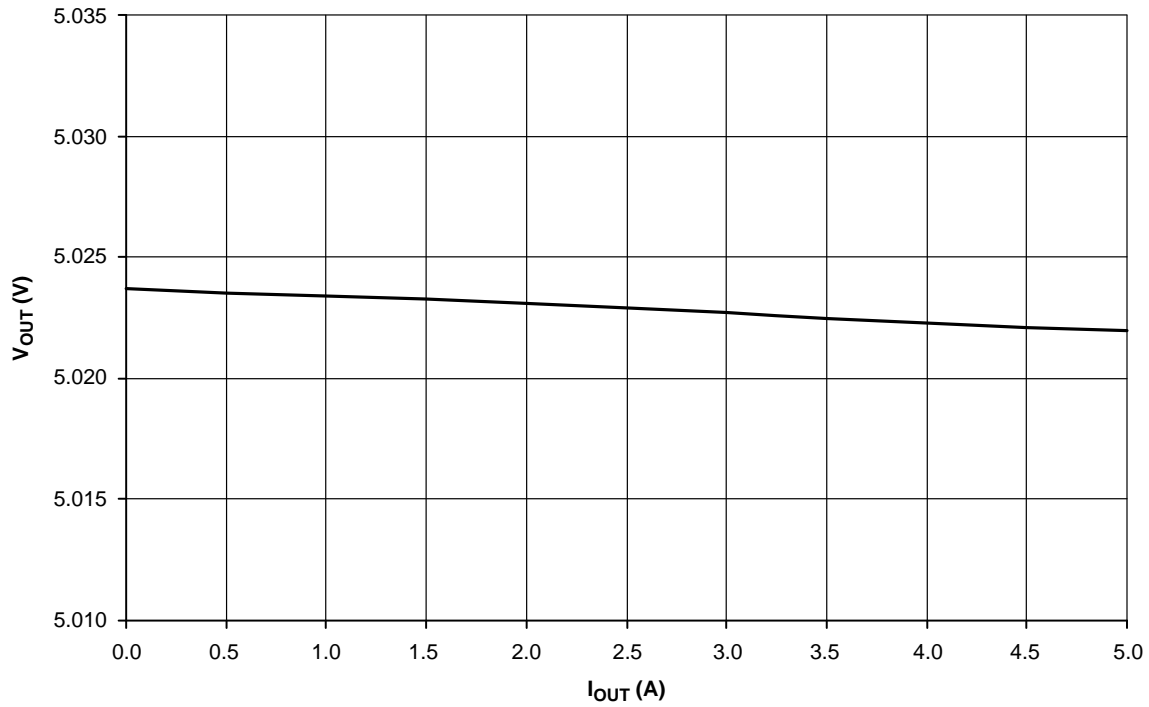
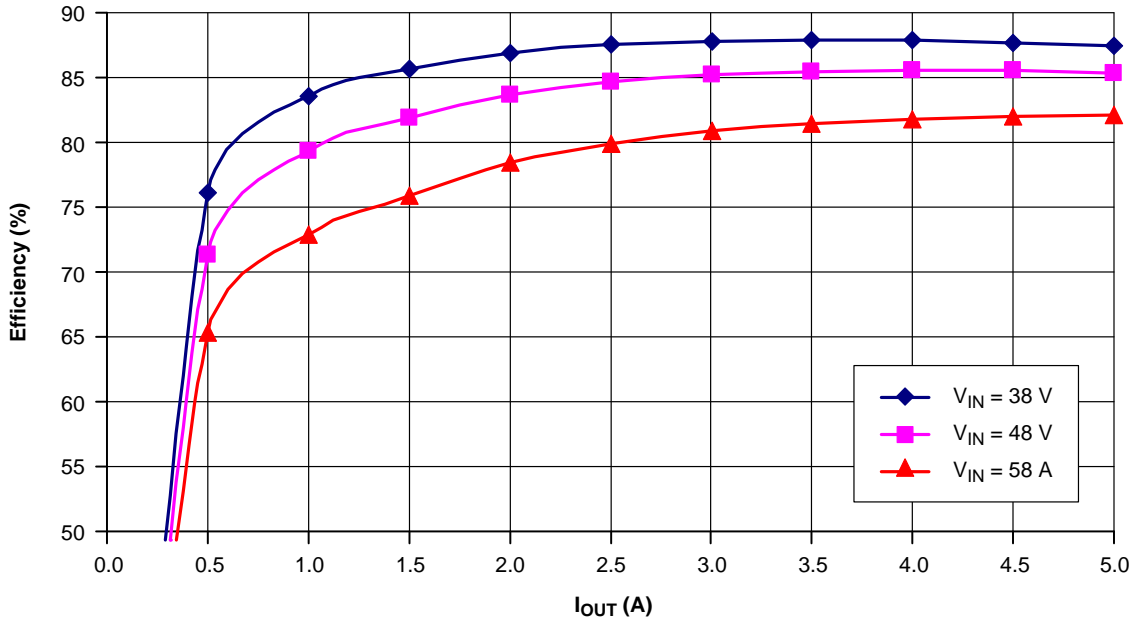

Figure 23. Load Regulation  $V_{IN} = 48\text{ V}$

# EVBUM2356/D

## Efficiency



**Figure 24. Efficiency**

		Unit	
P <sub>ind, winding</sub>	0.32	W	← Inductor Winding Loss
P <sub>core</sub>	1.20	W	← Core Loss in Inductor. Available in Inductor Data Sheet
P <sub>static, IC</sub>	0.03	W	← Static Power Loss of the IC
P <sub>high_gate</sub>	0.02	W	← Power Loss of High Power Switch Gate Charge
P <sub>low_gate</sub>	0.06	W	← Power Loss of Low Power Switch Gate Charge
P <sub>dynam, IC</sub>	0.07	W	← Dynamic Power Loss of the IC
P <sub>high_switch, cond</sub>	0.32	W	← Conduction Loss of High Power Switcher
P <sub>low_switch, cond</sub>	0.72	W	← Conduction Loss of Low Power Switcher
P <sub>high_switch, sw</sub>	0.21	W	← Switching Loss of High Power Switcher
P <sub>low_switch, sw</sub>	0.00	W	← Switching Loss of Low Power Switcher
P <sub>low_switch, body</sub>	0.92	W	← Body Diode Recovery Charge Loss
P <sub>low_dead_time</sub>	0.11	W	← Body Diode Conduction Loss
P <sub>switch_capacit</sub>	0.07	W	← Switchers Capacitance Loss
P <sub>preregulator</sub>	0.31	W	← Power Loss of Linear Preregulator V <sub>IN</sub> → V <sub>CC</sub>
P <sub>loss, total</sub>	4.37	W	← Total Loss
P <sub>out</sub>	25.00	W	← Output Power
P <sub>in</sub>	29.37	W	← Input Power = Output Power + Total Loss
Effectivity	85	%	← Efficiency of Converter (Est: ±5%)

**Figure 25. Power Loss Review from Spreadsheet**

# EVBUM2356/D

## Bode Plot

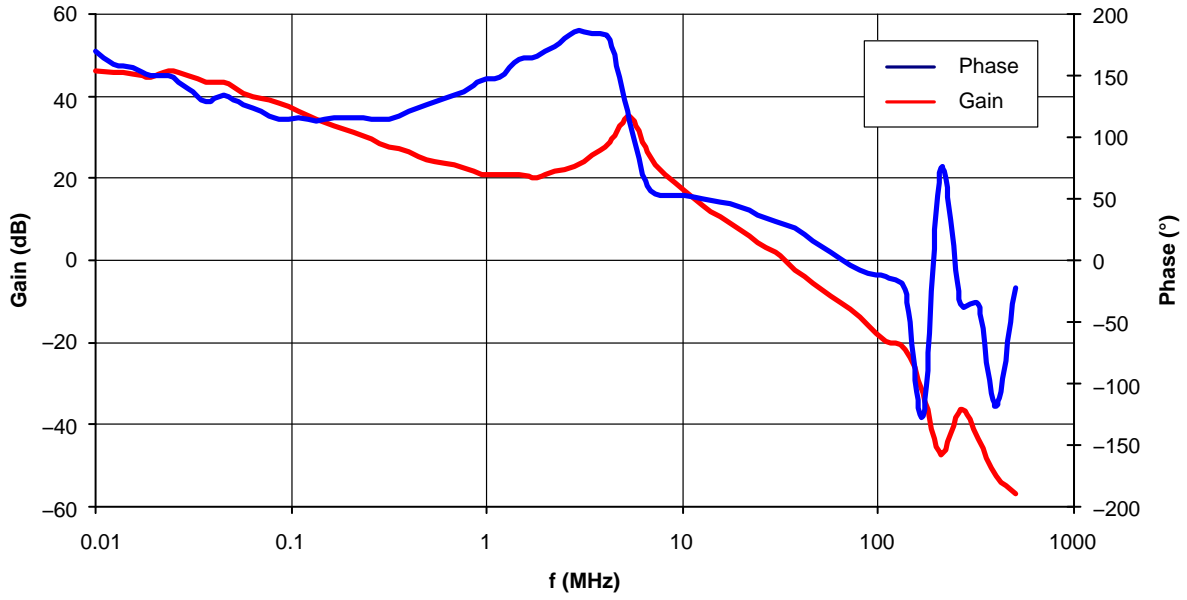



Figure 26. Bode Plot  $V_{IN} = 48\text{ V}$ ,  $I_{OUT} = 5\text{ A}$

# EVBUM2356/D

**Table 3. BILL OF MATERIALS FOR THE NCP1034 DEMOBOARD (Note 1)**

Parts	Qty	Description	Value	Tolerance	Footprint	Manufacturer	Manufacturer Part Number	Substitution Allowed
R9	1	Resistor SMD	1.2 kΩ	1%	1206	Vishay	CRCW12061K20FKEA	Yes
R5	1	Resistor SMD	3.9 kΩ	1%	1206	Vishay	CRCW12063K90FKEA	Yes
R3	1	Resistor SMD	4.7 kΩ	1%	1206	Vishay	CRCW12064K70FKEA	Yes
R2	1	Resistor SMD	5.6 kΩ	1%	1206	Vishay	CRCW12065K60FKEA	Yes
R1	1	Resistor SMD	16.9 kΩ	1%	1206	Vishay	CRCW120616K9FKEA	Yes
R6	1	Resistor SMD	20 kΩ	1%	1206	Vishay	CRCW120620K0FKEA	Yes
R11A, R11B, R11C, R11D, R11E	5	Resistor SMD	12 kΩ	1%	1206	Vishay	CRCW120612K0FKEA	Yes
R4	1	Resistor SMD	110 kΩ	1%	1206	Vishay	CRCW1206110KFKEA	Yes
R7, R8, R10	3	Resistor SMD	10 kΩ	1%	1206	Vishay	CRCW120610K0FKEA	Yes
R12A, R13, R14B, R15	4	Resistor SMD	0 Ω	1%	1206	Vishay	CRCW120600R0FKEA	Yes
R12B, R14A	2	Resistor SMD	NU	-	1206	-	-	-
C8	1	Ceramic Capacitor SMD	1.8 nF	10%	1206	Kemet	C1206C182K5RAC-TU	Yes
C6	1	Ceramic Capacitor SMD	12 nF	10%	1206	Kemet	C1206C123K5RACTU	Yes
C5	1	Ceramic Capacitor SMD	220 nF	10%	1206	Kemet	C1206C224K5RACTU	Yes
C7	1	Ceramic Capacitor SMD	330 pF	10%	1206	Yageo	CC1206KRX7R9BB331	Yes
C11, C12	2	Ceramic Capacitor SMD	NU	-	1206	-	-	Yes
C2, C3, C4, C10	4	Ceramic Capacitor SMD	100 nF	10%	1206	Kemet	C1206F104K1RACTU	Yes
C9A, C9B, C9C	3	Ceramic Capacitor SMD	47 μF/6.3 V	20%	1206	Kemet	C1210C476M9PAC7800	Yes
C1A, C1B	2	Ceramic Capacitor SMD	2.2 μF/100 V	10%	1206	Murata	GRM32ER72A225KA35L	Yes
C1C, C1D, C1E, C1F	4	Ceramic Capacitor SMD	NU	-	1206	-	-	Yes
C9D, C9E	2	Electrolytic Capacitor	NU	-	8x15	-	-	Yes
L1	1	Inductor SMD	13 μH	20%	13.2x12.8	Würth	7443551131	Yes
D1	1	Switching Diode	MMSD4148	-	SOD-123	ON Semiconductor	MMSD4148T1G	Yes
D2	1	Zener Diode 500 mW 12 V	MMSZ4699	-	SOD1-23	ON Semiconductor	MMSZ4699T1G	Yes
Q1	1	NPN Transistor	NU	-	DPAK	-	-	Yes
Q2	1	Power N-MOSFET	NTD3055	-	DPAK	ON Semiconductor	NTD3055-150G	Yes
Q3	1	Power N-MOSFET	NTD24N06	-	DPAK	ON Semiconductor	NTD24N06T4G	Yes
IO1	1	High Voltage Synchronous PWM Buck Controller	NCP1034	-	SOIC-16	ON Semiconductor	NCP1034DR2G	No
X1	1	Inlet Terminal Block	PCB 2 WAY	-	Pitch: 5 mm	Lumberg	KRM 02	Yes
X2	1	Outlet Terminal Block	PCB 2 WAY	-	Pitch: 5 mm	Lumberg	KRM 02	Yes

1. All parts are Pb-Free

ON Semiconductor and the  are registered trademarks of Semiconductor Components Industries, LLC (SCILLC) or its subsidiaries in the United States and/or other countries. SCILLC owns the rights to a number of patents, trademarks, copyrights, trade secrets, and other intellectual property. A listing of SCILLC's product/patent coverage may be accessed at [www.onsemi.com/site/pdf/Patent-Marking.pdf](http://www.onsemi.com/site/pdf/Patent-Marking.pdf). SCILLC reserves the right to make changes without further notice to any products herein. SCILLC makes no warranty, representation or guarantee regarding the suitability of its products for any particular purpose, nor does SCILLC assume any liability arising out of the application or use of any product or circuit, and specifically disclaims any and all liability, including without limitation special, consequential or incidental damages. "Typical" parameters which may be provided in SCILLC data sheets and/or specifications can and do vary in different applications and actual performance may vary over time. All operating parameters, including "Typicals" must be validated for each customer application by customer's technical experts. SCILLC does not convey any license under its patent rights nor the rights of others. SCILLC products are not designed, intended, or authorized for use as components in systems intended for surgical implant into the body, or other applications intended to support or sustain life, or for any other application in which the failure of the SCILLC product could create a situation where personal injury or death may occur. Should Buyer purchase or use SCILLC products for any such unintended or unauthorized application, Buyer shall indemnify and hold SCILLC and its officers, employees, subsidiaries, affiliates, and distributors harmless against all claims, costs, damages, and expenses, and reasonable attorney fees arising out of, directly or indirectly, any claim of personal injury or death associated with such unintended or unauthorized use, even if such claim alleges that SCILLC was negligent regarding the design or manufacture of the part. SCILLC is an Equal Opportunity/Affirmative Action Employer. This literature is subject to all applicable copyright laws and is not for resale in any manner.

## PUBLICATION ORDERING INFORMATION

### LITERATURE FULFILLMENT:

Literature Distribution Center for ON Semiconductor  
 19521 E. 32nd Pkwy, Aurora, Colorado 80011 USA  
**Phone:** 303-675-2175 or 800-344-3860 Toll Free USA/Canada  
**Fax:** 303-675-2176 or 800-344-3867 Toll Free USA/Canada  
**Email:** [orderlit@onsemi.com](mailto:orderlit@onsemi.com)

**N. American Technical Support:** 800-282-9855 Toll Free  
 USA/Canada  
**Europe, Middle East and Africa Technical Support:**  
 Phone: 421 33 790 2910  
**Japan Customer Focus Center**  
 Phone: 81-3-5817-1050

**ON Semiconductor Website:** [www.onsemi.com](http://www.onsemi.com)

**Order Literature:** <http://www.onsemi.com/orderlit>

For additional information, please contact your local Sales Representative