



■ Features :

- Universal AC input / Full range
- Withstand 300VAC surge input for 5 seconds
- Built-in active PFC function
- High efficiency up to 90%
- Low leakage current<0.4mA
- Protections: Short circuit / Overload / Over voltage / Over temperature
- Cooling by free air convection for 150W and 200W with 30CFM forced air
- Low profile:32mm
- Conformal coated
- ZVS technology to reduce power dissipation
- Built-in remote sense
- LED indicator for power on
- 3 years warranty



**SPECIFICATION**

MODEL	HSP-150-2.5	HSP-150-3.8	HSP-150-5	
OUTPUT	DC VOLTAGE	2.5V	3.8V	5V
	RATED CURRENT	30A	30A	30A
	CURRENT RANGE(convection)	0 ~ 30A	0 ~ 30A	0 ~ 30A
	PEAK CURRENT RANGE(30CFM FAN)	0 ~ 40A	0 ~ 40A	0 ~ 40A
	RATED POWER(convection)	75W	114W	150W
	PEAK POWER(30CFM FAN)	100W	152W	200W
	RIPPLE & NOISE (max.) Note.2	80mVp-p	100mVp-p	100mVp-p
	VOLTAGE ADJ. RANGE	2.35~2.75V	3.4~4.2V	4.5~5.5V
	VOLTAGE TOLERANCE Note.3	±2.0%	±2.0%	±2.0%
	LINE REGULATION	±0.5%	±0.5%	±0.5%
	LOAD REGULATION	±1.0%	±1.0%	±1.0%
	SETUP, RISE TIME	2000ms, 100ms/230VAC      3000ms, 100ms/115VAC at full load		
HOLD UP TIME (Typ.)	16ms/230VAC      16ms/115VAC at full load			
INPUT	VOLTAGE RANGE Note.4	90 ~ 264VAC      127 ~ 370VDC		
	FREQUENCY RANGE	47 ~ 63Hz		
	POWER FACTOR (Typ.)	PF ≥0.95/230VAC      PF ≥0.98/115VAC at full load		
	EFFICIENCY (Typ.)	86%	88%	90%
	AC CURRENT (Typ.)	0.8A/115VAC      0.4A/230VAC	1.2A/115VAC      0.6A/230VAC	1.5A/115VAC      0.8A/230VAC
	INRUSH CURRENT (Typ.)	Cold start 70A/230VAC		
LEAKAGE CURRENT	<0.4mA / 240VAC			
PROTECTION	OVERLOAD	140~180% rated output power Protection type : Hiccup mode, recovers automatically after fault condition is removed		
	SHORT CIRCUIT	Protection type : Hiccup mode, recovers automatically after fault condition is removed		
	OVER VOLTAGE	3.2 ~ 3.7V	4.7 ~ 5.7V	5.7 ~ 7.0V
	OVER TEMPERATURE	110°C ±5°C (TSW1) Protection type : Hiccup mode, recovers automatically after fault condition is removed		115°C ±5°C (TSW1)
ENVIRONMENT	WORKING TEMP.	-30 ~ +70°C (Refer to "Derating Curve")		
	WORKING HUMIDITY	20 ~ 90% RH non-condensing		
	STORAGE TEMP., HUMIDITY	-40 ~ +85°C, 10 ~ 95% RH		
	TEMP. COEFFICIENT	±0.03%/°C (0 ~ 60°C)		
	VIBRATION	10 ~ 500Hz, 2G 10min./1cycle, 60min. each along X, Y, Z axes		
SAFETY & EMC (Note 5)	SAFETY STANDARDS	UL60950-1,EN60950-1 approved		
	WITHSTAND VOLTAGE	I/P-O/P:3.0KVAC    I/P-FG:2KVAC    O/P-FG:0.5KVAC		
	ISOLATION RESISTANCE	I/P-O/P, I/P-FG, O/P-FG:100M Ohms/500VDC/25°C / 70%RH		
	EMC EMISSION	Compliance to EN55032 (CISPR32) Class B,EN61000-3-2,EN61000-3-3		
	EMC IMMUNITY	Compliance to EN61000-4-2,3,4,5,6,8,11;EN55024, light industry level (surge 4KV), criteria A		
OTHERS	MTBF	263.2K hrs min.    MIL-HDBK-217F (25°C)		
	DIMENSION	220*62*32mm (L*W*H)		
	PACKING	0.61kg; 24pcs/15.6kg/1.63CUFT		
NOTE	<p>1. All parameters NOT specially mentioned are measured at 230VAC input, rated load and 25°C of ambient temperature.                  2. Ripple &amp; noise are measured at 20MHz of bandwidth by using a 12" twisted pair-wire terminated with a 0.1uf &amp; 47uf parallel capacitor.                  3. Tolerance : line regulation and load regulation.                  4. Derating may be needed under low input voltages. Please check the static characteristics for more details.                  5. The power supply is considered a component which will be installed into a final equipment. All the EMC tests are been executed by mounting the unit on a 360mm*360mm metal plate with 1mm of thickness. The final equipment must be re-confirmed that it still meets EMC directives. For guidance on how to perform these EMC tests, please refer to "EMI testing of component power supplies." (as available on <a href="http://www.meanwell.com">http://www.meanwell.com</a>)</p>			

## Mechanical Specification

CASE NO.:208A

Unit:mm

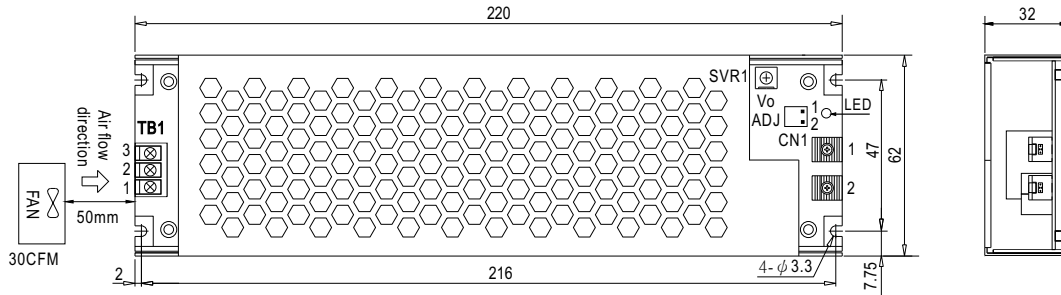

AC Input Terminal(TB1) pin NO. Assignment

Pin No.	Assignment	Terminal
1	AC/L	T21-BM10-03
2	AC/N	
3	FG $\perp$	

Remote sense pin(CN1):JS-1001-02 or equivalent

Pin No.	Assignment	Mating Housing	Terminal
1	-S	JS-2001-02 or equivalent	JS-1001-02 or equivalent
2	+S		

DC Output Terminal pin NO. Assignment

Pin No.	Assignment	Terminal
1	-V	CPB-7 M5
2	+V	

## Block Diagram

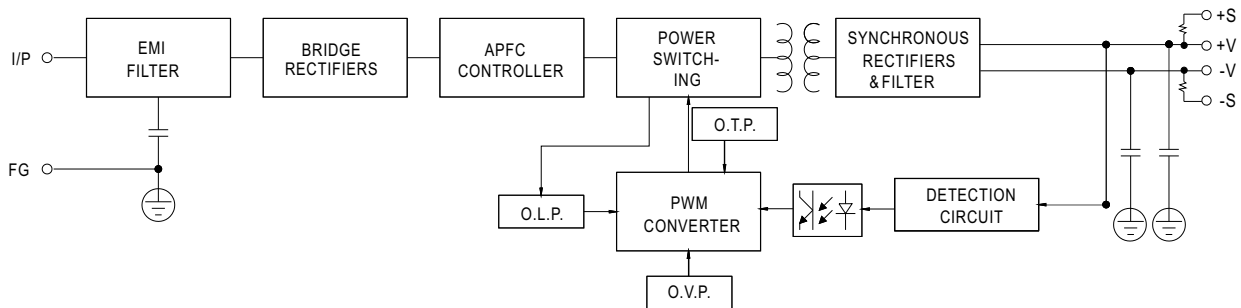

## Derating Curve

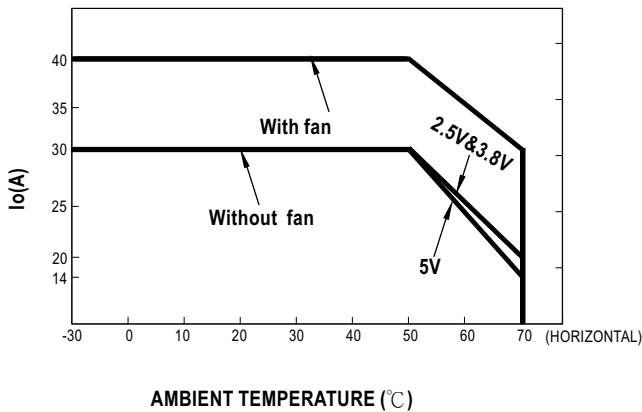

## Static Characteristics

