



MODEL: WST-1606S
PRODUCT: Electromagnetic Buzzer
EDITION: A/2016

THIS SPECIFICATION APPLIES TO THE ELECTROMAGNETIC BUZZER

SPECIFICATION

Test condition: TEMP=+25±2 °C Related humidity=65±5% Air pressure: 860 ~ 1060mbar

item	unit	specification	condition
rated voltage	Vo-p	6.0	
operating volt	Vo-p	4.0 ~ 8.0	
mean current	mA	Max.40	At rated voltage direct current
sound output	dba	85	At 10cm(A-weight free air), at rated voltage direct current
rated frequency	Hz	2300 ± 300	
operating temp	°C	-20 ~ +60	
storage temp	°C	-30 ~ +70	
dimension	mm	φ16.0 x H14.0	See attached drawing
weight	gram	4.6	
material		PPO (Black)	
terminal		Pin type (Plating Sn)	See attached drawing
environmental protection regulation		RoHS	

ENVIRONMENT TEST

item	test condition	evaluation standard
high temp. test	After being placed in a chamber at +70°C for 96 hours.	After the test the part will meet specifications without any degradation in appearance and performance except SPL, after 4 hours at +25°C. The SPL will be in ±10dba compared with initial one.
low temp. test	After being placed in a chamber at -30°C for 96 hours.	
thermal shock	The part will be subjected to 10 cycles. One cycle shall consist of:	

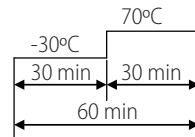

temp./humidity cycle The part will be subjected to 10 cycles.
One cycle shall be 24 hours and consist of:

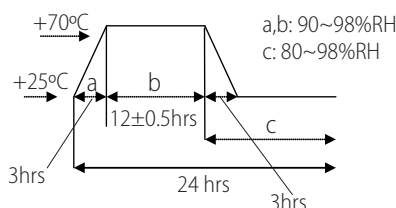



MODEL: WST-1606S
PRODUCT: Electromagnetic Buzzer
EDITION: A/2016

RELIABILITY TEST

item	test conditions	evaluation standard
operating life test	ORDINARY TEMPERATURE The part will be subjected to 96 hours of continuous operation at room temperature (+25±10°C) , 6V applied.	After the test the part will meet specifications without any degradation in appearance and performance except SPL, after 4 hours at +25°C. The SPL would be in ±10dBA compared with initial one.
	HIGH TEMPERATURE The part will be subjected to 72 hours of continuous operation at +60°C with 6V applied.	
	LOW TEMPERATURE The part will be subjected to 72 hours of continuous operation at -20°C with 6V applied.	
	HIGH AND LOW VOLTAGE Applying 4 voltage and 8 voltage, available time 24 hours each.	

TEST CONDITION

Standard Test Condition: a)Temperature: +5~+35°C b)Humidity:45~85% c)Pressure: 860~1060mbar

MECHANICAL CHARACTERISTICS

item	test conditions	evaluation standard
solderability	Lead terminal are immersed in rosin for 5 seconds and then immersed in solder bath of +250±5°C for 3±0.5 seconds.	90% min. lead terminals will be wet with solder No interference in operation.
soldering heat resistance	Lead terminal are immersed in soldering bath of +250±5°C for 2±0.5 seconds.	
terminal mechanical strength	Apply the terminal with 1KG tension for 1 minute.	No damage and cutting off.
vibration	The part will be subjected to a vibration cycle of 10Hz to 55Hz to 10Hz in a period of 1 minute. Total peak amplitude will be 1.52mm(9.3G). The vibration test will consist of 2 hours per axis in each three axes(X,Y,Z). Total 6 hours.	After the test the part will meet specifications without any damage in appearance and performance except SPL. The SPL would be in ±8dBA compared with initial one.
drop test	The part only will be dropped from a height of 75cm onto a 40mm thick wooden board 3 times in 3 axes(X,Y,Z). Total of 9 times.	

RECOMMENDED WAVE SOLDERING TEMPERATURE CURVE

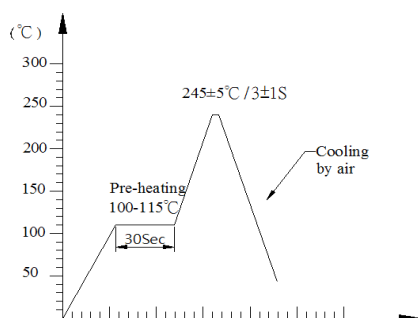



MODEL: WST-1606S
PRODUCT: Electromagnetic Buzzer
EDITION: A/2016

INSPECTION FIXTURE

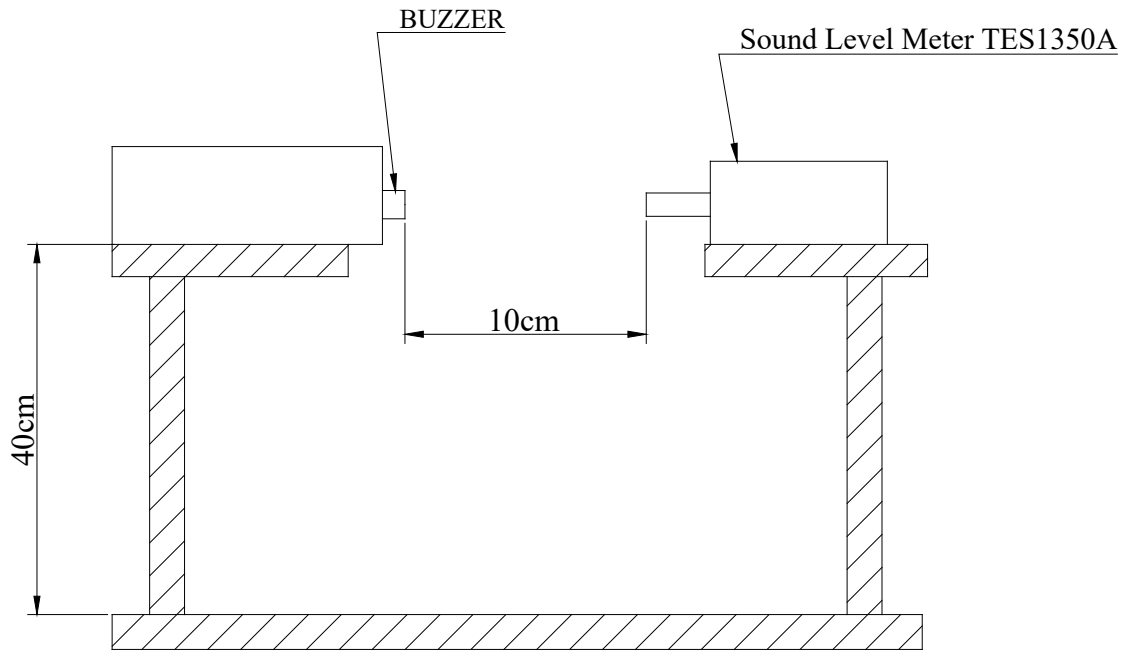

FREQUENCY RESPONSE

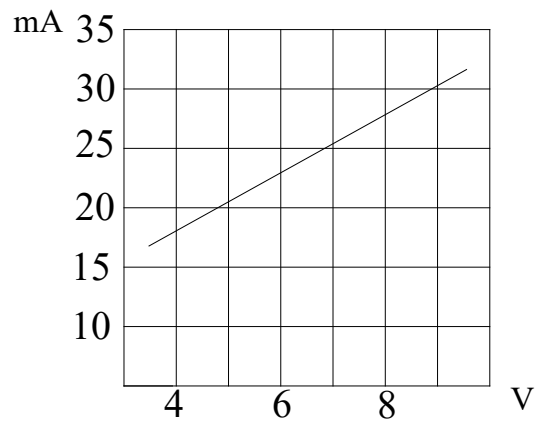
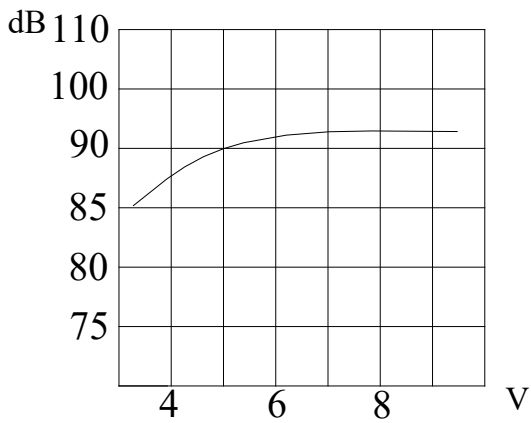



MODEL: WST-1606S
PRODUCT: Electromagnetic Buzzer
EDITION: A/2016

DIMENSIONS

Tolerance: ±0.5 (unit: mm)

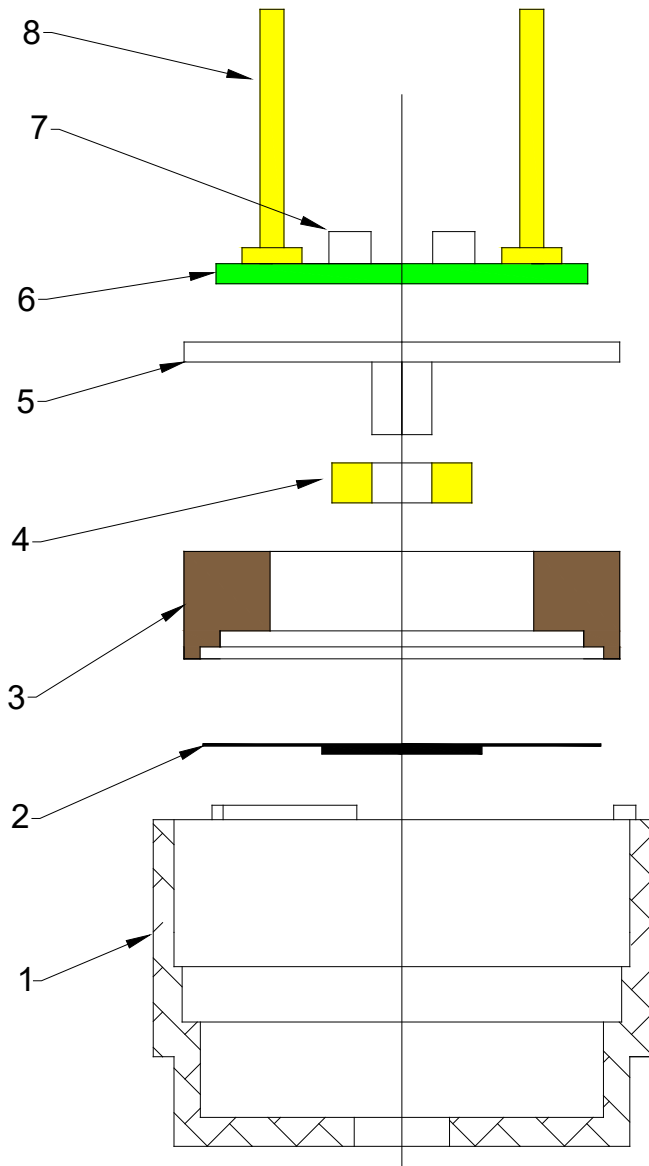
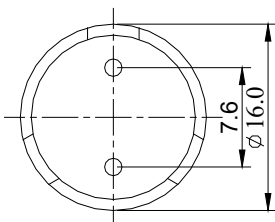
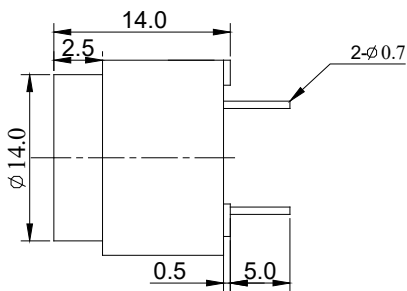
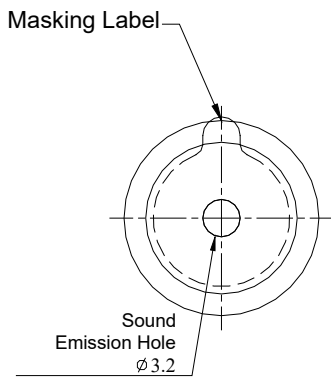
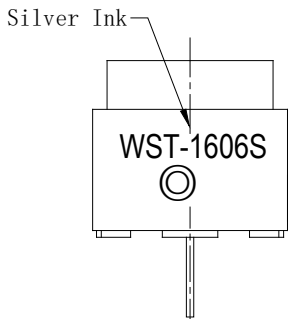

no	item	material	quantity
1	CASE	PPO	1
2	Diaphragm	Ferrum	1
3	Magnet ring	Poly+ferrite	1
4	Coil	Copper	1
5	Core	Ferrum	1
6	PCB	Epoxy glass fiber cloth + copper	1
7	Transistor	Epoxy + copper	2
8	PIN	Copper	2



MODEL: WST-1606S
PRODUCT: Electromagnetic Buzzer
EDITION: A/2016

PACKING

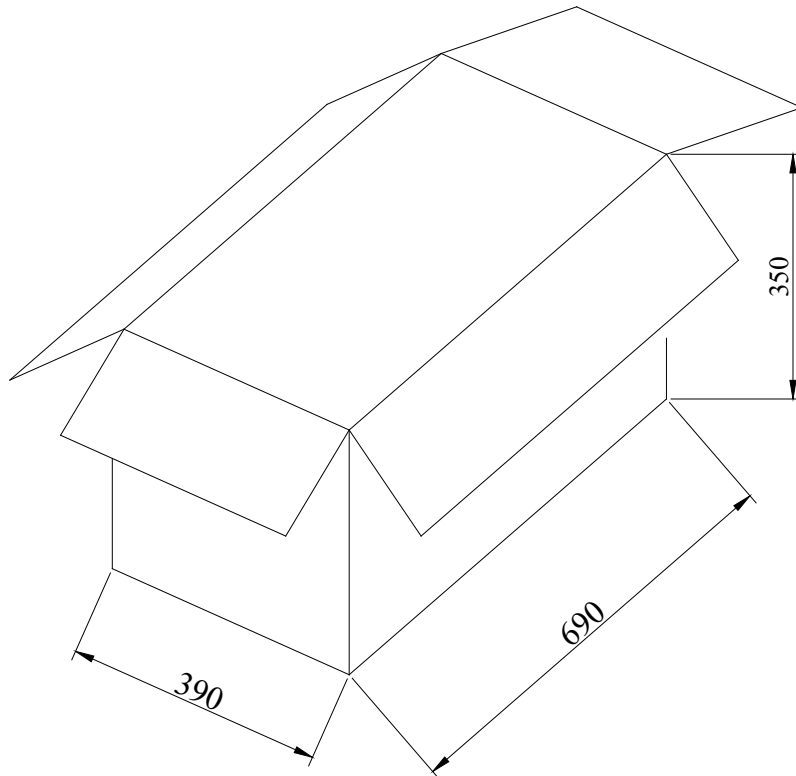
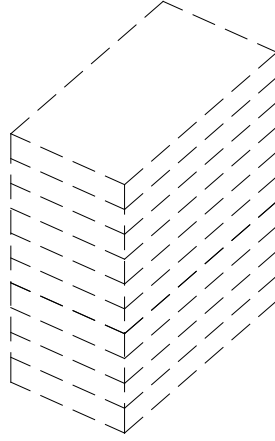

packing box	LxWxH (mm)	pieces
Tray	320 x 170 x 28	50
Inner Box	340 x 190 x 310	500
Out Box	690 x 390 x 350	2000