

Features

- 0.8 inch digit height
- Robust package
- Low power consumption
- Standard configuration: Gray face w/ white segments
- Standard Package: 200pcs/ Reel
- MSL (Moisture Sensitivity Level): 2a
- RoHS compliant



ATTENTION
OBSERVE PRECAUTIONS
FOR HANDLING
ELECTROSTATIC
DISCHARGE
SENSITIVE
DEVICES

Package Schematics

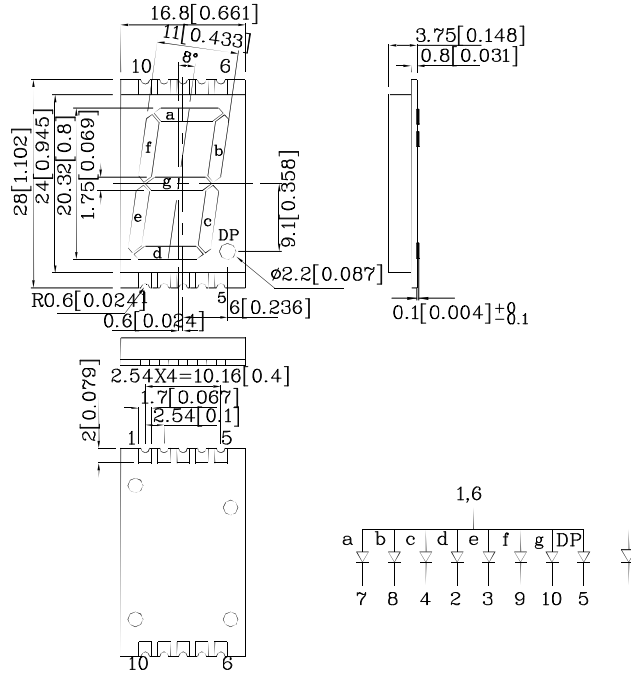

Notes:

1. All dimensions are in millimeters (inches), Tolerance is ±0.25(0.01)" unless otherwise noted.
2. Specifications are subject to change without notice.
3. The gap between the reflector and PCB shall not exceed 0.25mm.

Absolute Maximum Ratings (T _A =25°C)		Green (AlGaInP)	Unit
Reverse Voltage	V _R	5	V
Forward Current	I _F	30	mA
Forward Current (Peak) 1/10 Duty Cycle 0.1ms Pulse Width	i _{FS}	150	mA
Power Dissipation	P _D	75	mW
Operating Temperature	T _A	-40 ~ +85	°C
Storage Temperature	T _{stg}	-40 ~ +85	

A Relative Humidity between 40% and 60% is recommended in ESD-protected work areas to reduce static build up during assembly process (Reference JEDEC/JESD625-A and JEDEC/J-STD-033)

Operating Characteristics (T _A =25°C)		Green (AlGaInP)	Unit
Forward Voltage (Typ.) (I _F =10mA)	V _F	2	V
Forward Voltage (Max.) (I _F =10mA)	V _F	2.5	V
Reverse Current (Max.) (V _R =5V)	I _R	10	uA
Wavelength of Peak Emission CIE127-2007* (Typ.) (I _F =10mA)	λ _P	574*	nm
Wavelength of Dominant Emission CIE127-2007* (Typ.) (I _F =10mA)	λ _D	570*	nm
Spectral Line Full Width At Half-Maximum (Typ.) (I _F =10mA)	Δλ	20	nm
Capacitance (Typ.) (V _F =0V, f=1MHz)	C	15	pF

Part Number	Emitting Color	Emitting Material	Luminous Intensity CIE127-2007* (I _F =10mA) ucd		Wavelength CIE127-2007* nm λ _P	Description
			min.	typ.		
XZFVG20A-A	Green	AlGaInP	9000	17990	574*	Common Anode, Rt. Hand Decimal.
			2200*	5990*		

*Luminous intensity value and wavelength are in accordance with CIE127-2007 standards.

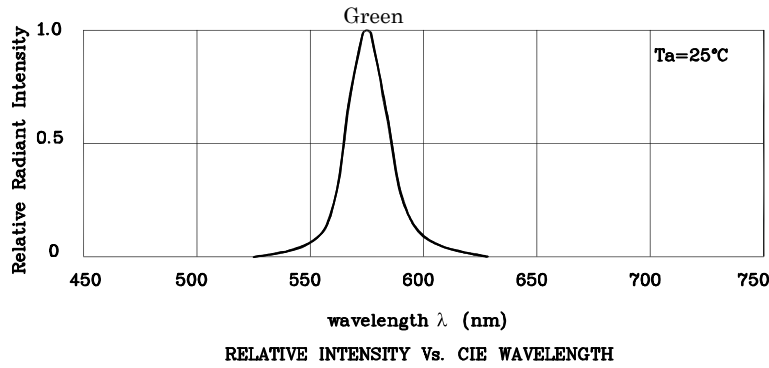

❖ Green

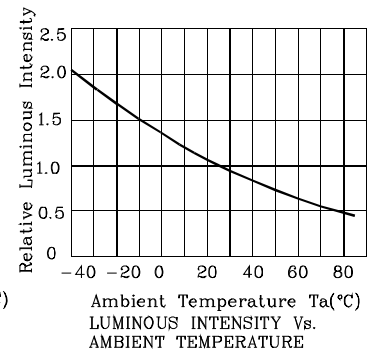
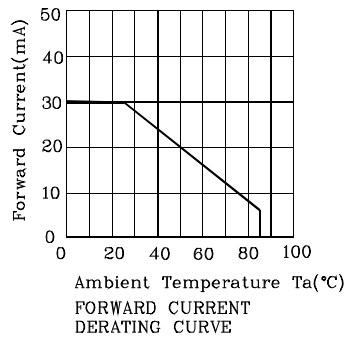
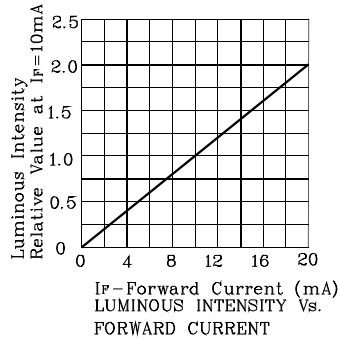
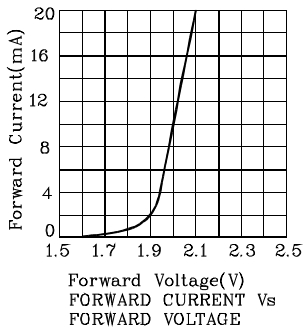

LED is recommended for reflow soldering and soldering profile is shown below.

Reflow Soldering Profile for SMD Products (Pb-Free Components)

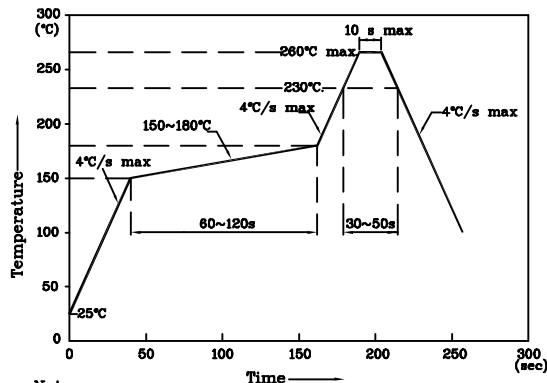

- Notes:
1. Maximum soldering temperature should not exceed 260°C
 2. Recommended reflow temperature: 145°C-260°C
 3. Do not put stress to the epoxy resin during high temperatures conditions

PACKING & LABEL SPECIFICATIONS

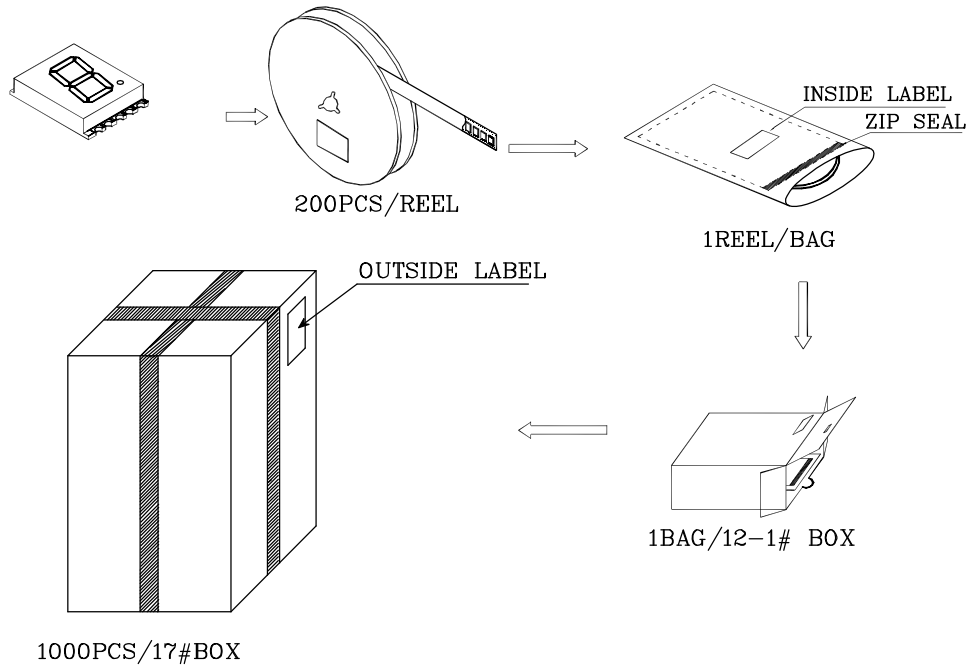

Inside Label On TAPE

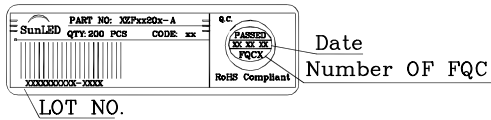

Outside Label On BAG

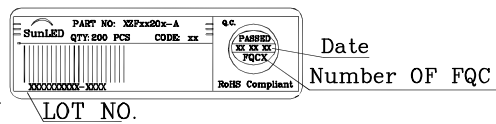

Outside Label On 19#Box

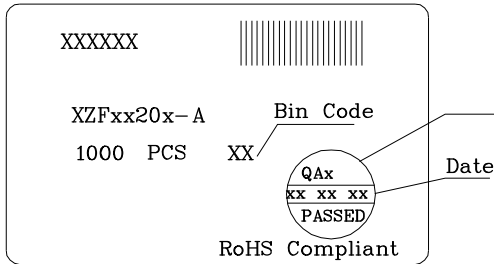

Outside Label On 12#Box

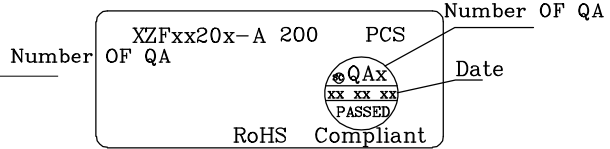

TERMS OF USE

1. Data presented in this document reflect statistical figures and should be treated as technical reference only.
2. Contents within this document are subject to improvement and enhancement changes without notice.
3. The product(s) in this document are designed to be operated within the electrical and environmental specifications indicated on the datasheet. User accepts full risk and responsibility when operating the product(s) beyond their intended specifications.
4. The product(s) described in this document are intended for electronic applications in which a person's life is not reliant upon the LED. Please consult with a SunLED representative for special applications where the LED may have a direct impact on a person's life.
5. The contents within this document may not be altered without prior consent by SunLED.
6. Additional technical notes are available at <http://www.SunLEDusa.com/TechnicalNotes.asp>