

PLEASE CHECK WWW.MOLEX.COM FOR LATEST PART INFORMATION

Part Number: [62200-9000](#)
Status: **Active**
Description: Micro-D Backshell Crimp Tool Kit, 9 Circuits

Documents:
[RoHS Certificate of Compliance \(PDF\)](#)

General

Product Family	Application Tooling
Series	T3002
Comments	This tool kit is intended for use in the Basic Arbor Press. See Tooling Specification (PDF) Above
Function	Crimp
Geographic Area	Global
Level of Automation	Manual
More Detailed Tech Information	applicationtooling@molex.com
Product Name	N/A
Survey	www.molex.com//review/apptool_survey.html
Tool Type	Tool Kit
UPC	800754012676

Material Info

Reference - Drawing Numbers

Application Tooling Documents	ATS-622008900, ATS-622009000
Sales Drawing	622009000

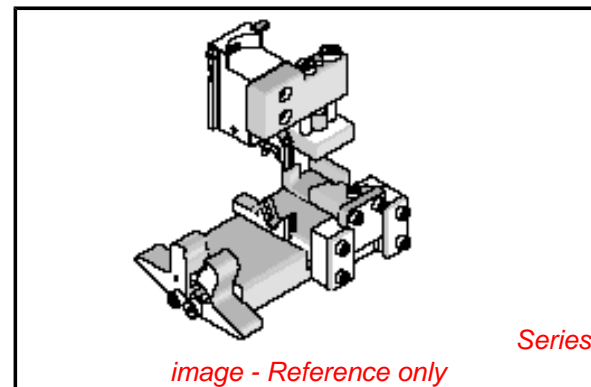

image - Reference only

EU RoHS	China RoHS
----------------	-------------------

Compliance Status

Not Reviewed

REACH SVHC

Not Reviewed

Low-Halogen Status

Not Reviewed

Need more information on product environmental compliance?

Email productcompliance@molex.com
 For a multiple part number RoHS Certificate of Compliance, [click here](#)

Please visit the [Contact Us](#) section for any non-product compliance questions.

Search Parts in this Series

[T3002Series](#)

Use With

[62201-9800](#)

Application Tooling Description	FAQ Product #
1.27mm Pitch Commercial Micro D, Cable Receptacle Kit, 9 Circuits	0834219014

PLEASE CHECK WWW.MOLEX.COM FOR LATEST PART INFORMATION