

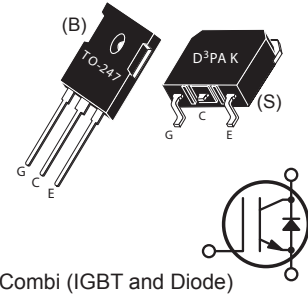

High Speed PT IGBT

POWER MOS 8® is a high speed Punch-Through switch-mode IGBT. Low E_{off} is achieved through leading technology silicon design and lifetime control processes. A reduced $E_{off} - V_{CE(ON)}$ tradeoff results in superior efficiency compared to other IGBT technologies. Low gate charge and a greatly reduced ratio of C_{res}/C_{ies} provide excellent noise immunity, short delay times and simple gate drive. The intrinsic chip gate resistance and capacitance of the poly-silicone gate structure help control di/dt during switching, resulting in low EMI, even when switching at high frequency.



FEATURES

- Fast switching with low EMI
- Very Low E_{off} for maximum efficiency
- Ultra low C_{res} for improved noise immunity
- Low conduction loss
- Low gate charge
- Increased intrinsic gate resistance for low EMI
- RoHS compliant 

TYPICAL APPLICATIONS

- ZVS phase shifted and other full bridge
- Half bridge
- High power PFC boost
- Welding
- UPS, solar, and other inverters
- High frequency, high efficiency industrial

Absolute Maximum Ratings

Symbol	Parameter	Ratings	Unit
V_{CES}	Collector Emitter Voltage	900	V
I_{C1}	Continuous Collector Current @ $T_c = 25^\circ\text{C}$	78	A
I_{C2}	Continuous Collector Current @ $T_c = 100^\circ\text{C}$	43	
I_{CM}	Pulsed Collector Current ¹	129	
V_{GE}	Gate-Emitter Voltage ²	± 30	V
P_D	Total Power Dissipation @ $T_c = 25^\circ\text{C}$	337	W
SSOA	Switching Safe Operating Area @ $T_j = 150^\circ\text{C}$	129A @ 900V	
T_j, T_{STG}	Operating and Storage Junction Temperature Range	-55 to 150	°C
T_L	Lead Temperature for Soldering: 0.063" from Case for 10 Seconds	300	

Static Characteristics

$T_j = 25^\circ\text{C}$ unless otherwise specified

Symbol	Parameter	Test Conditions	Min	Typ	Max	Unit
$V_{BR(CES)}$	Collector-Emitter Breakdown Voltage	$V_{GE} = 0\text{V}, I_C = 1.0\text{mA}$	900			V
$V_{CE(on)}$	Collector-Emitter On Voltage	$V_{GE} = 15\text{V}, I_C = 25\text{A}$		2.5 2.2	3.1	
		$T_j = 25^\circ\text{C}$ $T_j = 125^\circ\text{C}$				
$V_{GE(th)}$	Gate Emitter Threshold Voltage	$V_{GE} = V_{CE}, I_C = 1\text{mA}$	3	4.5	6	μA
I_{CES}	Zero Gate Voltage Collector Current	$V_{CE} = 900\text{V}, V_{GE} = 0\text{V}$			350 1500	
		$T_j = 25^\circ\text{C}$ $T_j = 125^\circ\text{C}$				
I_{GES}	Gate-Emitter Leakage Current	$V_{GS} = \pm 30\text{V}$			± 100	nA

Thermal and Mechanical Characteristics

Symbol	Characteristic	Min	Typ	Max	Unit
$R_{\theta JC}$	Junction to Case Thermal Resistance (IGBT)	-	-	0.37	°C/W
$R_{\theta JC}$	Junction to Case Thermal Resistance (Diode)	-	-	0.80	
W_T	Package Weight	-	5.9	-	g
Torque	Mounting Torque (TO-247 Package), 4-40 or M3 screw			10	in-lbf

Dynamic Characteristics

T_J = 25°C unless otherwise specified

APT43GA90BD_SD30

Symbol	Parameter	Test Conditions	Min	Typ	Max	Unit
C _{ies}	Input Capacitance	Capacitance V _{GE} = 0V, V _{CE} = 25V f = 1MHz		2465		pF
C _{oes}	Output Capacitance			227		
C _{res}	Reverse Transfer Capacitance			34		
Q _g ²	Total Gate Charge	Gate Charge V _{GE} = 15V V _{CE} = 450V I _C = 25A		116		nC
Q _{ge}	Gate-Emitter Charge			18		
Q _{gc}	Gate- Collector Charge			44		
SSOA	Switching Safe Operating Area	T _J = 150°C, R _G = 4.7Ω, V _{GE} = 15V, L = 100uH, V _{CE} = 900V	129			A
t _{d(on)}	Turn-On Delay Time	Inductive Switching (25°C) V _{CC} = 600V V _{GE} = 15V I _C = 25A R _G = 4.7Ω ³ T _J = +25°C		12		ns
t _r	Current Rise Time			16		
t _{d(off)}	Turn-Off Delay Time			82		
t _f	Current Fall Time			57		
E _{on2}	Turn-On Switching Energy			875		
E _{off} ⁵	Turn-Off Switching Energy		425			
t _{d(on)}	Turn-On Delay Time	Inductive Switching (125°C) V _{CC} = 600V V _{GE} = 15V I _C = 25A R _G = 4.7Ω ³ T _J = +125°C		12		ns
t _r	Current Rise Time			16		
t _{d(off)}	Turn-Off Delay Time			117		
t _f	Current Fall Time			129		
E _{on2}	Turn-On Switching Energy			1646		
E _{off} ⁵	Turn-Off Switching Energy		800			

1 Repetitive Rating: Pulse width and case temperature limited by maximum junction temperature.

2 Pulse test: Pulse Width < 380μs, duty cycle < 2%. See Mil-Std-750 Method 3471

3 R_G is external gate resistance, not including internal gate resistance or gate driver impedance. (MIC4452)

4 E_{on1} is the inductive turn-on energy of the IGBT only, without the effect of a commutating diode reverse recovery current adding to the IGBT turn-on switching loss. It is measured by clamping the inductance with a silicon carbide Schottky diode.

5 E_{off} is the clamped inductive turn-off energy measured in accordance with JEDEC standard JESD24-1.

Microsemi reserves the right to change, without notice, the specifications and information contained herein.

Typical Performance Curves

APT43GA90BD_SD30

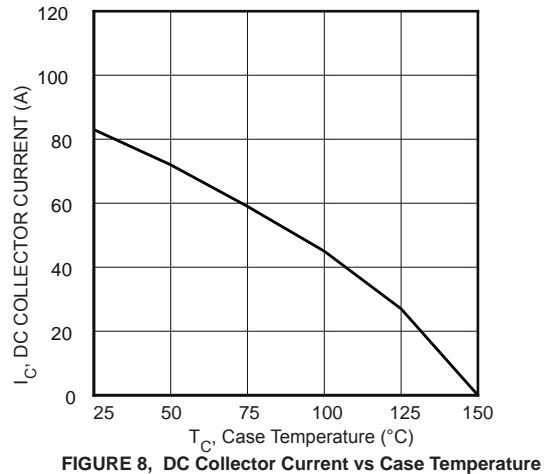
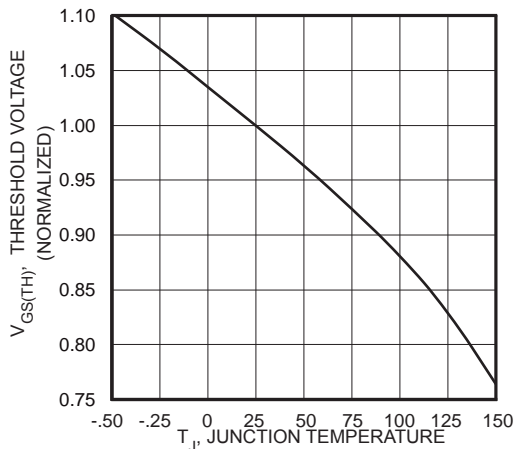
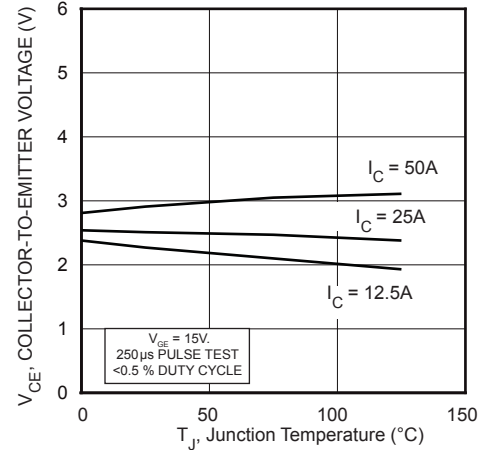
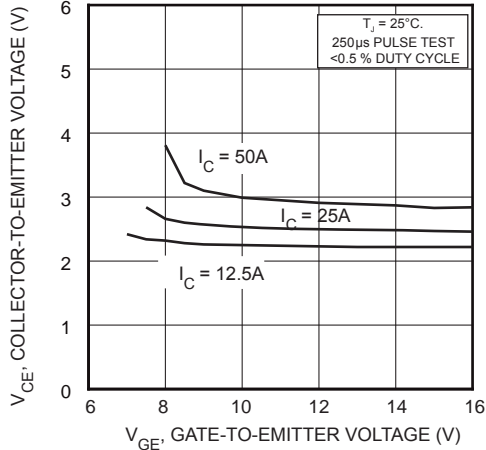
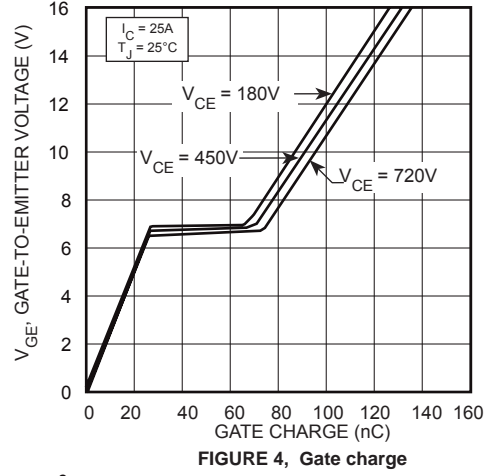
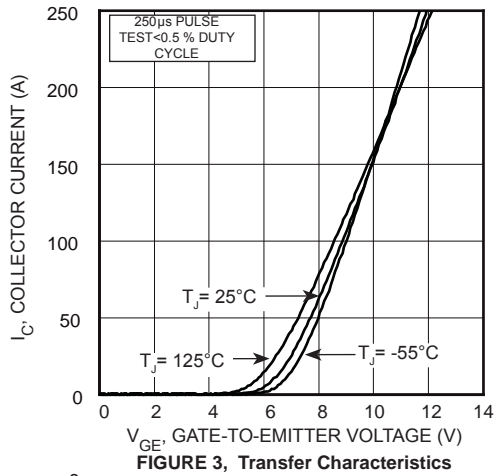
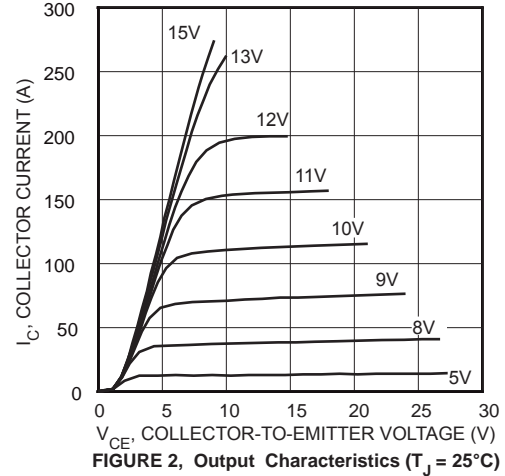
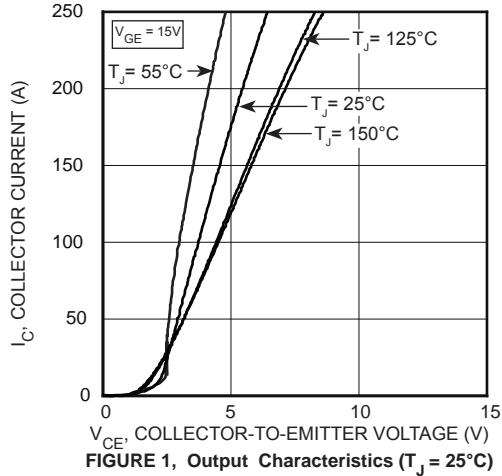

Typical Performance Curves

APT43GA90BD_SD30

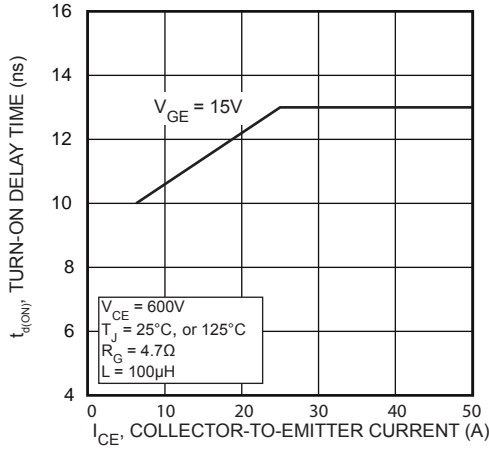

FIGURE 9, Turn-On Delay Time vs Collector Current

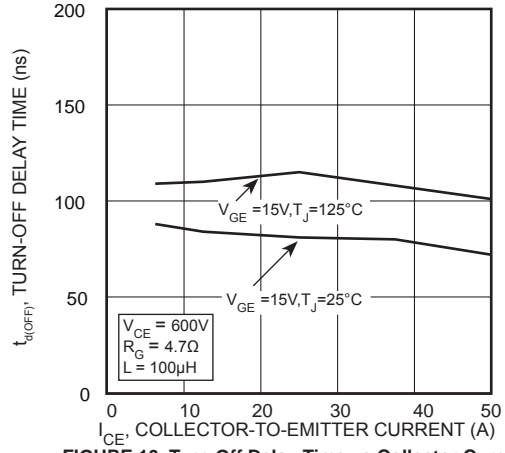

FIGURE 10, Turn-Off Delay Time vs Collector Current

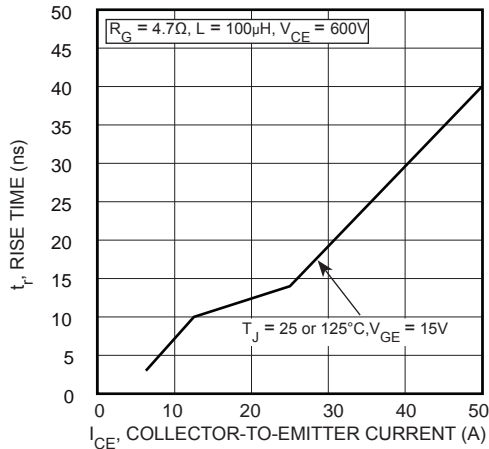

FIGURE 11, Current Rise Time vs Collector Current

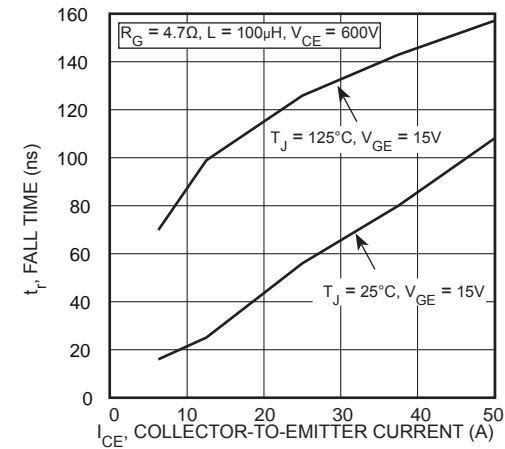

FIGURE 12, Current Fall Time vs Collector Current

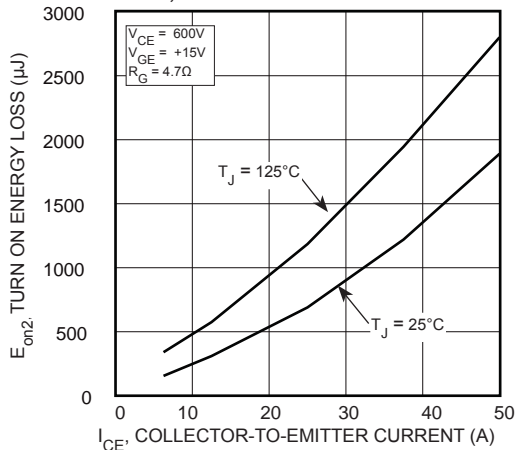

FIGURE 13, Turn-On Energy Loss vs Collector Current

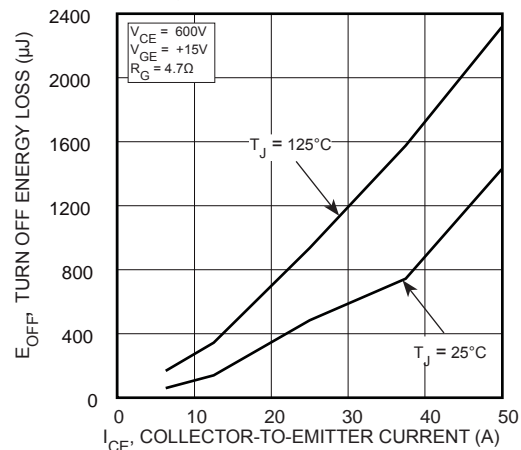

FIGURE 14, Turn-Off Energy Loss vs Collector Current

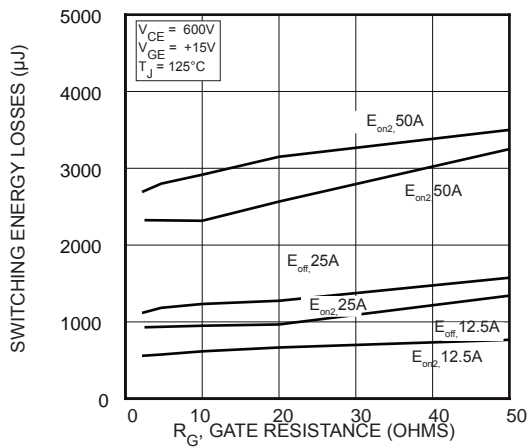

FIGURE 15, Switching Energy Losses vs Gate Resistance

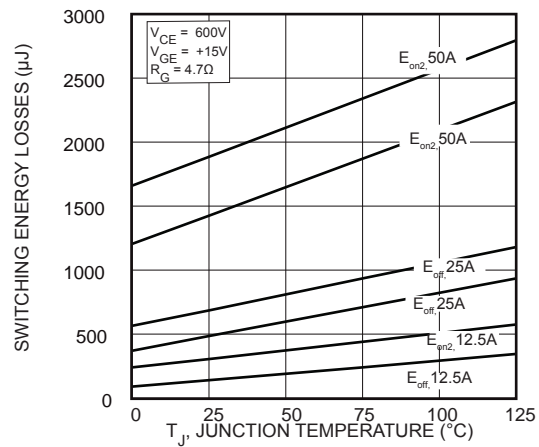

FIGURE 16, Switching Energy Losses vs Junction Temperature

Typical Performance Curves

APT43GA90BD_SD30

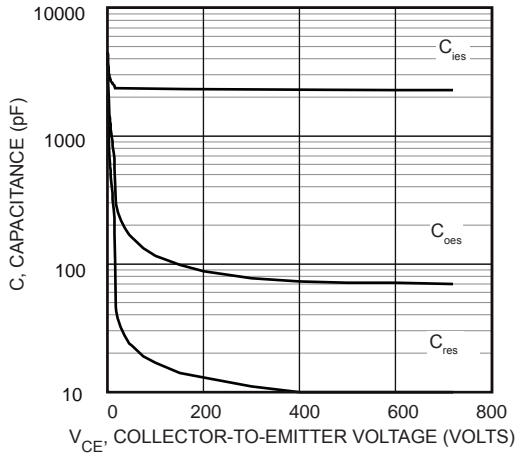

FIGURE 17, Capacitance vs Collector-To-Emitter Voltage

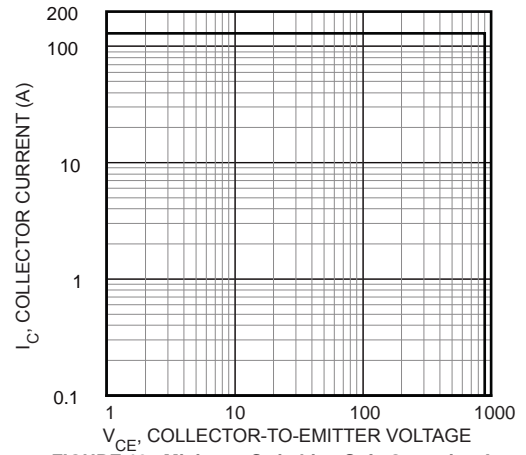

FIGURE 18, Minimum Switching Safe Operating Area

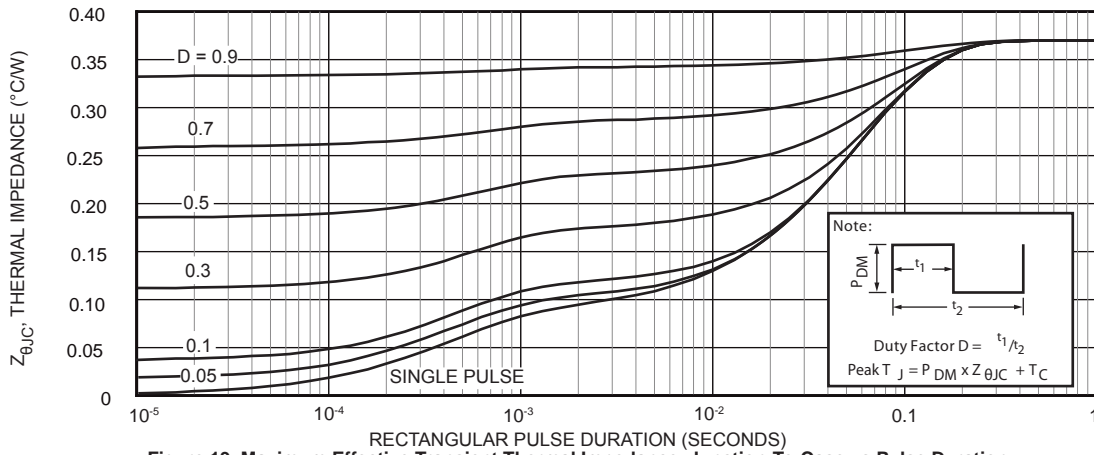

Figure 19, Maximum Effective Transient Thermal Impedance, Junction-To-Case vs Pulse Duration

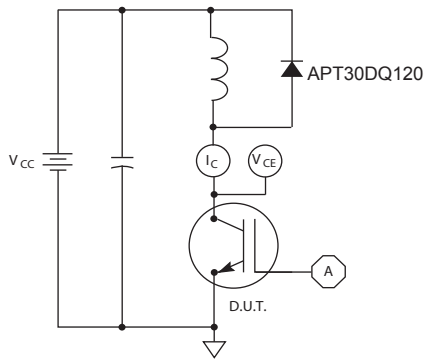

Figure 20, Inductive Switching Test Circuit

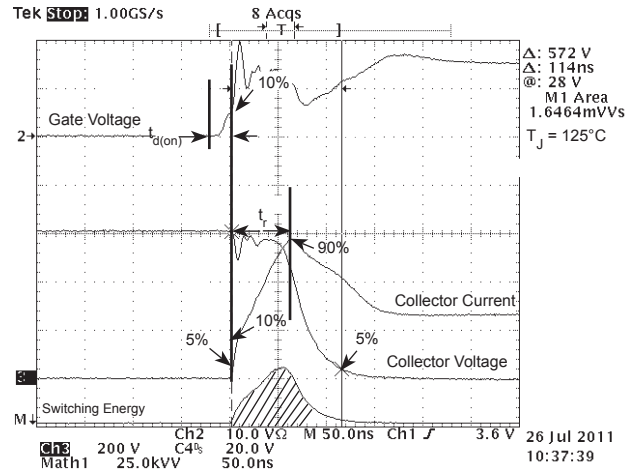

Figure 21, Turn-on Switching Waveforms and Definitions

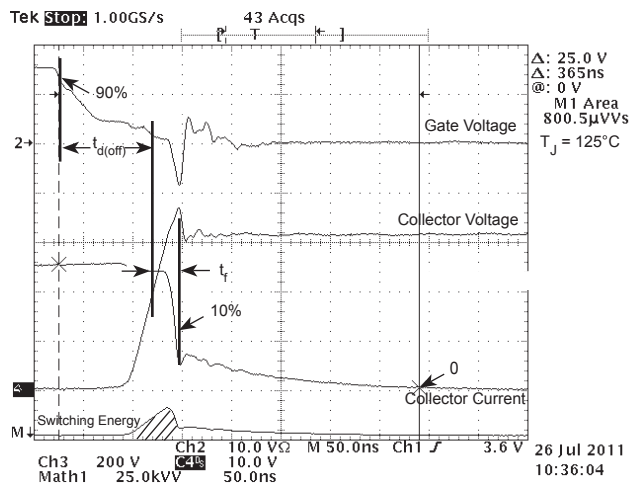

Figure 22, Turn-off Switching Waveforms and Definitions

ULTRAFAST SOFT RECOVERY RECTIFIER DIODE

MAXIMUM RATINGS

All Ratings: $T_C = 25^\circ\text{C}$ unless otherwise specified.

Symbol	Characteristic / Test Conditions	APT43GA90BD_SD30	Unit
$I_{F(AV)}$	Maximum Average Forward Current ($T_C = 117^\circ\text{C}$, Duty Cycle = 0.5)	30	Amps
$I_{F(RMS)}$	RMS Forward Current (Square wave, 50% duty)	46	
I_{FSM}	Non-Repetitive Forward Surge Current ($T_J = 45^\circ\text{C}$, 8.3 ms)	320	

STATIC ELECTRICAL CHARACTERISTICS

Symbol	Characteristic / Test Conditions	Min	Type	Max	Unit
V_F	Forward Voltage	$I_F = 30\text{A}$		2.5	Volts
		$I_F = 60\text{A}$		3.1	
		$I_F = 30\text{A}, T_J = 125^\circ\text{C}$		1.9	

DYNAMIC CHARACTERISTICS

Symbol	Characteristic	Test Conditions	Min	Typ	Max	Unit	
t_{rr}	Reverse Recovery Time	$I_F = 1\text{A}, di_F/dt = -100\text{A}/\mu\text{s}, V_R = 30\text{V}, T_J = 25^\circ\text{C}$	-	24	-	ns	
t_{rr}	Reverse Recovery Time	$I_F = 30\text{A}, di_F/dt = -200\text{A}/\mu\text{s}, V_R = 667\text{V}, T_C = 25^\circ\text{C}$	-	295	-	ns	
Q_{rr}	Reverse Recovery Charge		-	440	-		nC
I_{RRM}	Maximum Reverse Recovery Current		-	4	-		Amps
t_{rr}	Reverse Recovery Time	$I_F = 30\text{A}, di_F/dt = -200\text{A}/\mu\text{s}, V_R = 667\text{V}, T_C = 125^\circ\text{C}$	-	330	-	ns	
Q_{rr}	Reverse Recovery Charge		-	1550	-	nC	
I_{RRM}	Maximum Reverse Recovery Current		-	8	-	Amps	
t_{rr}	Reverse Recovery Time	$I_F = 30\text{A}, di_F/dt = -1000\text{A}/\mu\text{s}, V_R = 667\text{V}, T_C = 125^\circ\text{C}$	-	150	-	ns	
Q_{rr}	Reverse Recovery Charge		-	2250	-	nC	
I_{RRM}	Maximum Reverse Recovery Current		-	25	-	Amps	

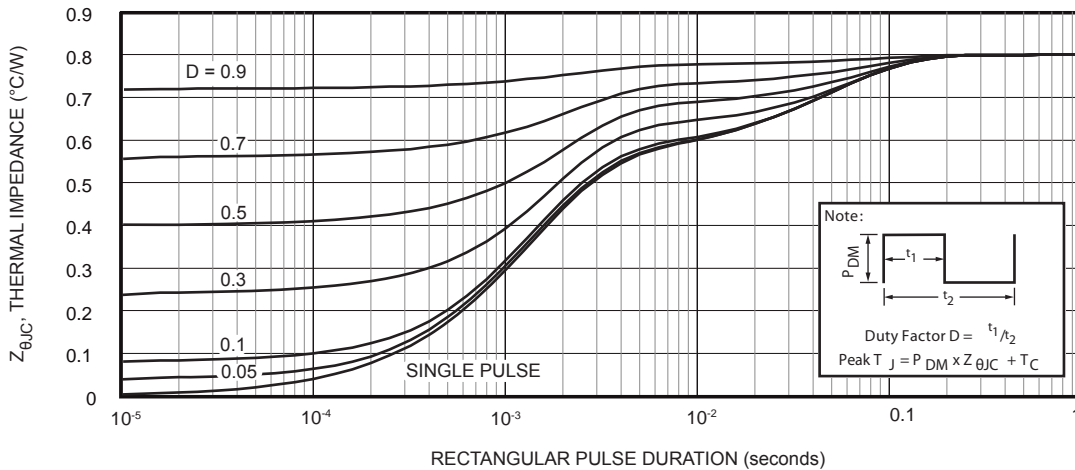

FIGURE 23. MAXIMUM EFFECTIVE TRANSIENT THERMAL IMPEDANCE, JUNCTION-TO-CASE vs. PULSE DURATION

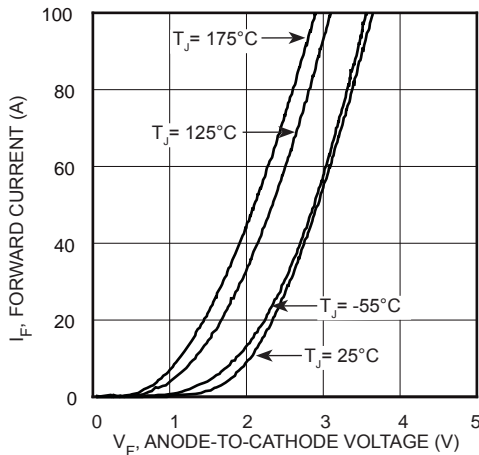

FIGURE 24, Forward Current vs. Forward Voltage

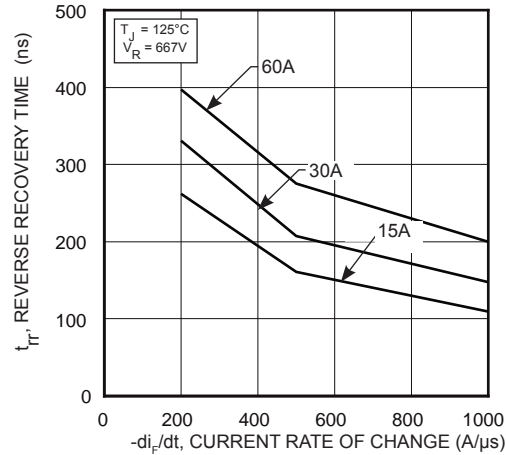

FIGURE 25, Reverse Recovery Time vs. Current Rate of Change

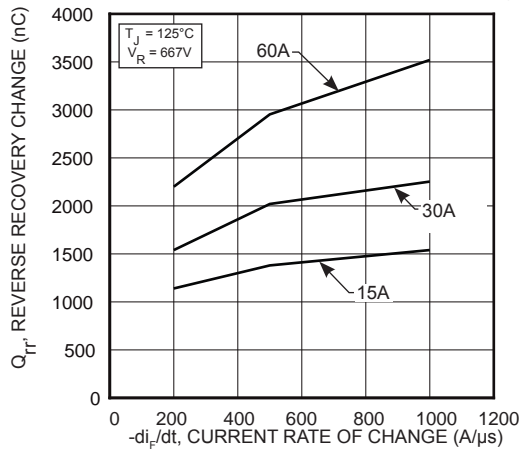

FIGURE 26, Reverse Recovery Change vs. Current Rate of Change

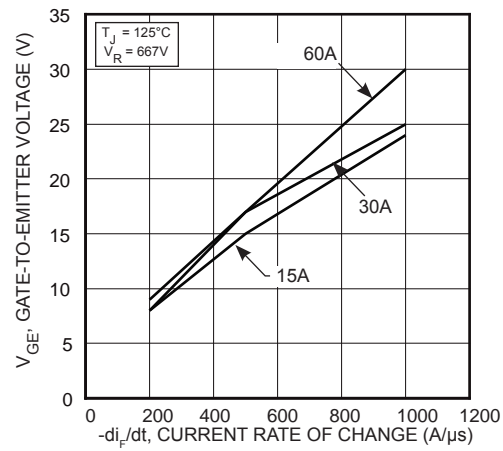

FIGURE 27, Reverse Recovery Current vs. Current Rate of Change

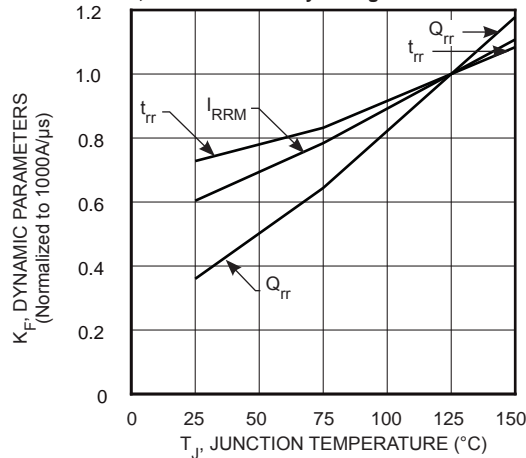

FIGURE 28, Dynamic Parameters vs. Junction Temperature

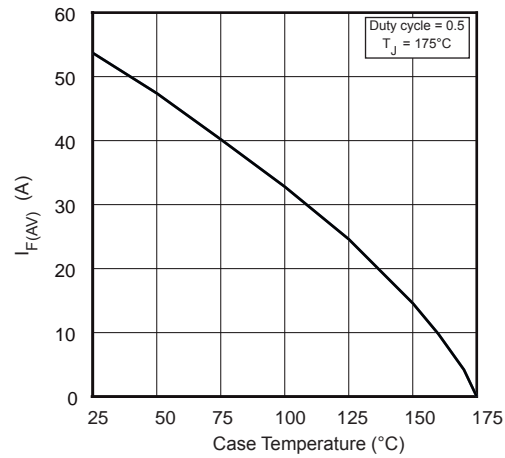

FIGURE 29, Maximum Average Forward Current vs. Case Temperature

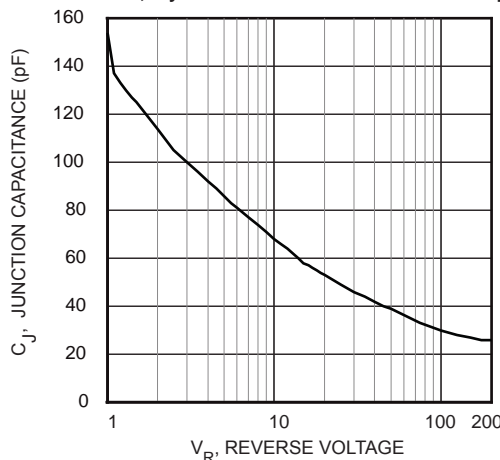

FIGURE 30, Junction Capacitance vs. Reverse Voltage

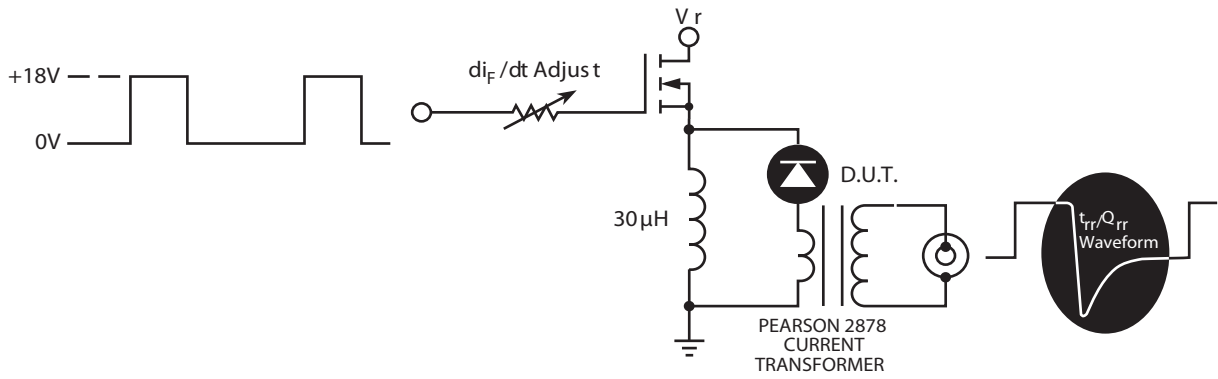

Figure 31. Diode Test Circuit

- 1 I_F - Forward Conduction Current
- 2 di_F/dt - Rate of Diode Current Change Through Zero Crossing.
- 3 I_{RRM} - Maximum Reverse Recovery Current
- 4 t_{rr} - Reverse Recovery Time measured from zero crossing where diode current goes from positive to negative, to the point at which the straight line through I_{RRM} and 0.25 I_{RRM} passes through zero.
- 5 Q_{rr} - Area Under the Curve Defined by I_{RRM} and t_{rr}.

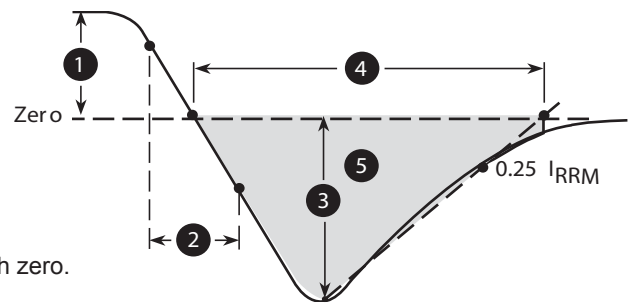
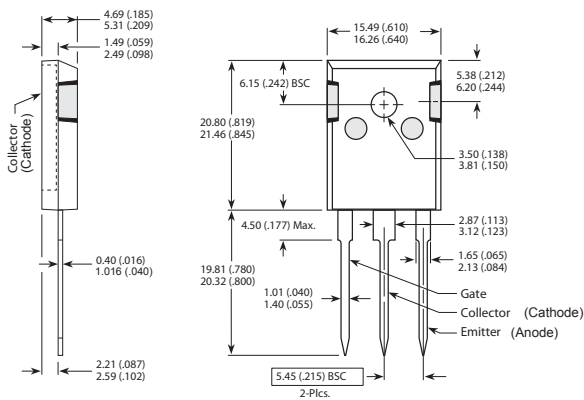

Figure 32. Diode Reverse Recovery Waveform Definition

TO-247 Package Outline

Ⓔ1 SAC: Tin, Silver, Copper



Dimensions in Millimeters (Inches)

D³PAK Package Outline

Ⓔ3 SAC: Tin, Silver, Copper

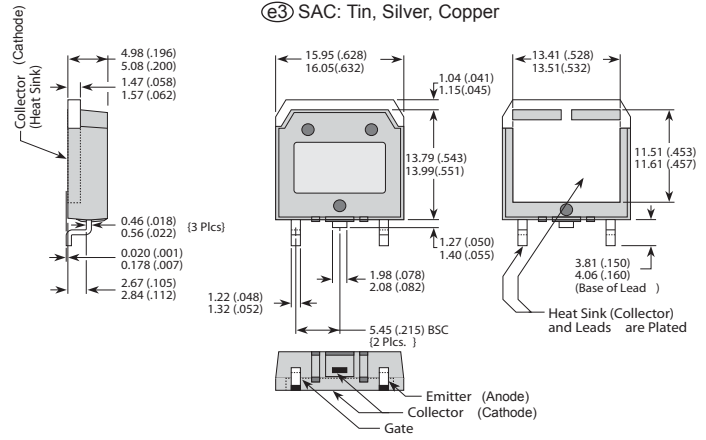

Dimensions in Millimeters (Inches)