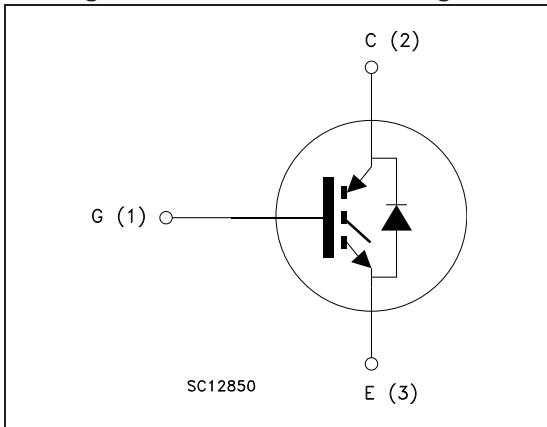

Figure 1. Internal schematic diagram



Features

- Low on-losses
- Low on-voltage drop ($V_{CE(sat)}$)
- High current capability
- IGBT co-packaged with ultrafast free-wheeling diode
- Low gate charge
- Ideal for soft switching application

Application

- Induction heating
- High frequency inverters
- UPS

Description

This IGBT utilizes the advanced PowerMESH™ process resulting in an excellent trade-off between switching performance and low on-state behavior.

Table 1. Device summary

Order code	Marking	Package	Packaging
STGW35NC120HD	GW35NC120HD	TO-247 long leads	Tube

Contents

1	Electrical ratings	3
2	Electrical characteristics	4
	2.1 Electrical characteristics (curves)	6
3	Test circuits	9
4	Package mechanical data	10
5	Revision history	12

1 Electrical ratings

Table 2. Absolute maximum ratings

Symbol	Parameter	Value	Unit
V_{CES}	Collector-emitter voltage ($V_{GE} = 0$)	1200	V
$I_C^{(1)}$	Continuous collector current at $T_C = 25\text{ °C}$	60	A
$I_C^{(1)}$	Continuous collector current at $T_C = 100\text{ °C}$	32	A
$I_{CL}^{(2)}$	Turn-off latching current	135	A
$I_{CP}^{(3)}$	Pulsed collector current	135	A
V_{GE}	Gate-emitter voltage	± 25	V
P_{TOT}	Total dissipation at $T_C = 25\text{ °C}$	235	W
I_F	Diode RMS forward current at $T_C = 25\text{ °C}$	30	A
I_{FSM}	Surge non repetitive forward current $t_p = 10\text{ ms}$ sinusoidal	100	A
T_j	Operating junction temperature	-55 to 150	°C

1. Calculated according to the iterative formula:

$$I_C(T_C) = \frac{T_{j(max)} - T_C}{R_{thj-c} \times V_{CE(sat)(max)}(T_{j(max)}, I_C(T_C))}$$

2. $V_{clamp} = 80\%$ of V_{CES} , $T_j = 125\text{ °C}$, $R_G = 10\ \Omega$, $V_{GE} = 15\text{ V}$
 3. Pulse width limited by max. junction temperature allowed

Table 3. Thermal data

Symbol	Parameter	Value	Unit
$R_{thj-case}$	Thermal resistance junction-case IGBT	0.53	°C/W
	Thermal resistance junction-case diode	1.5	°C/W
$R_{thj-amb}$	Thermal resistance junction-ambient	50	°C/W

2 Electrical characteristics

($T_j = 25\text{ °C}$ unless otherwise specified)

Table 4. Static

Symbol	Parameter	Test conditions	Min.	Typ.	Max.	Unit
$V_{(BR)CES}$	Collector-emitter breakdown voltage ($V_{GE} = 0$)	$I_C = 1\text{ mA}$	1200			V
$V_{CE(sat)}$	Collector-emitter saturation voltage	$V_{GE} = 15\text{ V}$, $I_C = 20\text{ A}$, $V_{GE} = 15\text{ V}$, $I_C = 20\text{ A}$, $T_j = 125\text{ °C}$		2.2 2.0	2.75	V V
$V_{GE(th)}$	Gate threshold voltage	$V_{CE} = V_{GE}$, $I_C = 250\mu\text{A}$	3.75		5.75	V
I_{CES}	Collector cut-off current ($V_{GE} = 0$)	$V_{CE} = 1200\text{ V}$ $V_{CE} = 1200\text{ V}$, $T_j = 125\text{ °C}$			500 10	μA mA
I_{GES}	Gate-emitter leakage current ($V_{CE} = 0$)	$V_{GE} = \pm 20\text{ V}$			± 100	nA
$g_{fs}^{(1)}$	Forward transconductance	$V_{CE} = 25\text{ V}$, $I_C = 20\text{ A}$		14		S

1. Pulse duration = 300 μs , duty cycle 1.5%

Table 5. Dynamic

Symbol	Parameter	Test conditions	Min.	Typ.	Max.	Unit
C_{ies}	Input capacitance	$V_{CE} = 25\text{ V}$, $f = 1\text{ MHz}$, $V_{GE} = 0$	-	2510	-	pF
C_{oes}	Output capacitance		-	175	-	pF
C_{res}	Reverse transfer capacitance		-	30	-	pF
Q_g	Total gate charge	$V_{CE} = 960\text{ V}$, $I_C = 20\text{ A}$, $V_{GE} = 15\text{ V}$	-	110	-	nC
Q_{ge}	Gate-emitter charge		-	16	-	nC
Q_{gc}	Gate-collector charge		-	49	-	nC

Table 6. Switching on/off (inductive load)

Symbol	Parameter	Test conditions	Min.	Typ.	Max.	Unit
$t_{d(on)}$	Turn-on delay time	$V_{CC} = 960\text{ V}$, $I_C = 20\text{ A}$	-	29	-	ns
t_r	Current rise time	$R_G = 10\ \Omega$, $V_{GE} = 15\text{ V}$,	-	11	-	ns
$(di/dt)_{on}$	Turn-on current slope	<i>Figure 17</i>	-	1820	-	A/ μ s
$t_{d(on)}$	Turn-on delay time	$V_{CC} = 960\text{ V}$, $I_C = 20\text{ A}$	-	27	-	ns
t_r	Current rise time	$R_G = 10\ \Omega$, $V_{GE} = 15\text{ V}$,	-	14	-	ns
$(di/dt)_{on}$	Turn-on current slope	$T_j = 125\text{ }^\circ\text{C}$ <i>Figure 17</i>	-	1580	-	A/ μ s
$t_{r(Voff)}$	Off voltage rise time	$V_{CC} = 960\text{ V}$, $I_C = 20\text{ A}$	-	90	-	ns
$t_{d(off)}$	Turn-off delay time	$R_G = 10\ \Omega$, $V_{GE} = 15\text{ V}$,	-	275	-	ns
t_f	Current fall time	<i>Figure 17</i>	-	312	-	ns
$t_{r(Voff)}$	Off voltage rise time	$V_{CC} = 960\text{ V}$, $I_C = 20\text{ A}$	-	150	-	ns
$t_{d(off)}$	Turn-off delay time	$R_G = 10\ \Omega$, $V_{GE} = 15\text{ V}$,	-	336	-	ns
t_f	Current fall time	$T_j = 125\text{ }^\circ\text{C}$ <i>Figure 17</i>	-	592	-	ns

Table 7. Switching energy (inductive load)

Symbol	Parameter	Test conditions	Min.	Typ.	Max.	Unit
$E_{on}^{(1)}$	Turn-on switching losses	$V_{CC} = 960\text{ V}$, $I_C = 20\text{ A}$	-	1660	-	μ J
$E_{off}^{(2)}$	Turn-off switching losses	$R_G = 10\ \Omega$, $V_{GE} = 15\text{ V}$,		4438		μ J
E_{ts}	Total switching losses	<i>Figure 17</i>		6098		μ J
$E_{on}^{(1)}$	Turn-on switching losses	$V_{CC} = 960\text{ V}$, $I_C = 20\text{ A}$	-	3015	-	μ J
$E_{off}^{(2)}$	Turn-off switching losses	$R_G = 10\ \Omega$, $V_{GE} = 15\text{ V}$,	-	6900	-	μ J
E_{ts}	Total switching losses	$T_j = 125\text{ }^\circ\text{C}$ <i>Figure 17</i>	-	9915	-	μ J

1. E_{on} is the turn-on losses when a typical diode is used in the test circuit in figure 2. If the IGBT is offered in a package with a co-pack diode, the co-pack diode is used as external diode. IGBTs & Diode are at the same temperature (25 °C and 125 °C)

2. Turn-off losses include also the tail of the collector current

Table 8. Collector-emitter diode

Symbol	Parameter	Test conditions	Min.	Typ.	Max.	Unit
V_F	Forward on-voltage	$I_F = 20\text{ A}$	-	1.9	2.5	V
		$I_F = 20\text{ A}$, $T_C = 125\text{ }^\circ\text{C}$		1.7		V
t_{rr}	Reverse recovery time	$I_F = 20\text{ A}$, $V_R = 27\text{ V}$,	-	152	-	ns
Q_{rr}	Reverse recovery charge	$T_j = 125\text{ }^\circ\text{C}$, $di/dt = 100\text{ A}/\mu\text{s}$	-	722	-	nC
I_{rrm}	Reverse recovery current	<i>Figure 20</i>	-	9	-	A

2.1 Electrical characteristics (curves)

Figure 2. Output characteristics

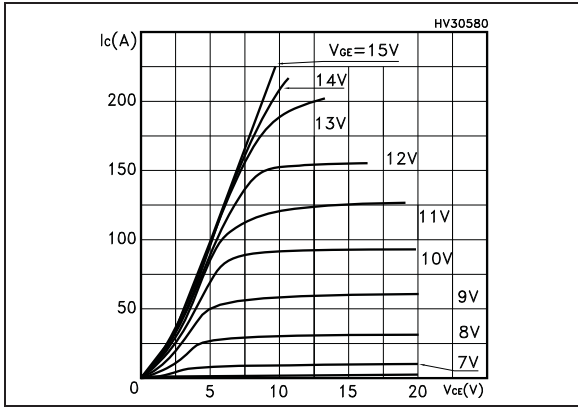

Figure 3. Transfer characteristics

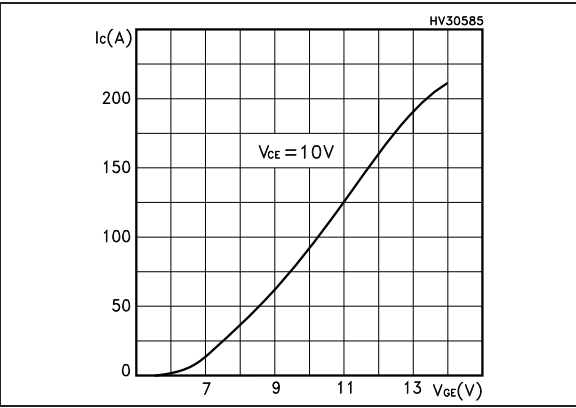

Figure 4. Transconductance

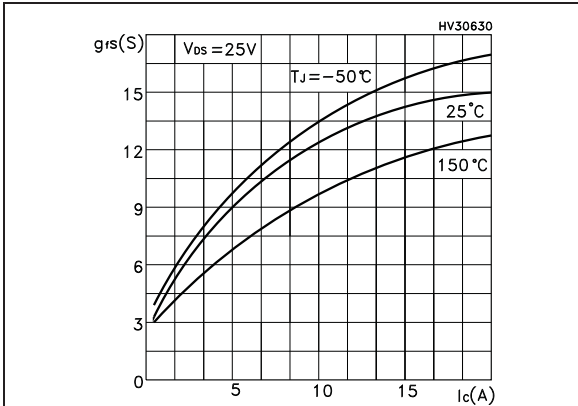

Figure 5. Collector-emitter on voltage vs. temperature

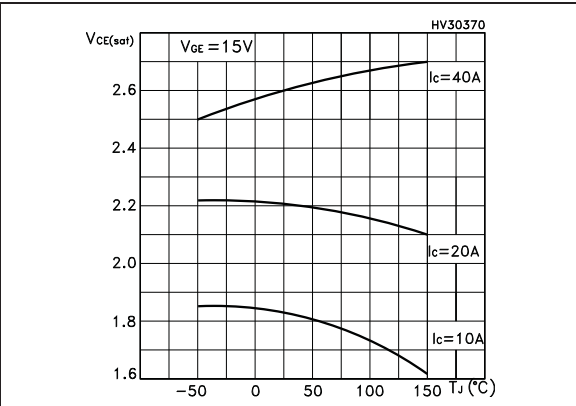

Figure 6. Gate charge vs. gate-source voltage

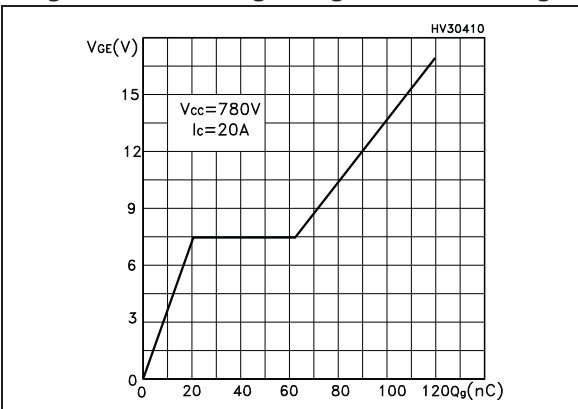

Figure 7. Capacitance variations

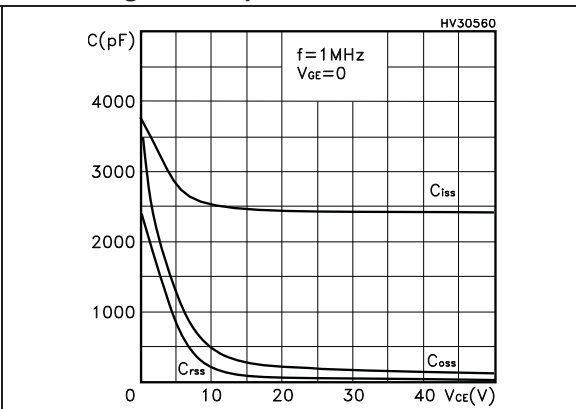

Figure 8. Normalized gate threshold voltage vs. temperature

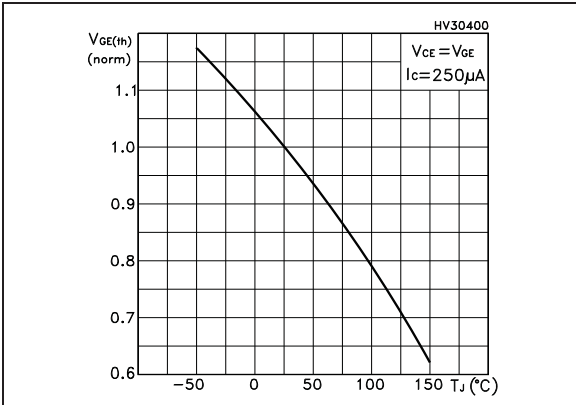

Figure 9. Collector-emitter on voltage vs. collector current

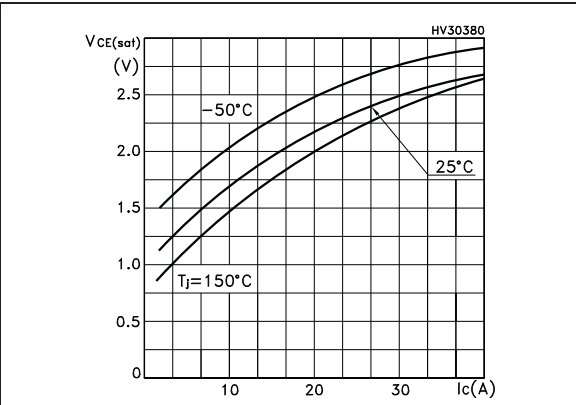

Figure 10. Normalized breakdown voltage vs. temperature

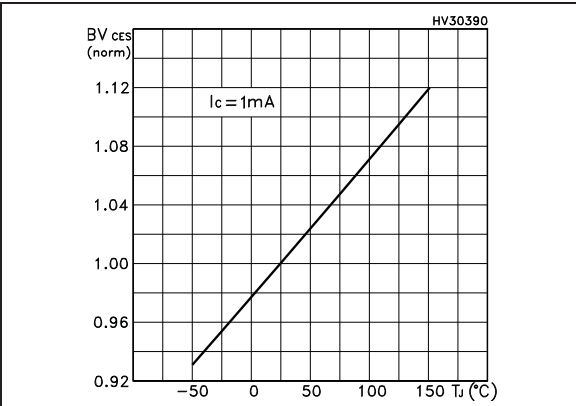

Figure 11. Switching losses vs. temperature

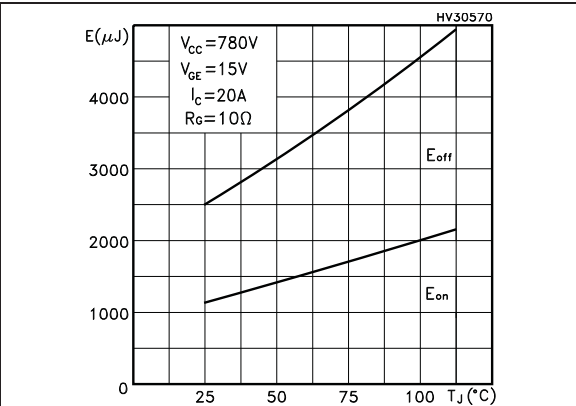

Figure 12. Switching losses vs. gate resistance Figure 13. Switching losses vs. collector current

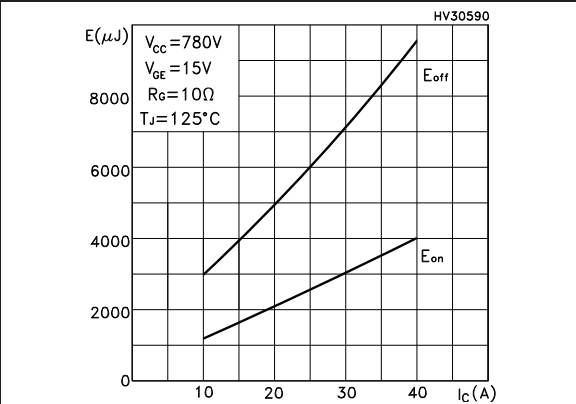
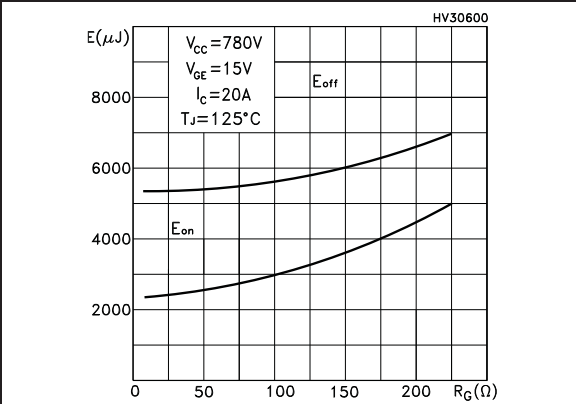

Figure 14. Thermal Impedance

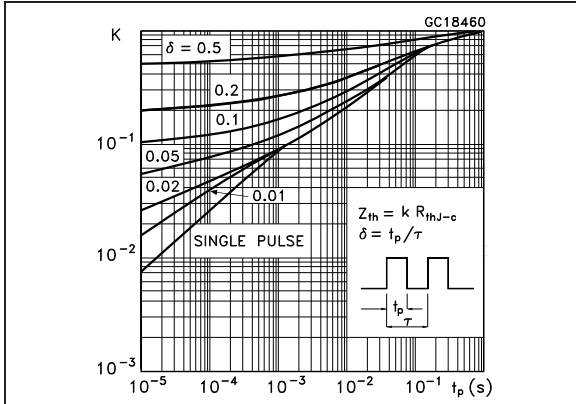

Figure 15. Reverse biased SOA

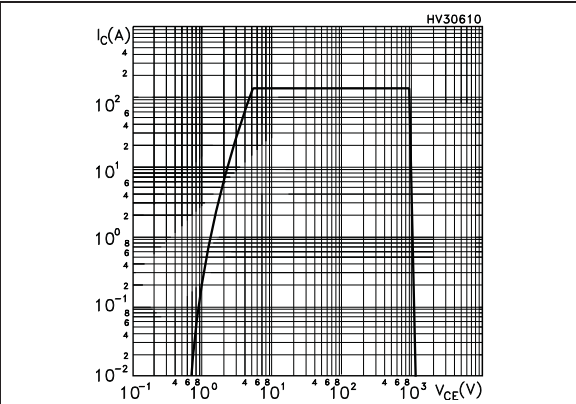
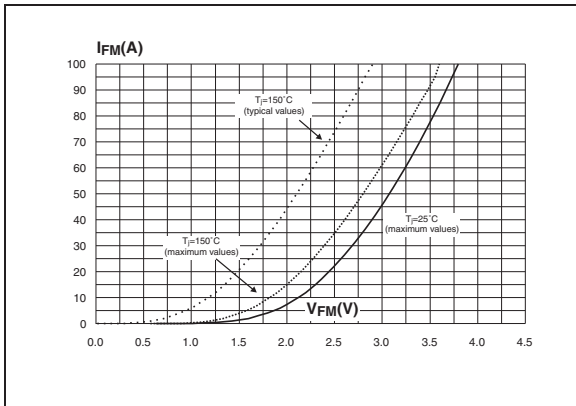

Figure 16. Forward voltage drop vs. forward current



3 Test circuits

Figure 17. Test circuit for inductive load switching

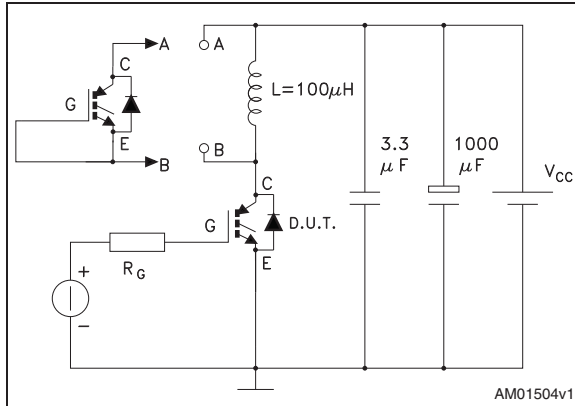

Figure 18. Gate charge test circuit

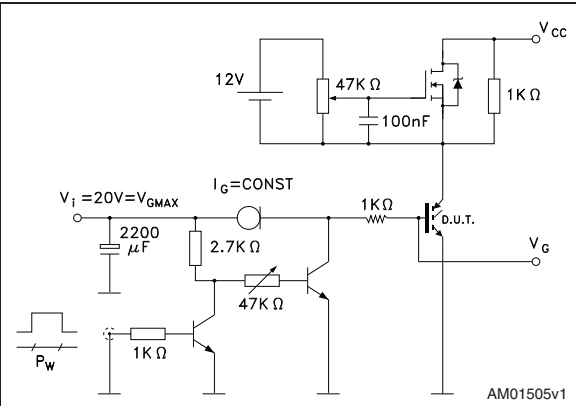

Figure 19. Switching waveform

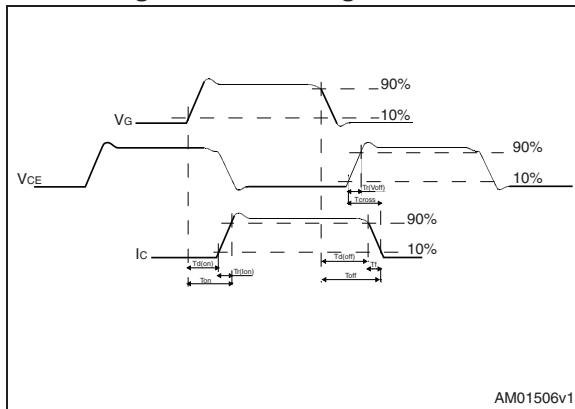
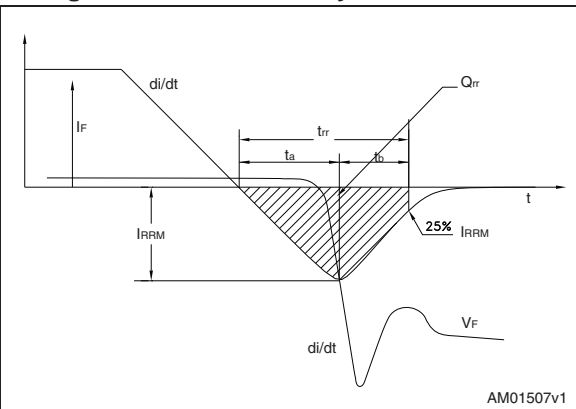

Figure 20. Diode recovery time waveform



4 Package mechanical data

In order to meet environmental requirements, ST offers these devices in different grades of ECOPACK® packages, depending on their level of environmental compliance. ECOPACK® specifications, grade definitions and product status are available at: www.st.com. ECOPACK is an ST trademark.

Table 9. TO-247 long leads mechanical data

Dim.	mm		
	Min.	Typ.	Max.
A	4.90		5.15
D	1.85		2.10
E	0.55		0.67
F	1.07		1.32
F1	1.90		2.38
F2	2.87		3.38
G	10.90 BSC		
H	15.77		16.02
L	20.82		21.07
L1	4.16		4.47
L2	5.49		5.74
L3	20.05		20.30
L4	3.68		3.93
L5	6.04		6.29
M	2.25		2.55
V		10°	
V1		3°	
V3		20°	
Dia.	3.55		3.66

Figure 21. TO-247 long leads drawing

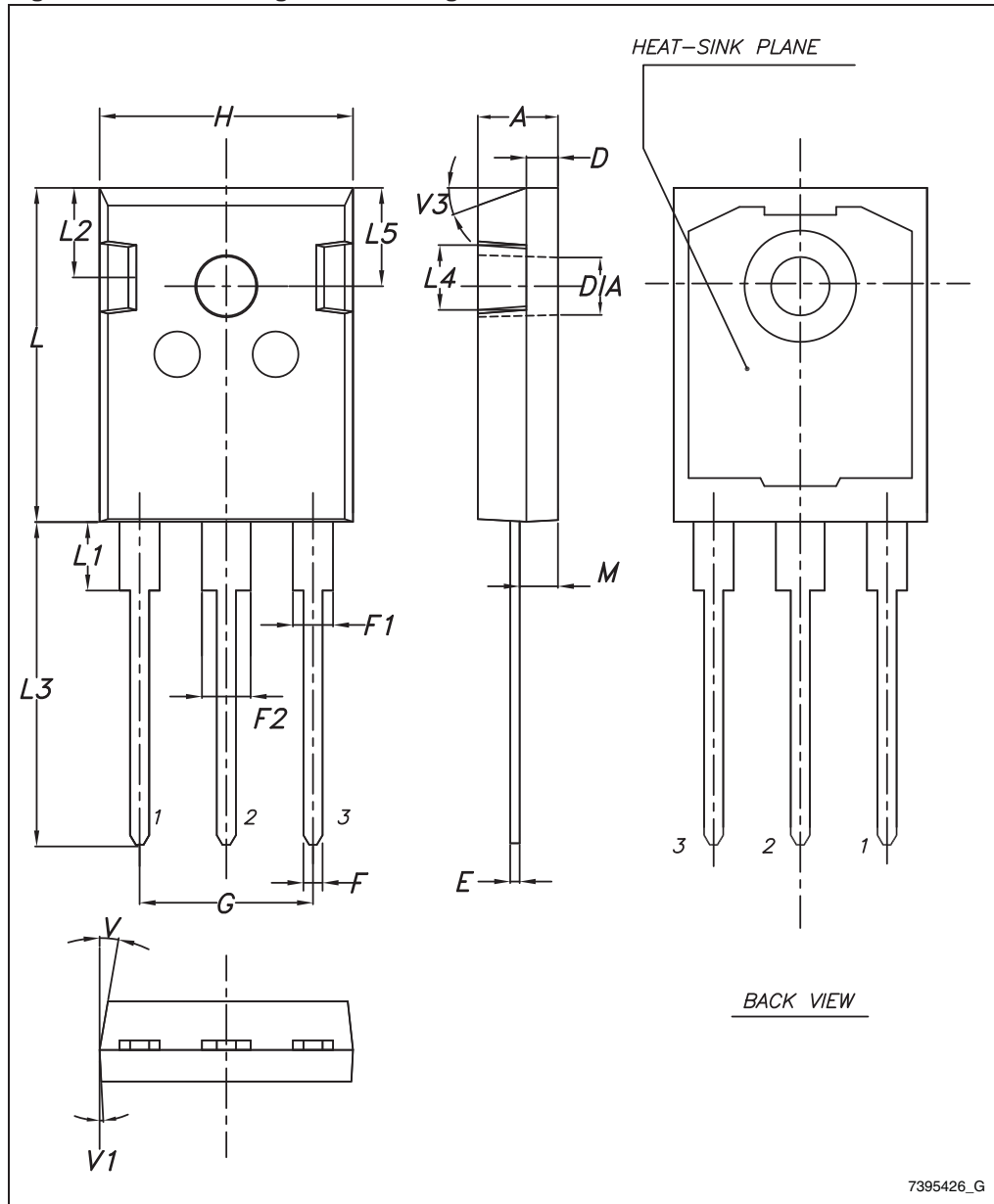

5 Revision history

Table 10. Document revision history

Date	Revision	Changes
25-Jan-2008	1	First issue.
07-May-2009	2	<i>Section 4: Package mechanical data</i> has been updated.
12-Dec-2013	3	Updated <i>Section 4: Package mechanical data</i> . Minor text changes.

Please Read Carefully:

Information in this document is provided solely in connection with ST products. STMicroelectronics NV and its subsidiaries ("ST") reserve the right to make changes, corrections, modifications or improvements, to this document, and the products and services described herein at any time, without notice.

All ST products are sold pursuant to ST's terms and conditions of sale.

Purchasers are solely responsible for the choice, selection and use of the ST products and services described herein, and ST assumes no liability whatsoever relating to the choice, selection or use of the ST products and services described herein.

No license, express or implied, by estoppel or otherwise, to any intellectual property rights is granted under this document. If any part of this document refers to any third party products or services it shall not be deemed a license grant by ST for the use of such third party products or services, or any intellectual property contained therein or considered as a warranty covering the use in any manner whatsoever of such third party products or services or any intellectual property contained therein.

UNLESS OTHERWISE SET FORTH IN ST'S TERMS AND CONDITIONS OF SALE ST DISCLAIMS ANY EXPRESS OR IMPLIED WARRANTY WITH RESPECT TO THE USE AND/OR SALE OF ST PRODUCTS INCLUDING WITHOUT LIMITATION IMPLIED WARRANTIES OF MERCHANTABILITY, FITNESS FOR A PARTICULAR PURPOSE (AND THEIR EQUIVALENTS UNDER THE LAWS OF ANY JURISDICTION), OR INFRINGEMENT OF ANY PATENT, COPYRIGHT OR OTHER INTELLECTUAL PROPERTY RIGHT.

ST PRODUCTS ARE NOT DESIGNED OR AUTHORIZED FOR USE IN: (A) SAFETY CRITICAL APPLICATIONS SUCH AS LIFE SUPPORTING, ACTIVE IMPLANTED DEVICES OR SYSTEMS WITH PRODUCT FUNCTIONAL SAFETY REQUIREMENTS; (B) AERONAUTIC APPLICATIONS; (C) AUTOMOTIVE APPLICATIONS OR ENVIRONMENTS, AND/OR (D) AEROSPACE APPLICATIONS OR ENVIRONMENTS. WHERE ST PRODUCTS ARE NOT DESIGNED FOR SUCH USE, THE PURCHASER SHALL USE PRODUCTS AT PURCHASER'S SOLE RISK, EVEN IF ST HAS BEEN INFORMED IN WRITING OF SUCH USAGE, UNLESS A PRODUCT IS EXPRESSLY DESIGNATED BY ST AS BEING INTENDED FOR "AUTOMOTIVE, AUTOMOTIVE SAFETY OR MEDICAL" INDUSTRY DOMAINS ACCORDING TO ST PRODUCT DESIGN SPECIFICATIONS. PRODUCTS FORMALLY ESCC, QML OR JAN QUALIFIED ARE DEEMED SUITABLE FOR USE IN AEROSPACE BY THE CORRESPONDING GOVERNMENTAL AGENCY.

Resale of ST products with provisions different from the statements and/or technical features set forth in this document shall immediately void any warranty granted by ST for the ST product or service described herein and shall not create or extend in any manner whatsoever, any liability of ST.

ST and the ST logo are trademarks or registered trademarks of ST in various countries.

Information in this document supersedes and replaces all information previously supplied.

The ST logo is a registered trademark of STMicroelectronics. All other names are the property of their respective owners.

© 2013 STMicroelectronics - All rights reserved

STMicroelectronics group of companies

Australia - Belgium - Brazil - Canada - China - Czech Republic - Finland - France - Germany - Hong Kong - India - Israel - Italy - Japan - Malaysia - Malta - Morocco - Philippines - Singapore - Spain - Sweden - Switzerland - United Kingdom - United States of America

www.st.com

