

RECEPTACLE

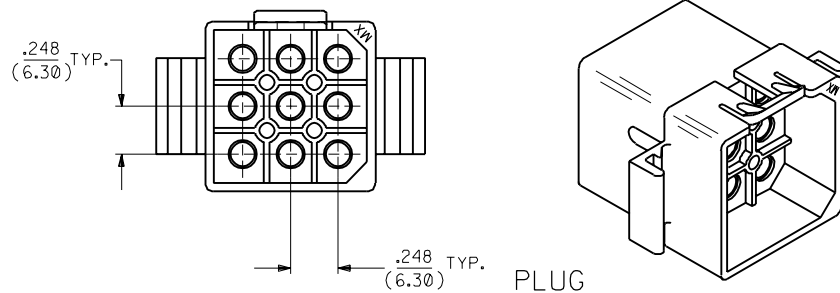
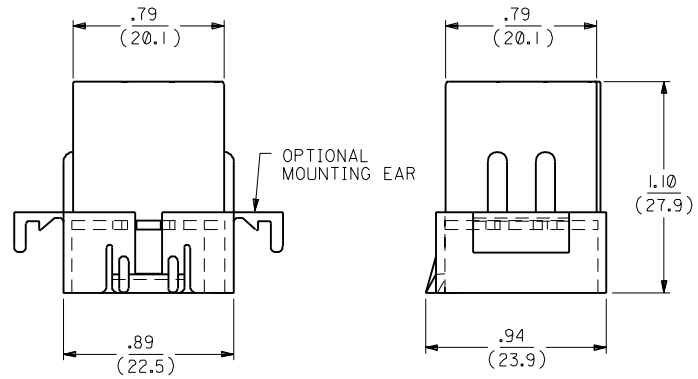
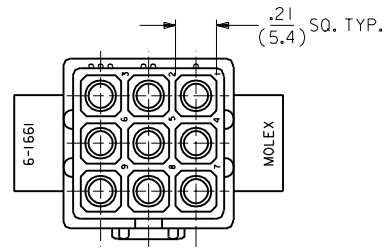

PLUG

1	2	1	I	OBsolete P/N UCR2002-0270 COMERCI 01/10/1
1	1	1	H	REVISED & REDRAWN ECR * U90255 KBW 04-25-89 RW
MFG.	SH.	REV.	LTR.	REVISIONS

DIMENSIONS SHOWN (METRIC) INCH
UNLESS OTHERWISE SPECIFIED
TOLERANCES ANGULAR ± 1/2°

	INCH	METRIC
3 PLACE	± .010	---
2 PLACE	± .014	± 0.25
1 PLACE	---	± 0.35

DRAFT WHERE APPLICABLE MUST REMAIN WITHIN DIMENSIONS

DRWG. BY: KBW CHK'D. BY: RW
APP'D. BY: RAS SCALE: 2: 1

FILE NAME: M1991-9
SHEET NO.: 1 OF 2
DATE: 04/25/89

TITLE: .093/(2.36) HOUSINGS
PLUG & RECEPTACLE
9 CIRCUIT, .248/(6.30)ϕ

MOLEX INCORPORATED
L15LE,ILL. 60532 U.S.A.

PART NO. DRWG. NO.
SEE CHART SD-1991-9*

THIS DRAWING CONTAINS INFORMATION THAT IS PROPRIETARY TO MOLEX INC. AND SHOULD NOT BE USED WITHOUT WRITTEN PERMISSION.

1991

PLUG		OBSOLETE
ORDER NO	ENG NO	
19-09-2091	1991-9P	
19-09-2092	1991-9P1	
19-09-7091	1991-9PBK	
19-09-7092	1991-9PIBK	
- -		

RECEPTACLE	
ORDER NO	ENG NO
19-09-1091	1991-9R
19-09-1092	1991-9R1
19-09-6091	1991-9RBK
19-09-6092	1991-9RIBK
- -	
- -	

LEGEND:

1991-9****

CIRCUIT SIZE

P = PLUG
R = RECEPTACLE

BLANK = WITH STANDARD EARS
1 = WITHOUT EARS
2 = WITH PREBENT EARS

COLOR:

BLANK = NATURAL COLOR
AM = AMBER BK = BLACK BU = BLUE
BN = BROWN GY = GRAY GN = GREEN
OR = ORANGE RD = RED YW = YELLOW

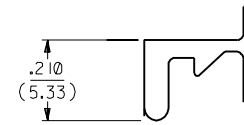

DETAIL A
STANDARD MOUNTING EAR
(SCALE 4:1)

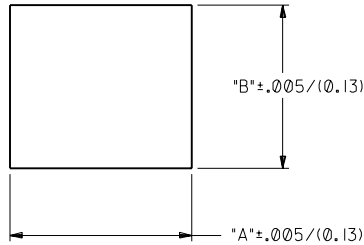
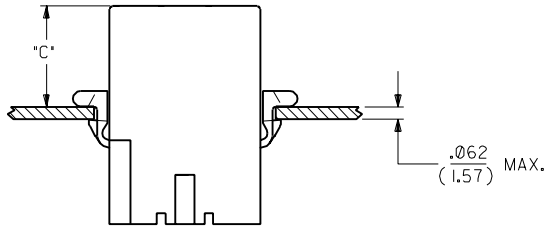

RECOMMENDED PANEL OPENING

HOUSING	DIM. "A"	DIM. "B"	"C" PREBENT EAR	"C" STANDARD EAR
PLUG	1.048/(26.60)	.910/(23.10)	.52/(13.2)	.51/(12.9)
RECEPT.	.946/(24.00)	.850/(21.60)	.54/(13.7)	.53/(13.5)

NOTES:

1. MOLEX PRODUCT SPEC 02-09 APPLIES.
2. MATERIAL: NYLON TYPE 6/6, 94V-2.
3. HOUSINGS FOR USE WITH MOLEX STANDARD .093/(2.36) TYPE TERMINALS.

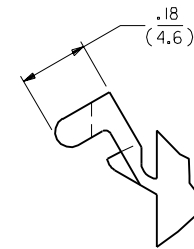
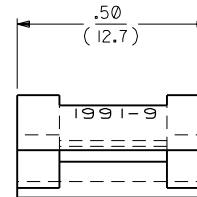

DETAIL B
PREBENT MOUNTING EAR
(SCALE 4:1)

DIMENSIONS SHOWN (METRIC) INCH	
UNLESS OTHERWISE SPECIFIED TOLERANCES ANGULAR ± 1/2°	
3 PLACE ± .010	---
2 PLACE ± .014	± 0.25
1 PLACE ---	± 0.35
DRAFT WHERE APPLICABLE MUST REMAIN WITHIN DIMENSIONS	
DRWG. BY: KBW	CHK'D. BY: RW
APP'D. BY: RAS	SCALE: 2:1

REVISIONS		REVISIONS	
LTR.		LTR.	
PART NO. SD-1991-9		DRWG. NO. SD-1991-9	
FILE NAME M1991-9		DIV. CP	
THIS DRAWING CONTAINS INFORMATION THAT IS PROPRIETARY TO MOLEX INC. AND SHOULD NOT BE USED WITHOUT WRITTEN PERMISSION.		DATE 04/25/89	

TITLE		REVISE ONLY ON CAD SYSTEM	
.093/(2.36) HOUSINGS PLUG & RECEPTACLE 9 CIRCUIT .248/(6.30)C		SHEET NO. 2	
MOLEX INCORPORATED 1151E.ILL. 60532 U.S.A.		DATE 04/25/89	
SEE CHART		SD-1991-9	