

1434-16 - VIEW FROM TOP (SOLD SEPERATELY)

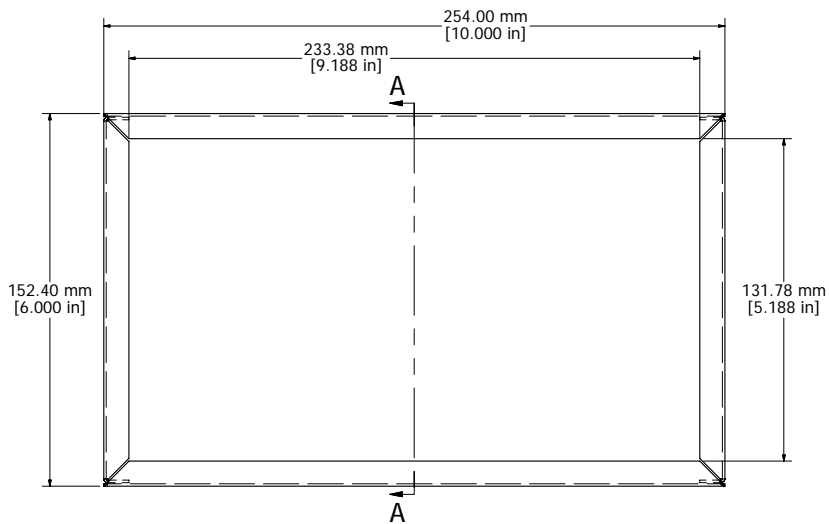

1444-16 - VIEW FROM TOP (SOLD SEPERATELY)

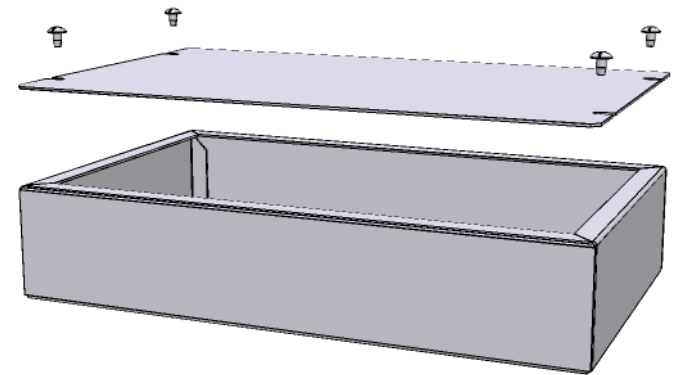
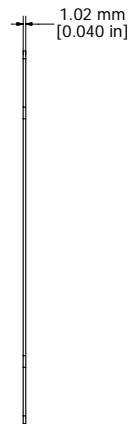
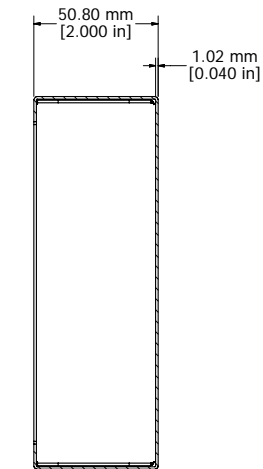

SECTION A-A

MATERIAL- 0.040" UNPAINTED ALUMINUM - ALL PARTS SOLD SEPERATELY
- CHASIS - 1444-16
- COVER - 1434-16
- 6 SCREWS (6-32 x 1/4 SHEET METAL SCREWS) - 1421J6

Contact Factory mjm@hammondmfg.com for quotes
 Enclosures can be Factory Modified (Milling, Drilling, Printing etc.)
 Solid models of this enclosure available in STEP or IGES.



**HAMMOND
 MANUFACTURING™**

1444-16

www.hammondmfg.com