

# ISL8115EVAL1Z Synchronous Buck Converter User Guide

## Introduction

The ISL8115EVAL1Z is a Synchronous Buck Converter implementing Intersil's wide input range PWM controller ISL8115. Utilizing voltage mode control with input feed-forward, the ISL8115EVAL1Z maintains a constant loop gain for optimal transient response, especially for applications with a wide input voltage range. For a more detailed description of the ISL8115 functionality, refer to the [ISL8115 data sheet](#).

This application note includes the test setup, typical performance waveforms, schematic, layout and Bill of Materials (BOM).

## Evaluation Board Specifications

**TABLE 1. EVALUATION BOARD ELECTRICAL SPECIFICATIONS**

SPEC	DESCRIPTION	MIN	TYP	MAX	UNIT
V <sub>IN</sub>	Board Input Range	10	12	15	V
V <sub>OUT</sub>	Output Voltage		1.5		V
I <sub>OUT</sub>	Output Rated Current		30		A
I <sub>OC</sub>	Overcurrent Threshold		32		A
F <sub>sw</sub>	Switch Frequency		220		kHz
Input UVP	Rising threshold		9.7		V
	Falling threshold		9.2		V
η	Efficiency at 50% load		90.88		%

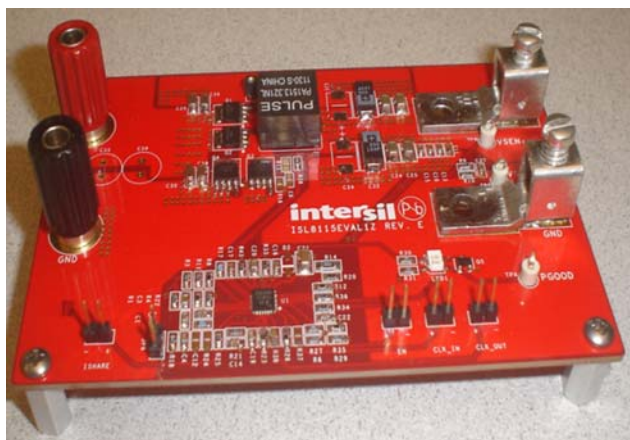

**FIGURE 1. ISL8115EVAL1Z EVALUATION BOARD**

## ISL8115 Key Features

- Wide V<sub>IN</sub> range operation: 2.97V to 36V; up to 5.5V output and 30A load current per phase.
- Fast transient response
  - Voltage-mode PWM leading-edge modulation with non-linear control
  - Input voltage feed-forward
- Integrated 5V high speed 4A MOSFET gate drivers
  - Internal bootstrap diode
- Oscillator programmable from 150kHz to 1.5MHz
  - Frequency synchronization to external clock signal
- Diode emulation mode for light load efficiency improvement
- Output OVP/UVP; OCP and OTP
- Power-good open drain output
- Adjustable soft-start
- Pre-bias start-up function
- Excellent output voltage regulation
  - 0.6V ±1.0% internal reference (-40 °C~125 °C)
  - 0.6V ±0.7% internal reference (-40 °C~105 °C)
  - Differential voltage sensing

## Applications

- Power supply for datacom/telecom and POL
- Wide input voltage range buck regulators
- High current density power supplies RF power amplifier bias compensation

## Recommended Equipment

- Input power source up to 15V supply voltage with 60W power supply ability
- Electronic load with 50W power sinking ability
- Voltmeters and ammeters
- 100MHz quad-trace oscilloscope

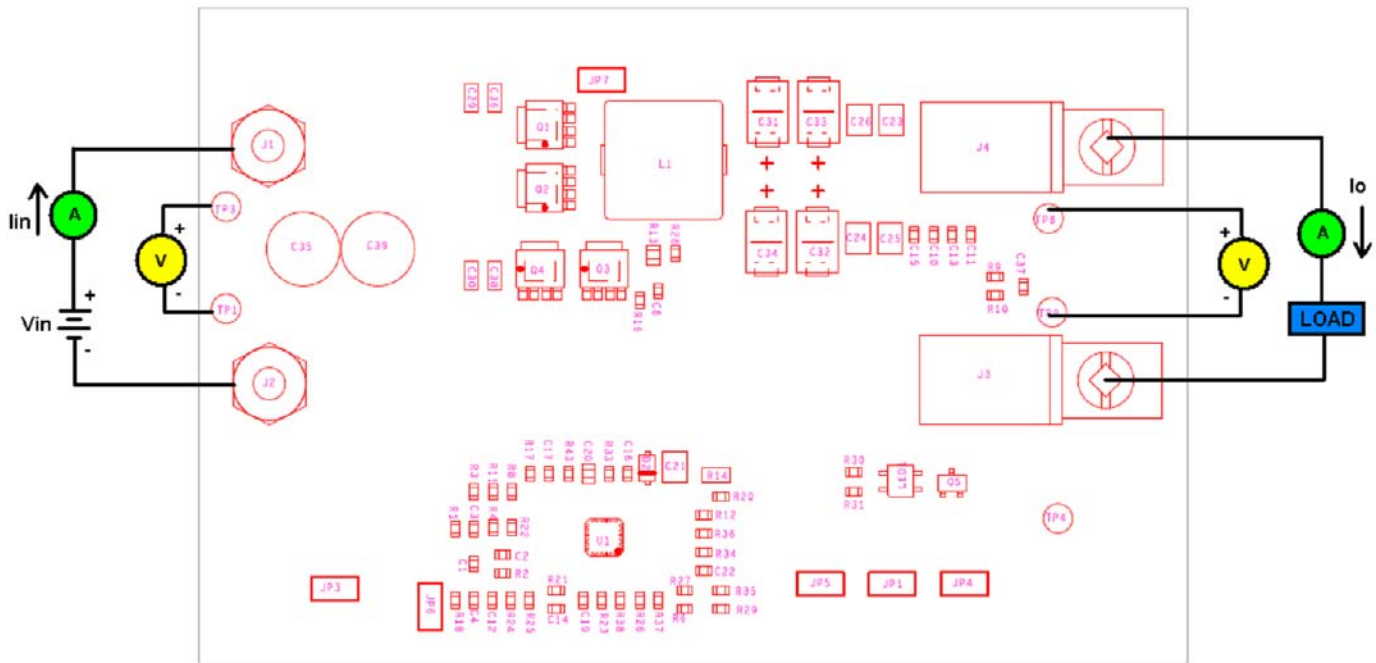

FIGURE 2. ISL8115EVAL1Z TEST SET-UP

## Quick Test Setup

1. Ensure that the Evaluation board is correctly connected to the power supply and the electronic load prior to applying any power. Please refer to Figure 2 for proper set-up.
2. Set the input voltage to 12V, turn on the power supply and observe output voltage. The output voltage should variation should be within 5%.
3. Adjust load current within 30A. The output voltage variation should be within 5%.
4. Use oscilloscope to observe output ripple voltage and phase node ringing. For accurate measurement, please refer to Figure 3 for proper set-up.

Note: Test points TP1; TP3; TP8; TP9 are for voltage measurement only. Do not allow high current through these test points.

## Probe Set-up

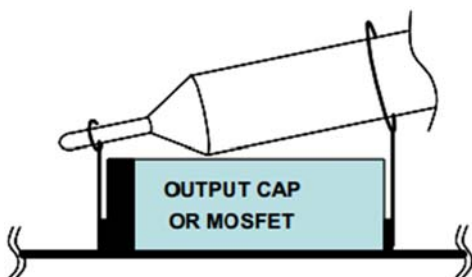

FIGURE 3. OSCILLOSCOPE PROBE SET-UP

## Design Guide

The ISL8115EVAL1Z is optimized for 10V to 15V input voltage range. However, the evaluation board can be modified to support multiple applications due to the customer requirements. Please refer to the datasheet for the detailed information.

## Output Voltage Adjustment

The output voltage can be set by the resistor R4, R1. In order to keep the existing compensation parameters unchanged, adjust R4 to set the output voltage by the following Equation 1:

$$R4 = \frac{0.6V \times R1}{V_{out} - 0.6V} \quad (EQ. 1)$$

VMON monitors the output for UVP and OVP, the resistor divider value of R11/R8 should be the same with the R1/R4.

## Synchronization

ISL8115EVAL1Z board can be synchronized with an external clock. Apply a clock signal (10% to 90% duty cycle) in the range of 150kHz to 1.5MHz to the FSET pin makes the internal frequency synchronized with the external clock. Please remove R27 when the sync function is implemented.

# Application Note 1881

## Typical Performance Curves Unless otherwise specified, the input voltage is 12V.

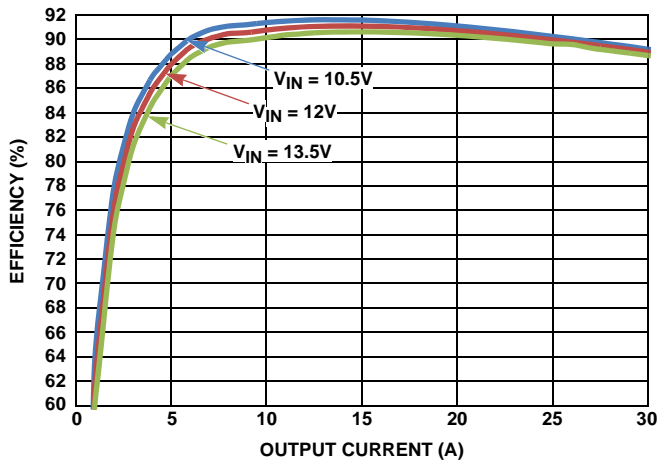

FIGURE 4. EFFICIENCY vs LOAD CURRENT AT CCM MODE

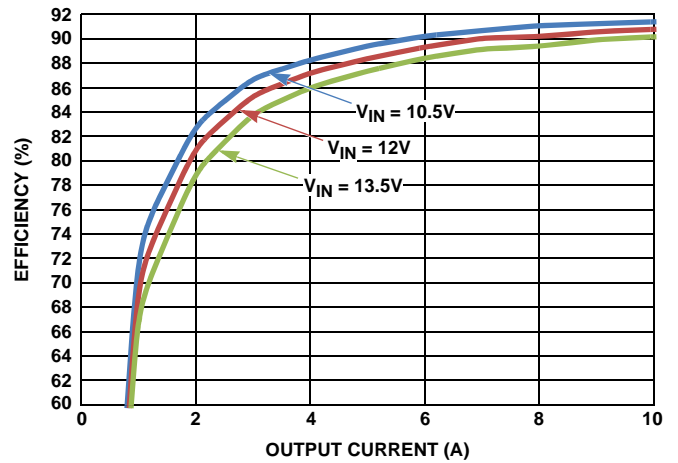

FIGURE 5. EFFICIENCY vs LOAD CURRENT AT DEM MODE

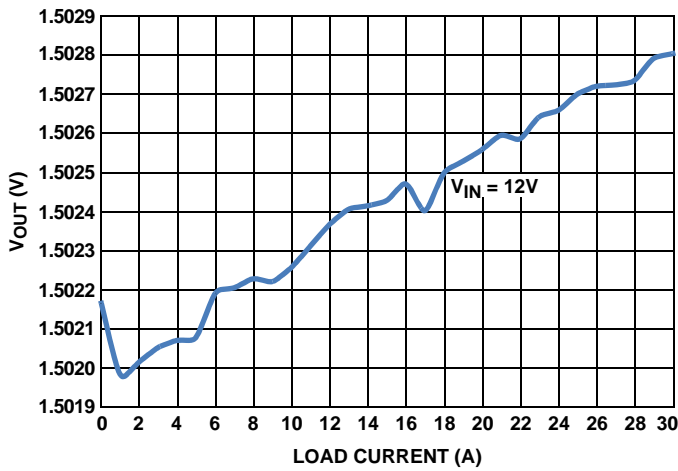

FIGURE 6.  $V_{OUT}$  LOAD REGULATION AT CCM MODE

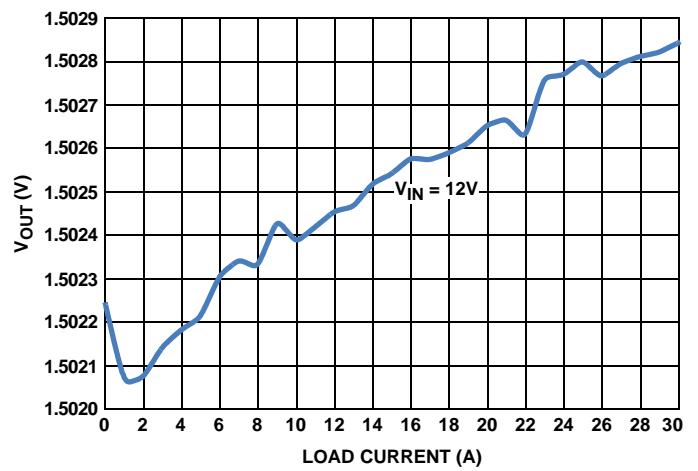

FIGURE 7.  $V_{OUT}$  LOAD REGULATION AT DEM MODE

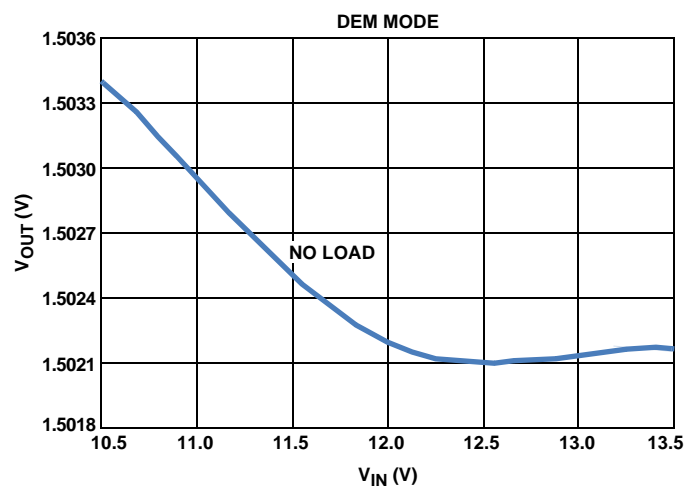
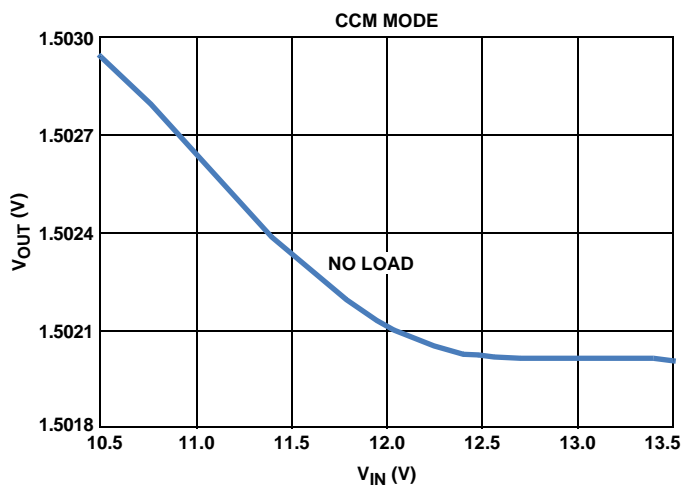

FIGURE 8. LINE REGULATION AT NO LOAD CONDITION

# Application Note 1881

## Typical Performance Curves Unless otherwise specified, the input voltage is 12V. (Continued)

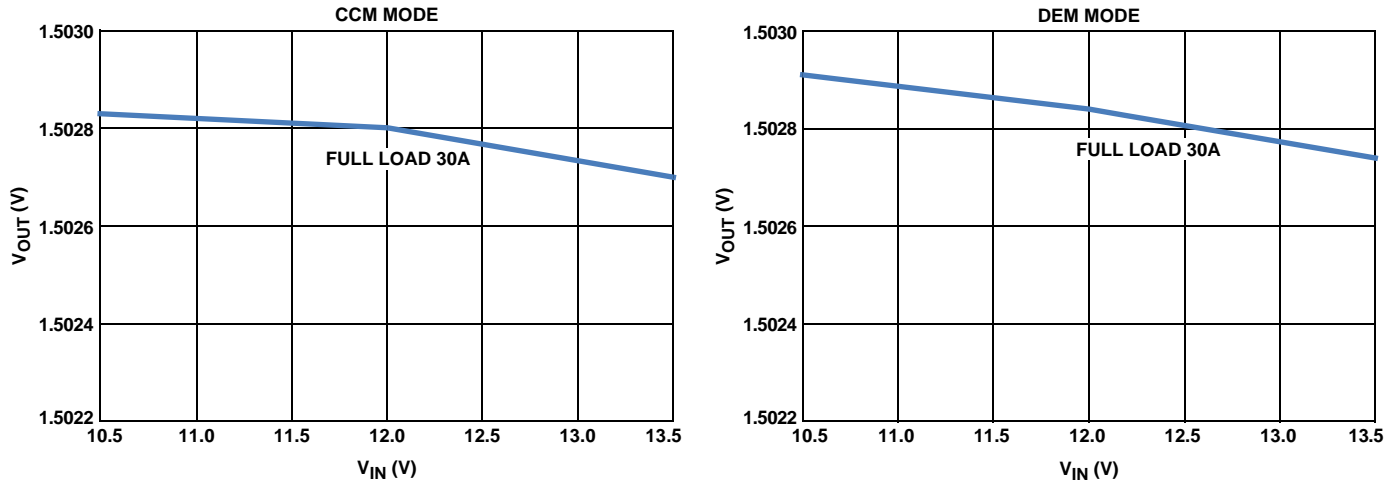

FIGURE 9. LINE REGULATION AT FULL LOAD CONDITION

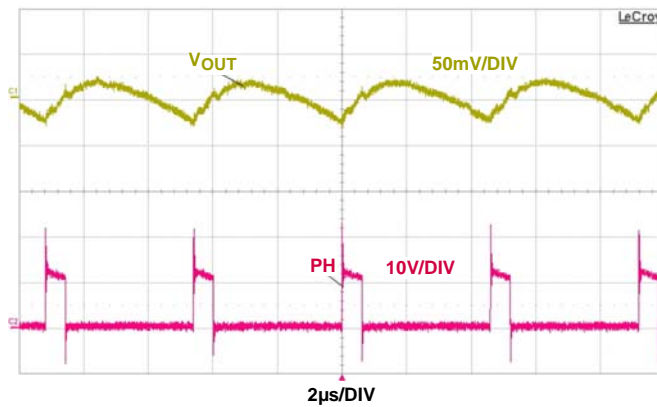

FIGURE 10. OUTPUT VOLTAGE RIPPLE AT 30A LOAD CONDITION

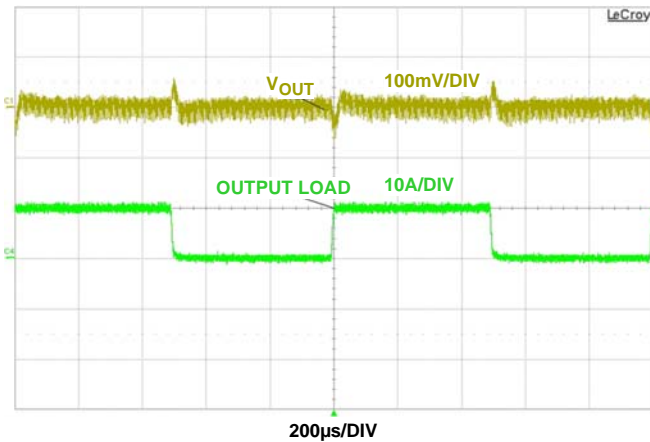

FIGURE 11. 0A-10A; 2A/ $\mu$ s AT CCM MODE

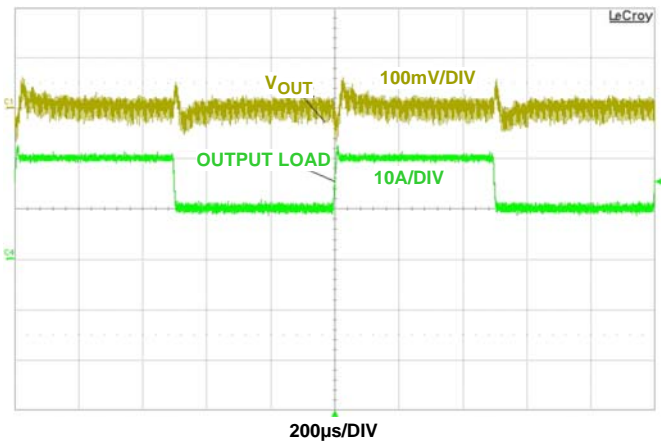

FIGURE 12. 10A -20A; 2A/ $\mu$ s AT CCM MODE

# Application Note 1881

## Typical Performance Curves Unless otherwise specified, the input voltage is 12V. (Continued)

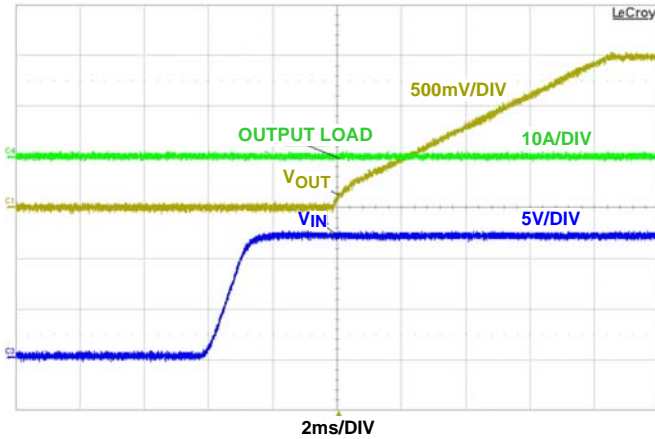

FIGURE 13. START-UP AT 0A LOAD CONDITION

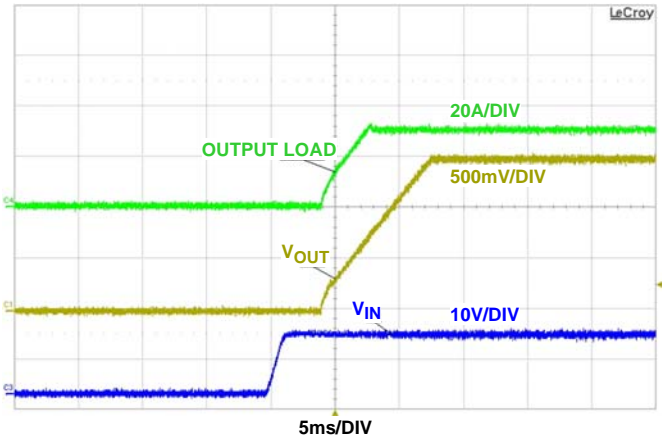

FIGURE 14. START-UP AT 30A LOAD CONDITION

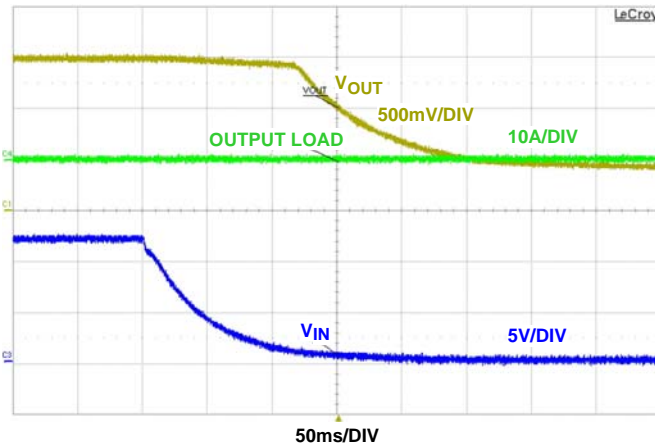

FIGURE 15. SHUTDOWN AT 0A LOAD CONDITION

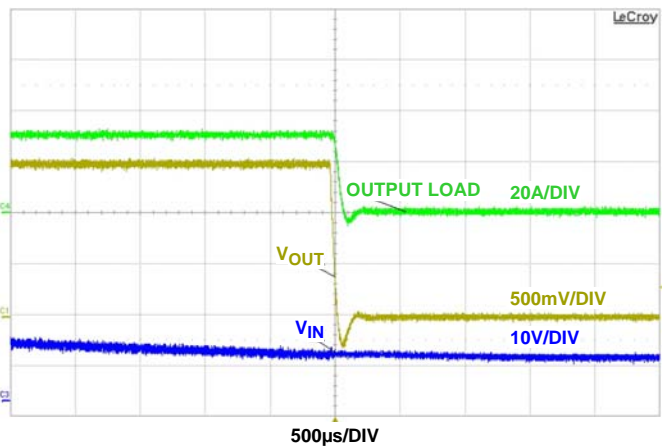

FIGURE 16. SHUTDOWN AT 30A LOAD CONDITION

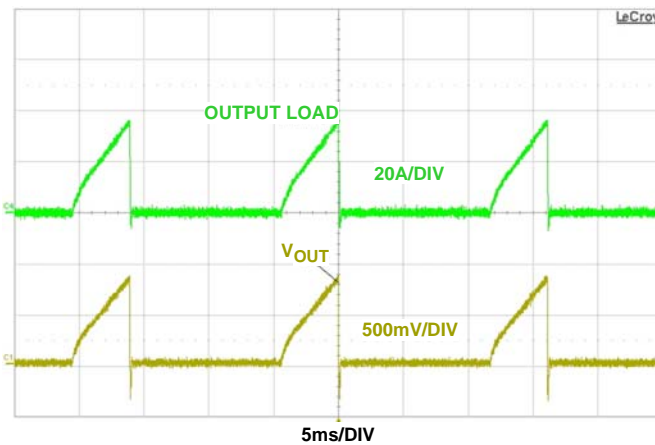

FIGURE 17. OCP AT 34A LOAD

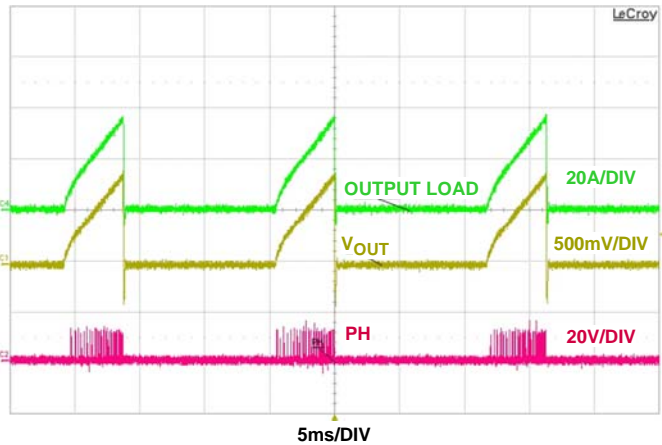
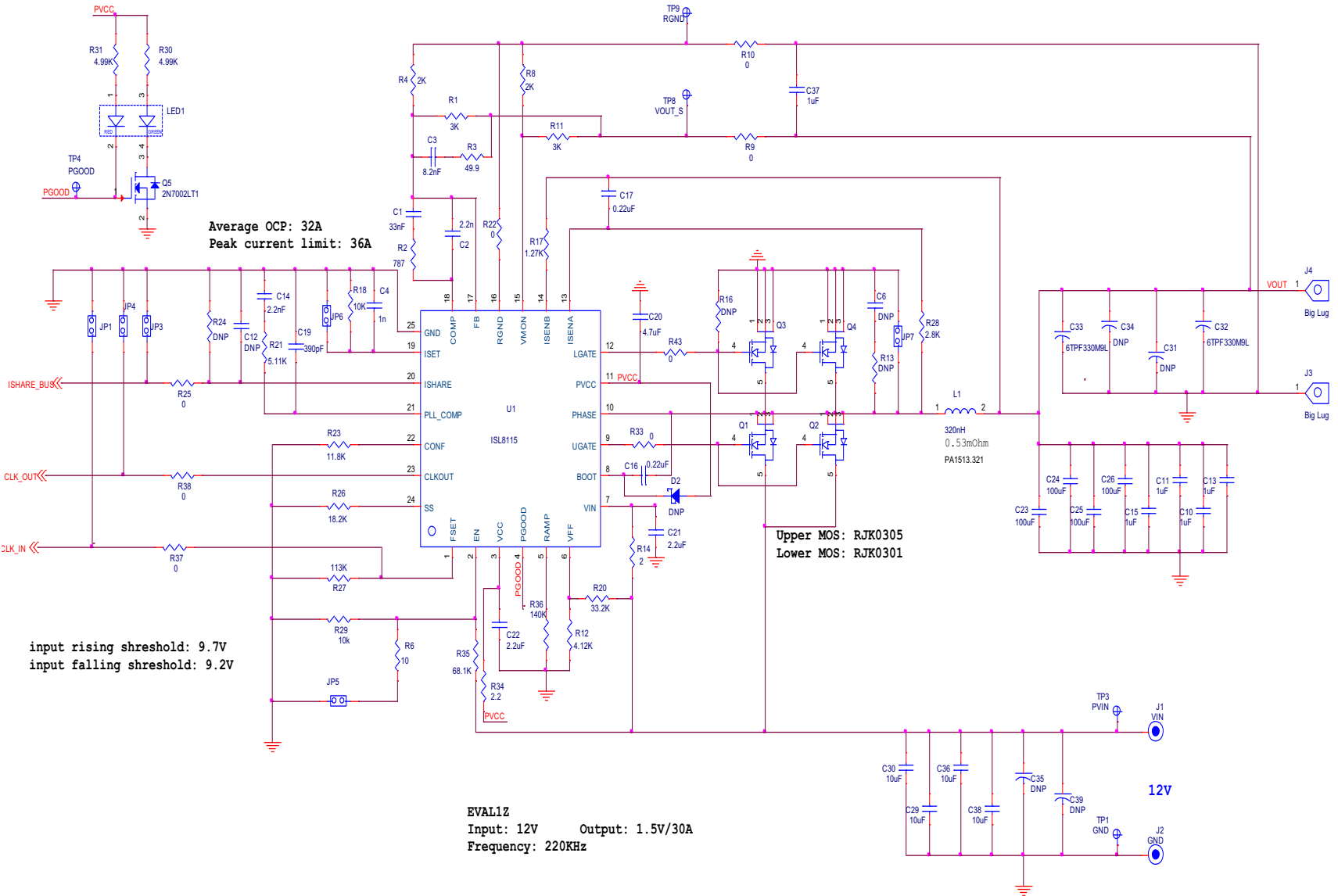

FIGURE 18. SHORT PROTECTION

# Schematic



# Application Note 1881

## Bill of Materials

QTY	REFERENCE	VALUE	DESCRIPTION	PART #	VENDOR
1	C1	33nF	CAP CER 0.033μF 50V 10% X7R 0603	Generic	Generic
1	C2	2.2n	CAP CER 2200pF 50V 5% NPO 0603	Generic	Generic
1	C3	8.2n	CAP CER 8200pF 50V 5% NPO 0603	Generic	Generic
1	C4	1n	CAP CER 1000pF 50V 5% NPO 0603	Generic	Generic
5	C6, C12, R13, R16, R24	DNP		Generic	Generic
5	C10, C11, C13, C15, C37	1μF	CAP CER 1μF 10V 10% X5R 0603	Generic	Generic
1	C14	2.2nF	CAP CER 2200pF 50V 5% NPO 0603	Generic	Generic
2	C16, C17	0.22μF	CAP CER 0.22μF 16V 10% X7R 0603	Generic	Generic
1	C19	390pF	CAP CER 390pF 50V 5% NPO 0603	Generic	Generic
1	C20	4.7μF	CAP CER 4.7μF 6.3V 10% X5R 0805	Generic	Generic
1	C21	2.2μF	CAP CER 2.2μF 25V 10% X7R 1210	C3225X7R1E225K/1.60	TDK
1	C22	2.2μF	CAP CER 2.2μF 6.3V 20% X5R 0603	Generic	Generic
4	C23, C24, C25, C26	100μF	CAP CER 100μF 6.3V 20% X5R 1210	C3225X5R0J107M250AC	TDK
4	C29, C30, C36, C38	10μF	CAP CER 10μF 50V 10% X5R 1206	C3216X5R1H106K160AB	TDK
2	C31, C34	DNP	CAP TANT 330μF 6.3V 20% 2917	6TPF330M9L	Panasonic
2	C32, C33	6TPF330M9L	CAP TANT 330μF 6.3V 20% 2917	6TPF330M9L	Panasonic
2	C35, C39	DNP	CAP OS-CON 270μF 16V	16SEPC270MX	Panasonic
1	D2	DNP	DIODE SCHOTTKY 40V SOD123		
6	JP1, JP3, JP4, JP5, JP6, JP7	Jumper	JUMPER PLUG 2POS DOUBLE ROW	XG8T-0231	Omron
1	J1	VIN	POST BINDING BANANA INSULATED RE	111-0707-001	Johnson Components
1	J2	GND	POST BINDING BANANA INSULATED BL	111-0703-001	Johnson Components
2	J3, J4	Big Lug	CONN- Big Lug TERMINAL POST	KPA8CTP	Burndy
1	LED1	LXA3025IGC-TR	LED	LNJ162C3XRA	Panasonic
1	L1	320nH	INDUCT PWR 320NH SMD	PA1513.321	Pulse
2	Q1, Q2	RJK0305	MOSFET N-CH 30V 30A 5-LFPAK	RJK0305DPB-00#J0	Renesas
2	Q3, Q4	RJK0328	MOSFET N-CH 30V 30A 5-LFPAK	RJK0305DPB-00#J0	Renesas
1	Q5	2N7002LT1	MOSFET N-CH 60V 115mA SOT-23	2N7002LT1	ON Semiconductor
2	R1, R11	3k	RES 3.00kΩ 1/10W 1% 0603 SMD	Generic	Generic
1	R2	787	RES 787Ω 1/10W 1% 0603 SMD	Generic	Generic
1	R3	49.9	RES 49.9Ω 1/10W 1% 0603 SMD	Generic	Generic
2	R4, R8	2k	RES 2.00kΩ 1/10W 1% 0603 SMD	Generic	Generic
1	R6	10	RES 10Ω 1/10W 1% 0603 SMD	Generic	Generic
8	R9, R10, R22, R25, R33, R37, R38, R43	0	RES 0.0Ω 1/10W JUMP 0603 SMD	Generic	Generic
1	R12	4.12k	RES 4.12kΩ 1/10W 1% 0603 SMD	Generic	Generic
1	R14	2	RES 2.00Ω 1/4W 1% 1206 SMD	Generic	Generic
1	R17	1.27k	RES 1.27kΩ 1/10W 1% 0603 SMD	Generic	Generic
2	R18, R29	10k	RES 10kΩ 1/10W 1% 0603 SMD	Generic	Generic
1	R20	33.2k	RES 33.2kΩ 1/10W 1% 0603 SMD	Generic	Generic
1	R21	5.11k	RES 5.11kΩ 1/10W 1% 0603 SMD	Generic	Generic

## Application Note 1881

### Bill of Materials (Continued)

QTY	REFERENCE	VALUE	DESCRIPTION	PART #	VENDOR
1	R23	11.8k	RES 11.8kΩ 1/10W 1% 0603 SMD	Generic	Generic
1	R26	18.2k	RES 18.2kΩ 1/10W 1% 0603 SMD	Generic	Generic
1	R27	113k	RES 113kΩ 1/10W 1% 0603 SMD	Generic	Generic
1	R28	2.8k	RES 2.8kΩ 1/10W 1% 0603 SMD	Generic	Generic
2	R30, R31	4.99K	RES 4.99kΩ 1/10W 1% 0603 SMD	Generic	Generic
1	R34	2.2	RES 2.2Ω 1/10W 1% 0603 smD	Generic	Generic
1	R35	68.1k	RES 68.1kΩ 1/10W 1% 0603 SMD	Generic	Generic
1	R36	140k	RES 140kΩ 1/10W 1% 0603 SMD	Generic	Generic
1	TP1	GND	Test point	SPCJ-123-01	Jolo
1	TP3	PVIN	Test point	SPCJ-123-01	Jolo
1	TP4	PGOOD	Test point	SPCJ-123-01	Jolo
1	TP8	VOUT_S	Test point	SPCJ-123-01	Jolo
1	TP9	RGND	Test point	SPCJ-123-01	Jolo
1	U1	ISL8115	Sync Buck PWM Controller 24Ld QFN	ISL8115FRTZ	Intersil



# Assembly Drawing

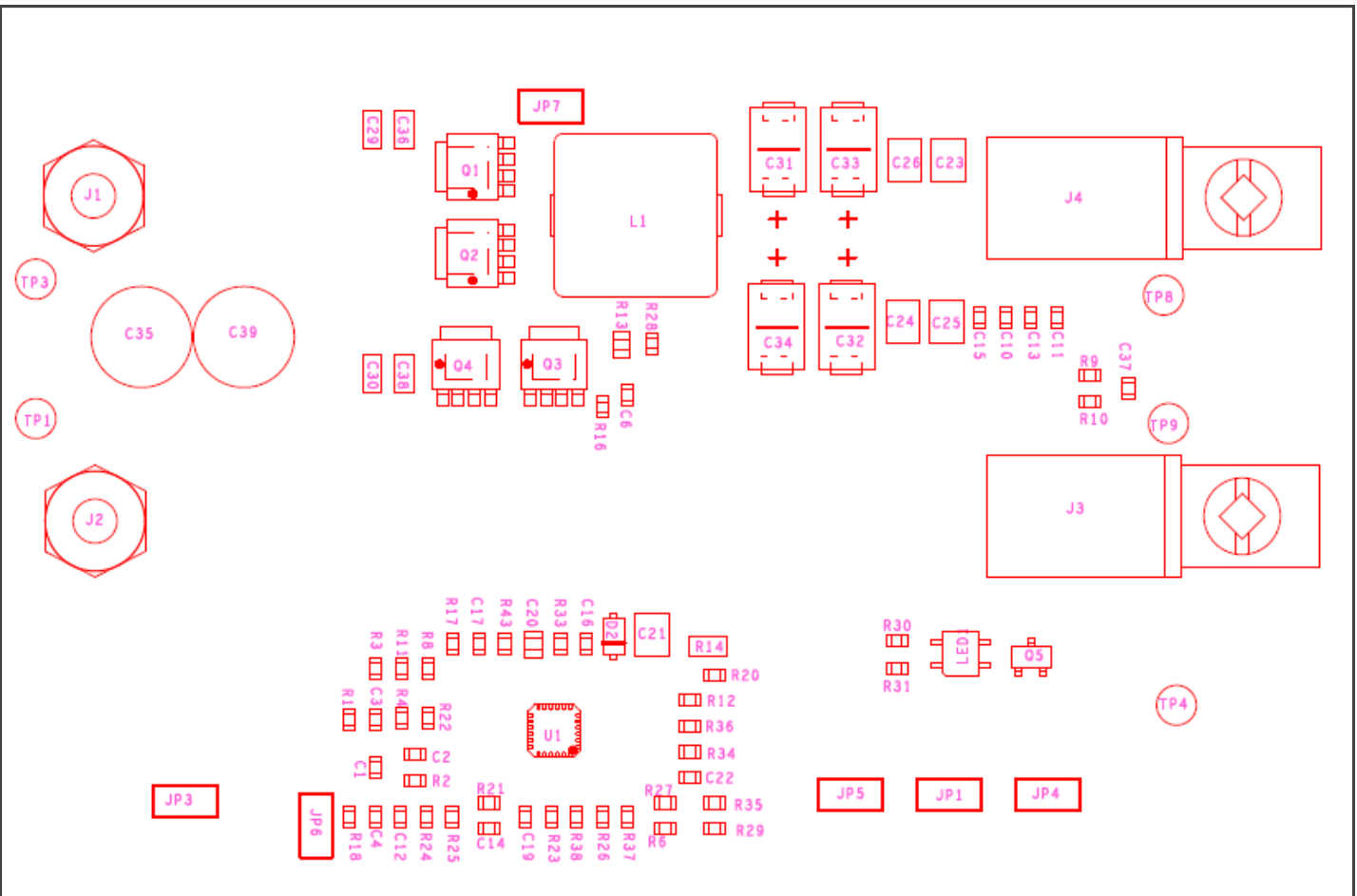

## PCB Layout

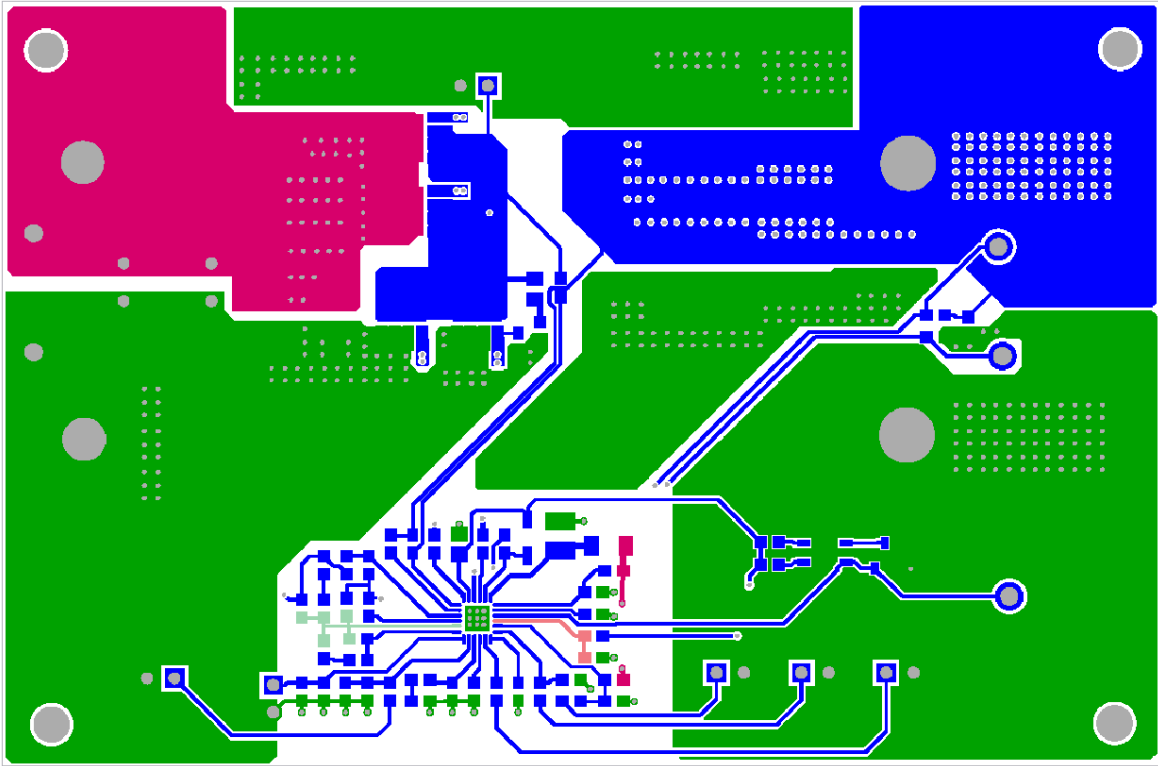

FIGURE 19. TOP LAYER

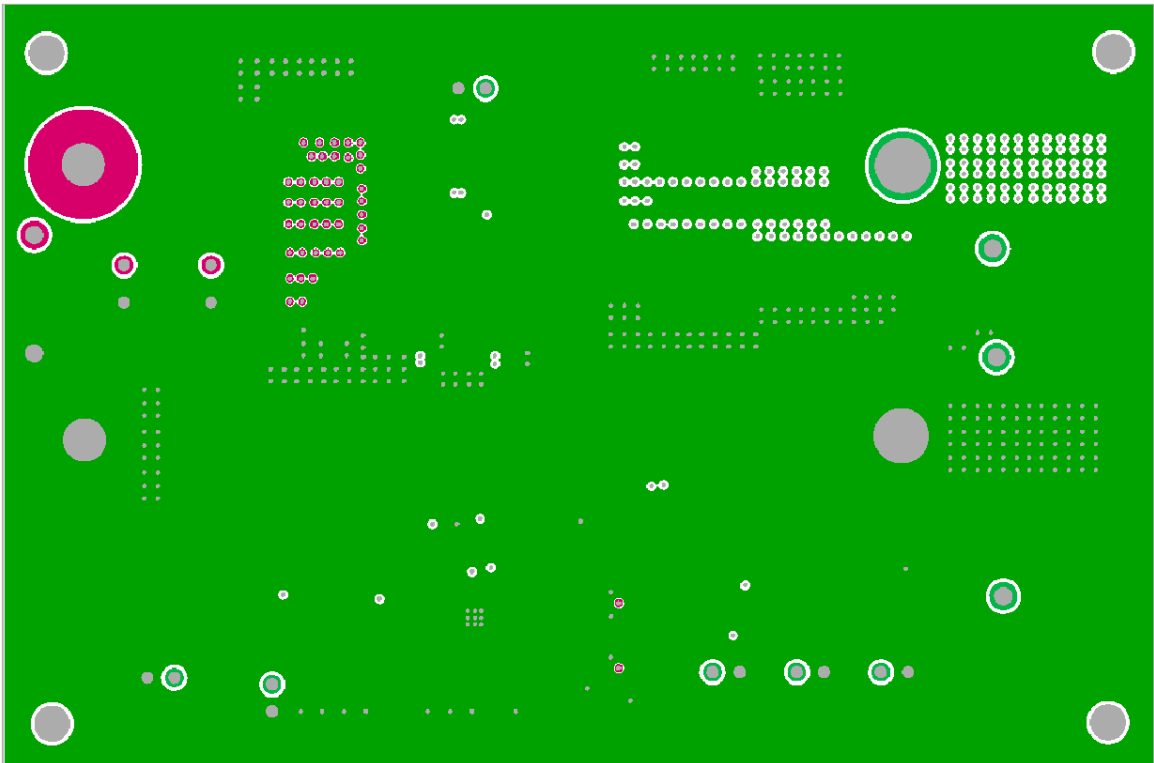

FIGURE 20. LAYER 2

PCB Layout (Continued)

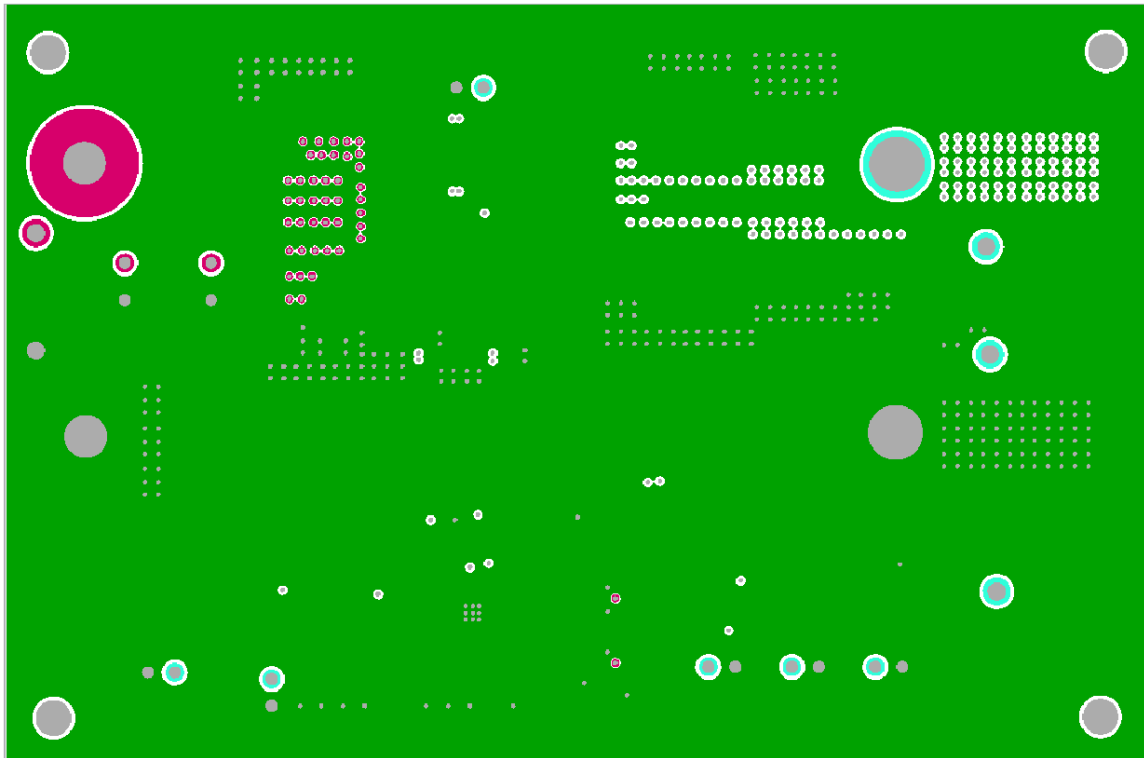

FIGURE 21. LAYER 3

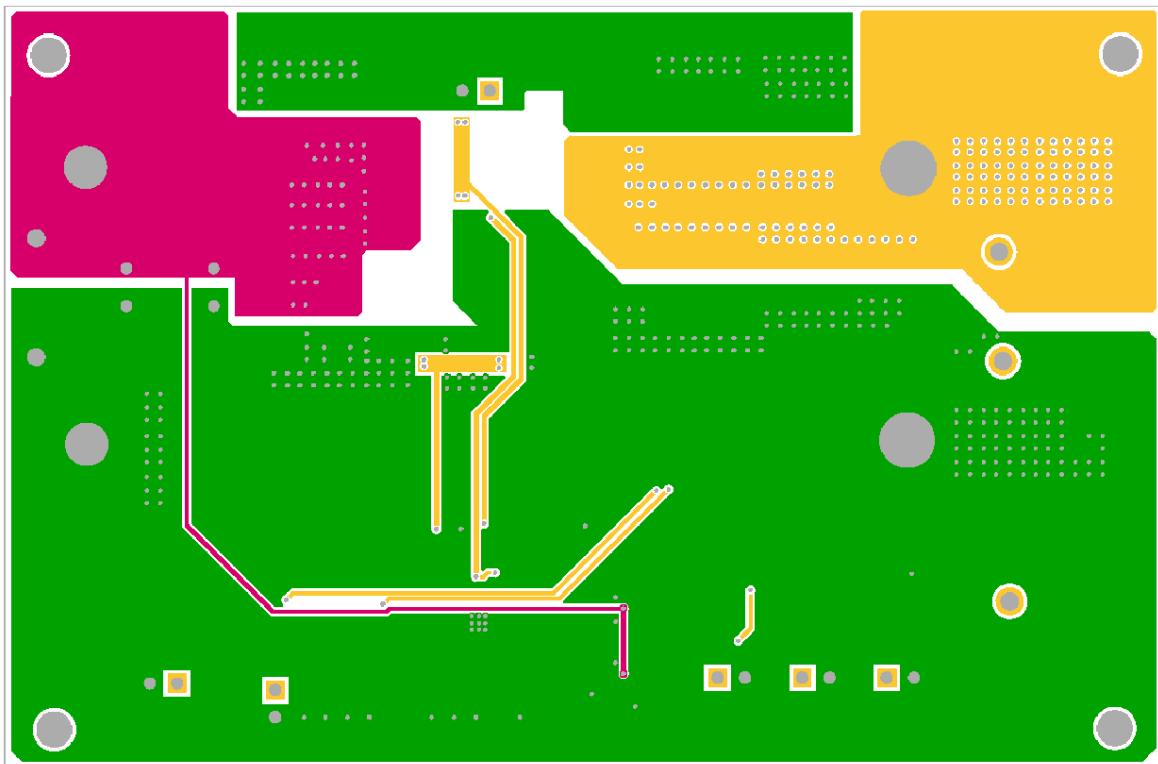

FIGURE 22. LAYER 4

Intersil Corporation reserves the right to make changes in circuit design, software and/or specifications at any time without notice. Accordingly, the reader is cautioned to verify that the Application Note or Technical Brief is current before proceeding.

For information regarding Intersil Corporation and its products, see [www.intersil.com](http://www.intersil.com)