

PLEASE CHECK WWW.MOLEX.COM FOR LATEST PART INFORMATION

Part Number: **0395229013**
Status: **Active**
Overview: Eurostyle™ Terminal Blocks
Description: 5.00mm Pitch Eurostyle Horizontal PCB Header, Surface Mount Compatible, Green Housing, 13 Circuits

Documents:

[3D Model](#) [Product Specification PS-39500-001-001 \(PDF\)](#)
[Drawing \(PDF\)](#) [RoHS Certificate of Compliance \(PDF\)](#)

Agency Certification

UL E48521

General

Product Family Terminal Blocks
 Series [39522](#)
 Application N/A
 Component Type PCB Header
 Overview [Eurostyle™ Terminal Blocks](#)
 Product Name ESE, Eurostyle Pluggable
 Type Euro Block
 UPC 822350459815

Physical

Circuits (Loaded) 13
 Entry Angle N/A
 Lock to Mating Part Yes
 Number of Rows 1
 Orientation Horizontal
 PC Tail Length 3.90mm
 PCB Thickness - Recommended 3.20mm
 Panel Mount No
 Pitch - Mating Interface 5.00mm
 Pitch - Termination Interface 5.00mm
 Polarized to Mating Part Yes
 Shrouded Closed Ends
 Stackable No
 Surface Mount Compatible (SMC) Yes
 Temperature Range - Operating -40°C to +140°C
 Wire Size AWG N/A

Electrical

Current - Maximum per Contact 15.0A
 Voltage - Maximum 300V

Solder Process Data

Lead-free Process Capability N/A

Material Info

Reference - Drawing Numbers

Product Specification PS-39500-001-001
 Sales Drawing SD-39522-001

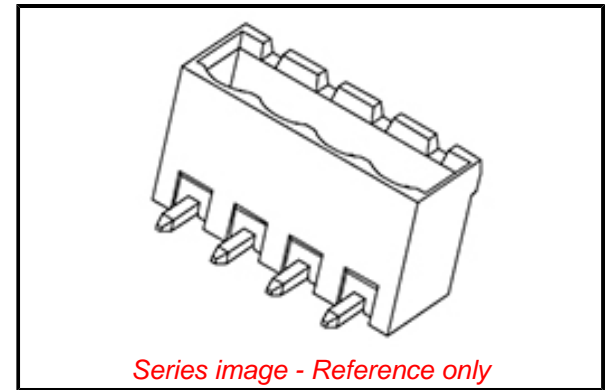

EU ELV

Not Relevant

EU RoHS

Not Reviewed

REACH SVHC

Not Reviewed

Halogen-Free

Status

Not Reviewed

Need more information on product environmental compliance?

Email productcompliance@molex.com
 Please visit the [Contact Us](#) section for any non-product compliance questions.

China ROHS Not Reviewed

ELV Not Relevant

RoHS Phthalates Not Reviewed

Search Parts in this Series

[39522](#) Series

Mates With

[39520](#) Horizontal Plug, [39523](#) Vertical Plug,
 Most 5.00mm Pitch Industry Standard Plugs