

10 9 8 7 6 5 4 3 2 1

F

E

D

C

B

A

F

E

D

C

B

A

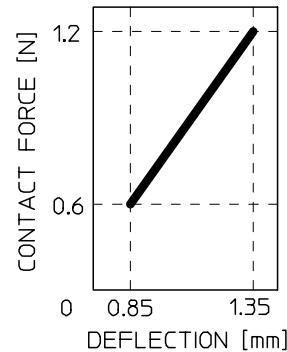
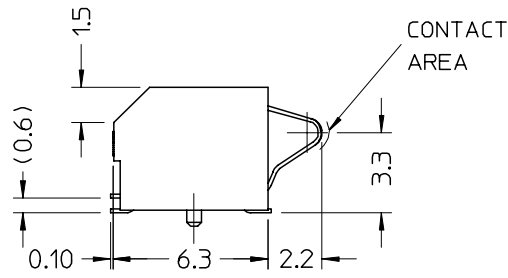
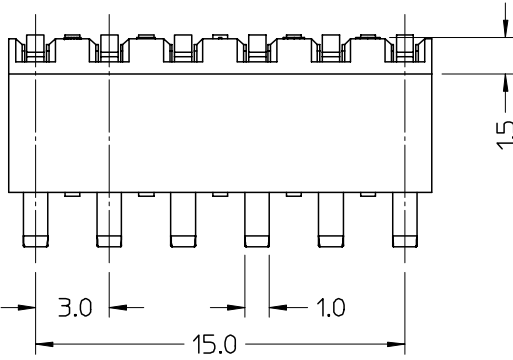
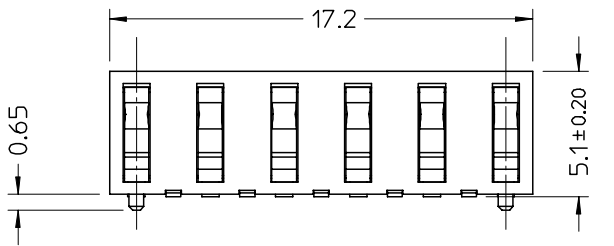
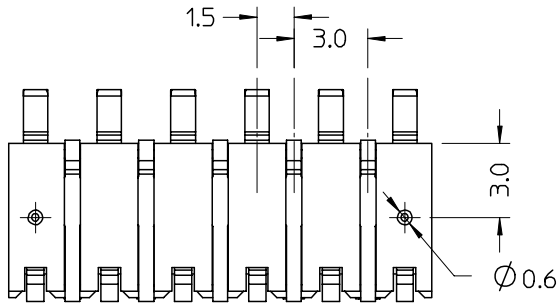

STABILIZER (x5)

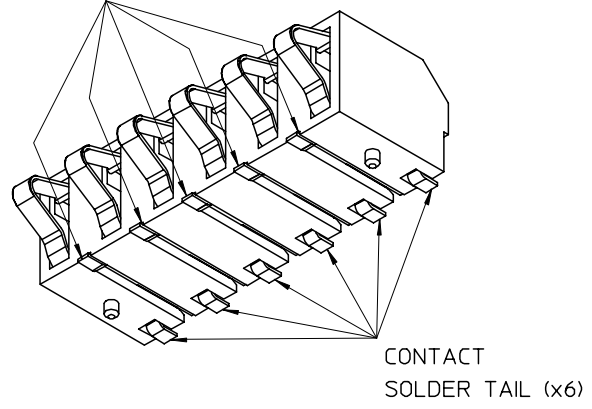

CONTACT SOLDER TAIL (x6)

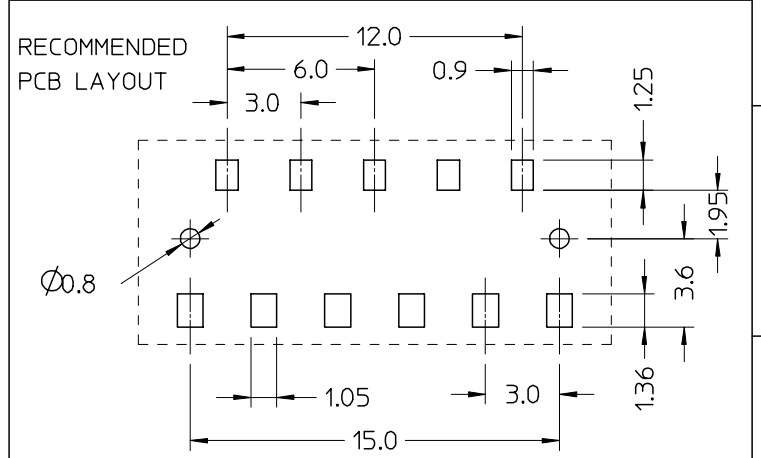

GENERAL TOLERANCES: ±0.05

NOTES:

- 1) MATERIALS:
 - HOUSING: PA6T 30%GF UL94 V-0 BLACK
 - CONTACTS: BERYLLIUM COPPER
 - STABILIZERS: BERYLLIUM COPPER
- 2) PLATING:
 - CONTACT AREA: 0.5µm MIN SELECTIVE Au
 - SOLDER TAIL : 3µm MIN SELECTIVE Sn
 - OVERALL: 1.27µm MIN Ni
- 3) PACKAGING: SEE DRAWING PK-94322-001

Std. Descr.: BATTERY CONNECTOR SMT 6 CKT

EC NO: Z2007-0007 DRWN:RSANDANO06/07/12 CHKD: 2006/07/12 APPR: SBARBIE 2006/07/19	QUALITY SYMBOLS ▴ - 0 ▽ - 0	GENERAL TOLERANCES (UNLESS SPECIFIED)		SCALE 5:1	DESIGN UNITS METRIC	FIRST ANGLE PROJECTION	REVISE ON CAD ONLY																			
		<table border="1"> <thead> <tr> <th></th> <th>mm</th> <th>INCH</th> </tr> </thead> <tbody> <tr> <td>4 PLACES</td> <td>±---</td> <td>±---</td> </tr> <tr> <td>3 PLACES</td> <td>±---</td> <td>±---</td> </tr> <tr> <td>2 PLACES</td> <td>±0.25</td> <td>±---</td> </tr> <tr> <td>1 PLACE</td> <td>±0.3</td> <td>±---</td> </tr> <tr> <td colspan="2">ANGULAR</td> <td>±---°</td> </tr> </tbody> </table>			mm	INCH	4 PLACES	±---	±---	3 PLACES	±---	±---	2 PLACES	±0.25	±---	1 PLACE	±0.3	±---	ANGULAR		±---°	DIMENSION STYLE MM ONLY		TITLE		
			mm	INCH																						
		4 PLACES	±---	±---																						
3 PLACES	±---	±---																								
2 PLACES	±0.25	±---																								
1 PLACE	±0.3	±---																								
ANGULAR		±---°																								
DRAFT WHERE APPLICABLE MUST REMAIN WITHIN DIMENSIONS		APPROVED BY SBARBIE 2006/07/12		DATE 2006/07/12		MATERIAL NO. 94322-5006																				
REV		DOCUMENT NO. SD-94322-001		SHEET NO. 1 OF 1		A3																				

9 8 7 6 5 4 3 2 1