

THE INFORMATION CONTAINED HEREON IS THE PROPERTY OF EMERSON NETWORK POWER, RECEIPT, POSSESSION OR TRANSMITTAL OF THIS DRAWING DOES NOT LICENSE OR IMPLY ANY RIGHT TO USE, SELL, PROTOTYPE OR MANUFACTURE FROM THIS INFORMATION. NO REPRODUCTIONS OR PUBLICATION OF THIS INFORMATION, IN WHOLE OR IN PART, SHALL BE MADE WITHOUT WRITTEN AUTHORIZATION FROM EMERSON NETWORK POWER.

DWG NO. 3-0272 SH 1

DASH NO	FIG NO	CONNECTOR TYPE	MODEL NO
-1	1	2-LUG	CBBJ79TL
-2	2	3-LUG	CBBJ79
-3	3	THREADED	CBBJ379
-4	4	4-LUG	CBBJ79FL
-5	1	2-LUG	CBBJ79TLS
-6	2	3-LUG	CBBJ79S
-7	3	THREADED	CBBJ379S
-8	4	4-LUG	CBBJ79FLS

REVISIONS			
REV	DESCRIPTION	DATE	APPROVED
C	ECO 12672	1/7/99	C.N.M.
D	ECO 52441	6/10/10	T. KOHLER

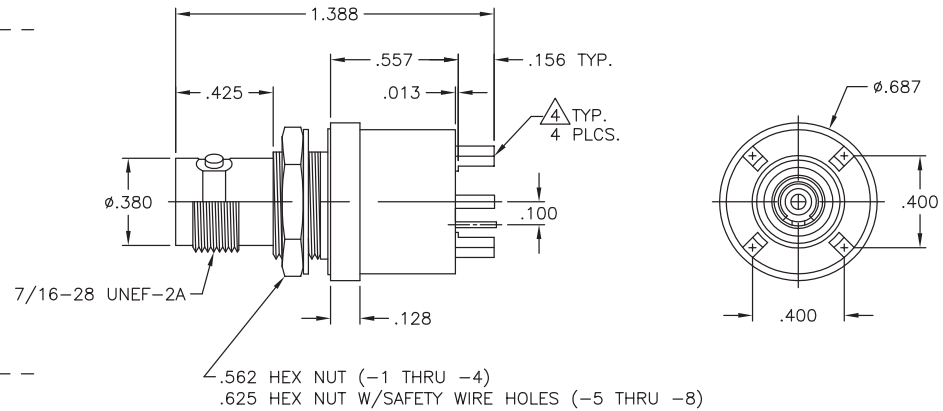
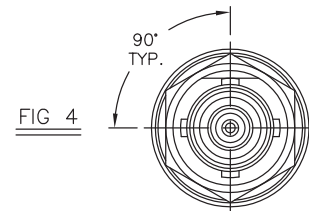
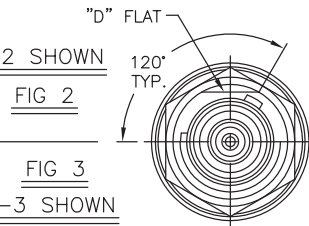
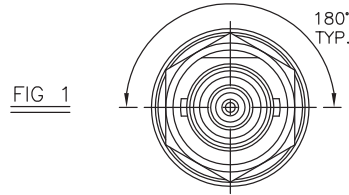

**RECOMMENDED
MTG HOLE PATTERN
SCALE 2:1**

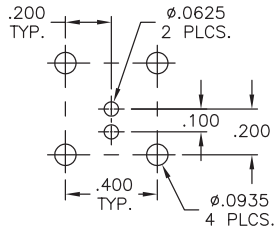

**RECOMMENDED
PANEL CUTOUT
SCALE 2:1**

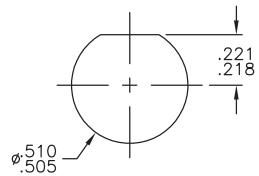

- PRE-TINNED, .0015 MAXIMUM THICKNESS WITH SN63 OR EQUIVALENT SOLDER, PER QQ-S-571, TO WITHIN .060 MAXIMUM OF SHOULDER, AFTER PLATING.
- MAXIMUM PANEL THICKNESS .109
- FEMALE 2/3/4 LUG & THREADED CONCENTRIC BOARD AND NON-INSULATED BULKHEAD MOUNT RECEPTACLE.

△ FINISH: TFS-1A (NICKEL)

SURFACE AREA (IN ²)	UNLESS OTHERWISE SPECIFIED DIMENSIONS ARE IN INCHES TOLERANCES ARE:		 cinch CONNECTIVITY SOLUTIONS a bel group	
	FRACTIONS	DECIMALS		
	±	.XX ±	±	
		.XXX ± .005		
		.XXXX ± .0010		
MATERIAL	SIGNATURES	DATE	CBBJ79/TL/FL/379	
	DRAWN BY		CBBJ79S/TLS/FLS/379S	
	CHECKED BY	6/17/10	SIZE	REV
FINISH	APPROVED BY		B	D
DO NOT SCALE DRAWING	APPROVED BY		CAGE CODE	DWG NO.
			14949	3-0272
			SCALE	DATE: 4/9/85
			2:1	SHEET 1 OF 2