



MAX16031 Evaluation Kit

General Description

The MAX16031 evaluation kit (EV kit) provides a proven printed-circuit board (PCB) layout that facilitates evaluation of the MAX16031 EEPROM-based system monitor with nonvolatile fault memory. This EV kit is a fully assembled and tested surface-mount board.

The EV kit includes an on-board USB-to-JTAG and I²C interface facilitating communications between the host PC and the MAX16031. A DAC connected to the monitoring inputs and the status LEDs connected to each programmable output make it easy to evaluate the various monitoring functions of the MAX16031.

This EV kit data sheet assumes basic familiarity with the MAX16031. Refer to the MAX16031/MAX16032 IC data sheet for more detailed information.

Features

- ◆ USB Interface to Host PC
- ◆ Easy-to-Use GUI Software
- ◆ Facilitates Programming of MAX16031s on Prototype Boards
- ◆ LEDs Indicate Each Output's State
- ◆ On-Board DAC Simulates Monitored Voltages
- ◆ Convenient Test Points and Headers for Easy Evaluation
- ◆ Fully Assembled and Tested

Ordering Information

PART	TYPE
MAX16031EVKIT+	EV Kit

+Denotes lead-free and RoHS-compliant.

Component List

DESIGNATION	QTY	DESCRIPTION
C1, C2, C4, C100, C108	5	1 μ F \pm 10%, 10V X5R ceramic capacitors (0805) TDK C2012X5R1A105K KEMET C0805C105K4PAC
C3, C5, C6	3	0.1 μ F \pm 10%, 25V X7R ceramic capacitors (0805) TDK C2012X7R1E104K Taiyo Yuden TMK212B104KT
C7	0	Not installed, capacitor (0805)
C101, C102, C103	3	0.1 μ F \pm 10%, 25V X7R ceramic capacitors (0603) TDK C1608X7R1E104K Taiyo Yuden TMK107BJ104KA
C104, C105, C106, C107	4	18pF \pm 5%, 50V C0G ceramic capacitors (0603) TDK C1608C0G1H180J Taiyo Yuden UMK107CG180JZ
C110	1	4.7 μ F \pm 20%, 6.3V X5R ceramic capacitor (0805) TDK C2012X5R0J475M Taiyo Yuden JMK212BJ475MG
C111	1	0.01 μ F \pm 10%, 50V X7R ceramic capacitor (0603) TDK C1608X7R1H103K Taiyo Yuden UMK107B103KZ

DESIGNATION	QTY	DESCRIPTION
C112, C113	2	2.2 μ F \pm 20%, 10V X5R ceramic capacitors (0805) TDK C2012X5R1A225M Taiyo Yuden LMK212BJ225MG
C114	1	33pF \pm 5%, 50V C0G ceramic capacitor (0603) TDK C1608C0G1H330J Taiyo Yuden UMK107CG330JZ
EXT PWR	1	Test point, red
F100	1	500mA fast-acting fuse (2405)
GND, REF	2	Test points, black
J1, J2, J4	3	3-pin headers
J3	1	2-pin header
J100	1	2 x 3-pin header
LED1–LED7, LED100–LED103	11	Green LEDs (1206)
P100	1	USB_B right-angle connector
P101, P102	0	Not installed
P1	1	5-pin header
P2	1	2 x 5-pin header
P3	1	11-pin header
P4	1	9-pin header
P5	1	4-pin header

Evaluates: MAX16031

MAX16031 Evaluation Kit

Component List (continued)

DESIGNATION	QTY	DESCRIPTION
Q1, Q2	2	npn bipolar transistors Fairchild MMBT3904 Diodes Inc. MMBT3904-7-F
R1–R7, R100–R103	11	221 Ω \pm 1% resistors (0805)
R8–R14, R104	8	10k Ω \pm 1% resistors (0805)
R23, R112	0	Not installed, resistors
R105, R106	2	33.2 Ω \pm 1% resistors (0805)
R108, R109, R110	3	4.75k Ω \pm 1% resistors (0805)
S1, S2, S3	3	8-row DIP switches
U1	1	Maxim EEPROM-based system monitor MAX16031ETM+ (48-pin TQFN)
U2	1	Maxim octal 12-bit voltage-output DAC with serial interface MAX5306EUE+ (16-pin TSSOP)
U3	1	Maxim precision, low-dropout, micropower voltage reference MAX6025AEUR+ (3-pin SOT23)

DESIGNATION	QTY	DESCRIPTION
U100	1	Maxim dual, low-noise, low-dropout linear regulator MAX8882EUTAQ+ (6-pin SOT23)
U101	1	Maxim USB peripheral controller MAX3420EECJ+ (32-pin LQFP)
U102	1	Maxim microcontroller MAXQ2000-RAX+ (68-pin QFN-EP*)
Y100	1	12MHz crystal (HCM49) Citizen HCM49-12.000MABJ-UT
Y101	0	Not installed, 32kHz crystal
Y102	1	20MHz crystal (HCM49) Citizen HCM49-20.000MABJ-UT
—	5	Shunts
—	1	USB high-speed A-to-B cable, 5ft (1.5m)
—	1	PCB: MAX16031 Evaluation Kit+

*EP = Exposed paddle.

Component Suppliers

SUPPLIER	PHONE	WEBSITE
Diodes, Inc.	805-446-4800	www.diodes.com
Fairchild Semiconductor	888-522-5372	www.fairchildsemi.com
KEMET Corp.	864-963-6300	www.kemet.com
Taiyo Yuden	800-348-2496	www.t-yuden.com
TDK Corp.	847-390-4373	www.component.tdk.com

Note: Indicate that you are using the MAX16031 when contacting these component suppliers.

Quick Start

Required Equipment

Before beginning, the following equipment is needed:

- MAX16031 EV kit (includes USB cable)
- A user-supplied PC with a spare USB port

Note: In the following sections, software-related items are identified by bolding. Text in **bold** refers to items directly from the EV kit software.

Procedure

The MAX16031 EV kit is fully assembled and tested. Follow the steps below to verify board operation:

- 1) Make sure jumpers J1 and J2 are in the 0 position, J3 is closed, J100 is in the 3.3V position, and J4 is in the 1-2 position. Also ensure that all switches in switch banks S1, S2, and S3 are all in the ON position.
- 2) Connect the MAX16031 EV kit to a PC using the USB cable provided with the EV kit. LED100 will light indicating that the EV kit has power.
- 3) Install the EV kit software.
- 4) Launch MAX16031.exe.
- 5) Click the **I2C** radio button in the **Connect** dialog box, and make sure **Address** is 0x18. Press the **OK** button.
- 6) Click the number **0.00** next to **DAC Voltage** for IN1.
- 7) In the **Set Input Voltage** dialog box, enter **1.00** and press the **OK** button.
- 8) Note that the voltage in the chart-recorder view increases to 1V.

MAX16031 Evaluation Kit

Evaluates: MAX16031

Detailed Description of Software

Connecting to the MAX16031 EV Kit

Make sure the EV kit is connected to the PC by the USB cable. Launch the software and in the **Connect** dialog (Figure 1), select the **I2C** or **JTAG** radio button and click **OK**. If the software is being used without the EV kit connected, select the **Demo (No Hardware Required)** radio button.

The I2C slave address may be specified. The default is **0x18**, but other values (depending on the settings of jumpers J1 and J2) can be used.

Voltages Tab

The **Voltages** tab (Figure 2) provides a visual indication of the voltage present on every IN_ input. Each channel has a settings dialog (accessed by clicking the underlined **IN_** link), a DAC output voltage setting, settings for each overvoltage and undervoltage threshold, two fault flags, and a chart-recorder view.

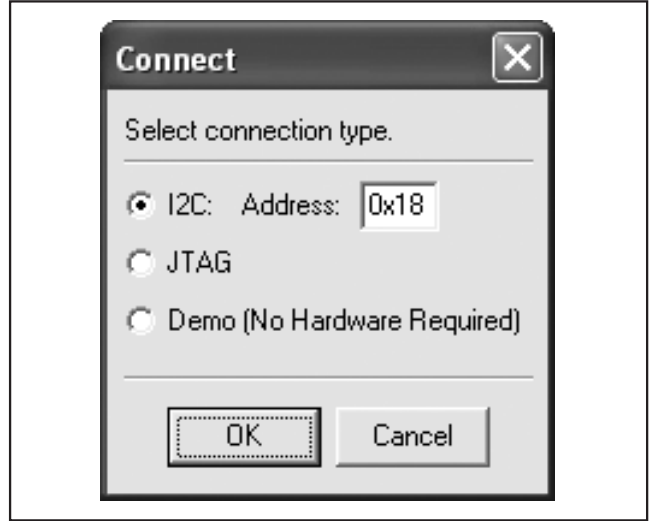

Figure 1. Connect Dialog

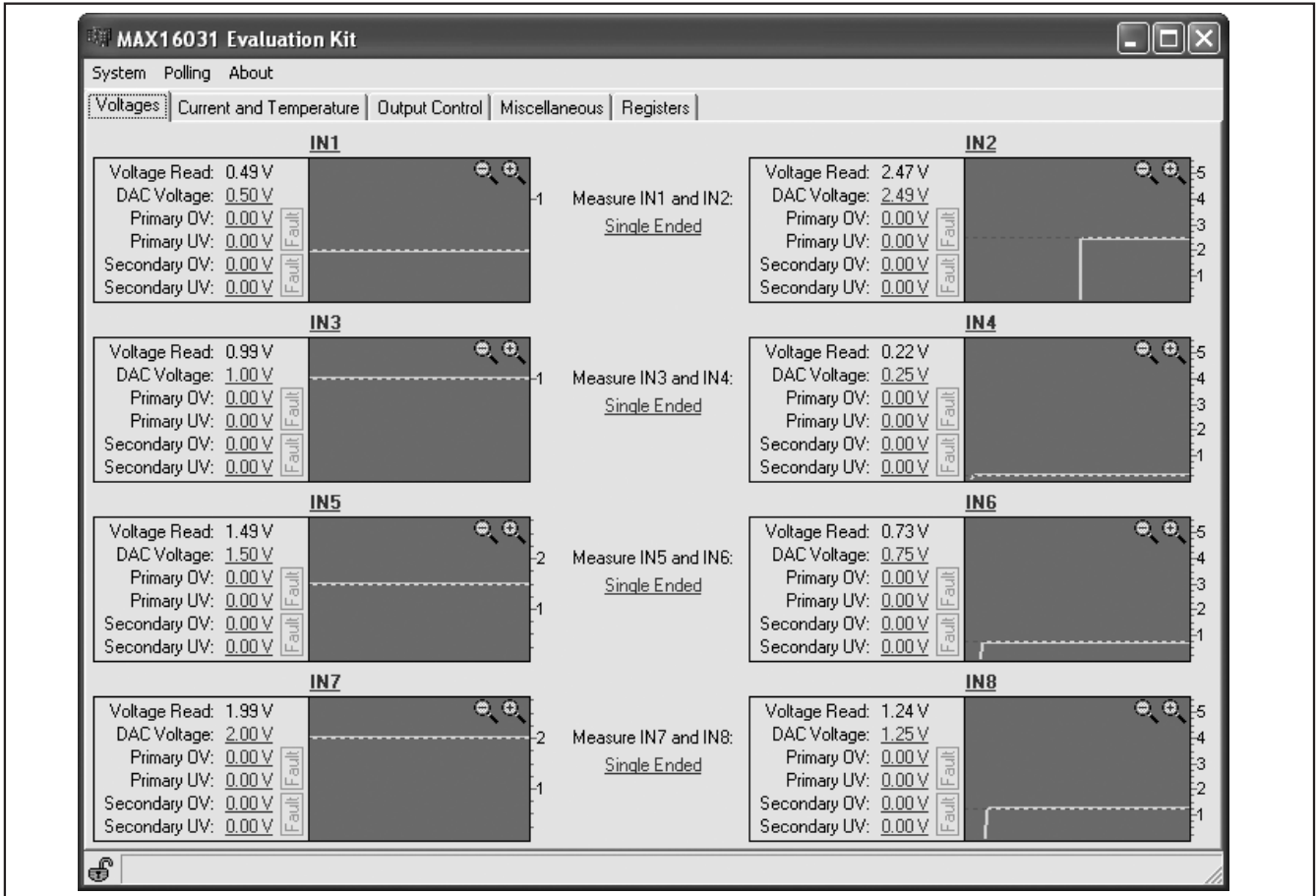

Figure 2. Voltages Tab

MAX16031 Evaluation Kit

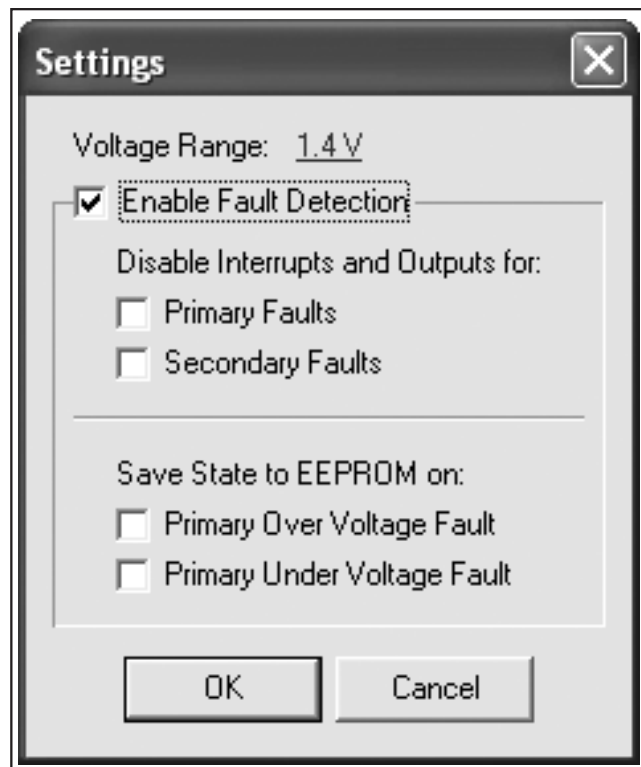

Figure 3. Settings Dialog

The **Settings** dialog (Figure 3) can set the IN input-voltage range to one of three settings: 1.4V, 2.8V, and 5.6V. To enable channel monitoring, make sure the **Enable Fault Detection** checkbox is selected. The **Disable Interrupts and Outputs for** group box allows faults on the primary or secondary thresholds to be “masked,” which prevents them from triggering an SMBus™ interrupt or asserting a fault output. **The Save State to EEPROM on** group box selects which type of fault can trigger a nonvolatile fault save operation.

Each IN_n input can be connected to the on-board MAX5306 DAC using switch bank S1. This allows the voltage at the IN_n input to be manually controlled through the EV kit software. Click the link next to **DAC Voltage** to set the voltage of the DAC in the 0 to 2.5V range. The DAC voltage can also be changed by dragging the dotted green line, shown in the chart-recorder view.

To set the primary or secondary overvoltage or under-voltage thresholds for a particular channel, click the appropriate underlined number next to that parameter. The primary thresholds can also be modified by dragging the dotted red lines in the chart-recorder view. The secondary thresholds can be changed the same way; both appear as dotted yellow lines.

Two fault flag indicators are associated with each channel. The upper one corresponds to the primary fault thresholds; the lower one corresponds with the secondary fault thresholds. If an undervoltage or overvoltage fault occurs, one or both these indicators will turn red and remain so even after the original fault condition is removed. To clear a fault indicator, click the indicator and select **Clear Fault** or **Clear All Faults** on the menu that appears.

Each chart-recorder view shows the voltage on the corresponding IN_n input with a solid green line. To zoom in and zoom out, click the magnifying glass icons in the upper right of the chart-recorder view. Another way to zoom in and out is to click and “drag” a selection rectangle. Drag from upper left to lower right to zoom in, and from lower right to upper left to zoom out.

Two IN inputs can be paired to form a combined differential input. Click any of the **Single Ended** links in the center of the window to pair two inputs together, or to separate two paired inputs.

MAX16031 Evaluation Kit

Current and Temperature Tab

The **Current and Temperature** tab (Figure 4) provides a set of chart-recorder views similar to the **Voltages** tab. To select the display units for the temperature sensors, click the appropriate setting of the **Temperature Display** radio buttons.

Similar to the input channels on the **Voltages** tab, the current and the temperature channels each have a settings dialog. Click the title of each channel to display

the settings dialog. To enable channel monitoring, make sure **Enable Fault Detection** is selected (Figure 5). The **Disable Interrupts and Outputs for** group box allows faults on the primary or secondary thresholds to be “masked,” which prevents them from triggering an SMBus interrupt or asserting a fault output. The **Save State to EEPROM on** group box controls whether a fault can trigger a nonvolatile fault save operation.

Evaluates: MAX16031

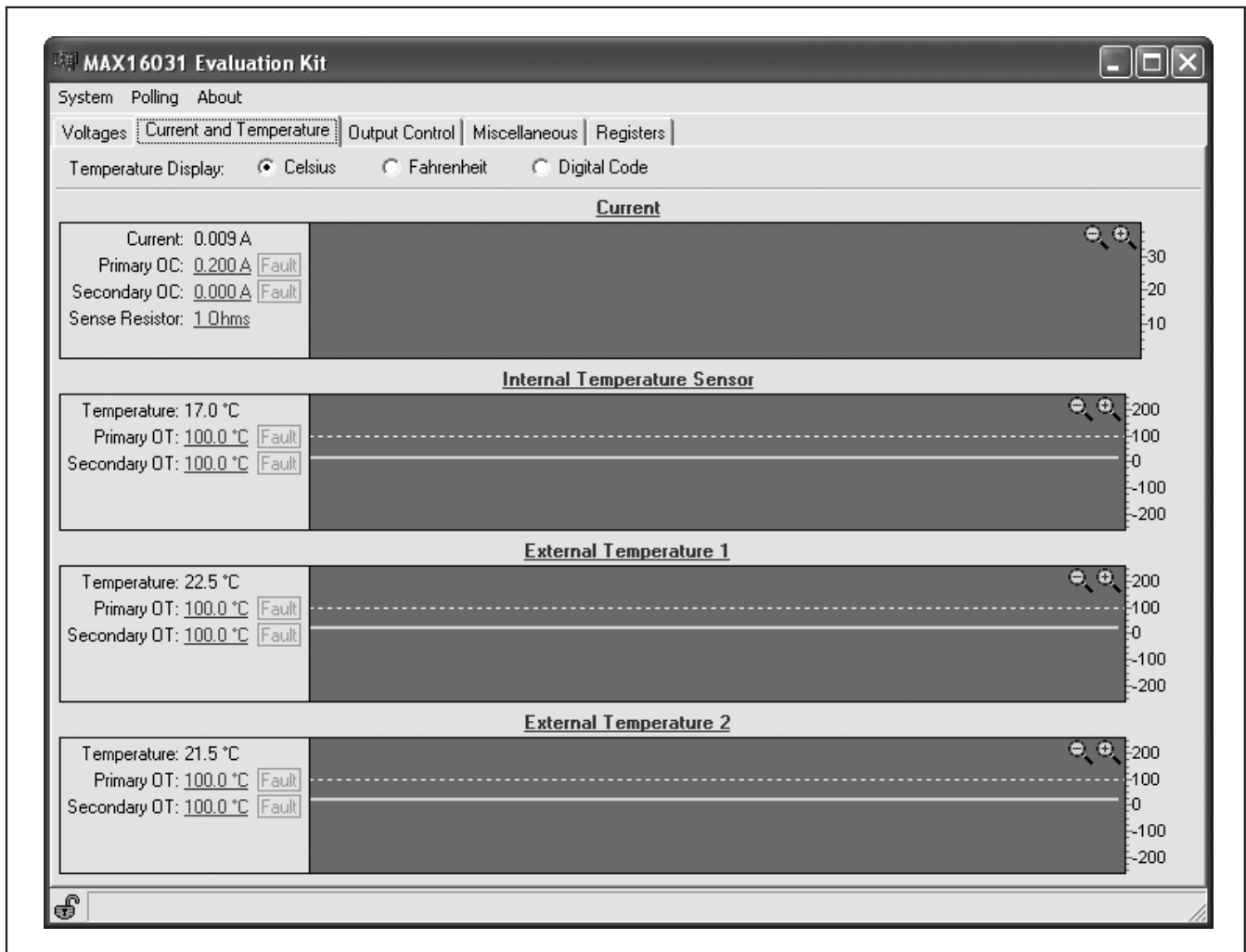

Figure 4. Current and Temperature Tab

MAX16031 Evaluation Kit

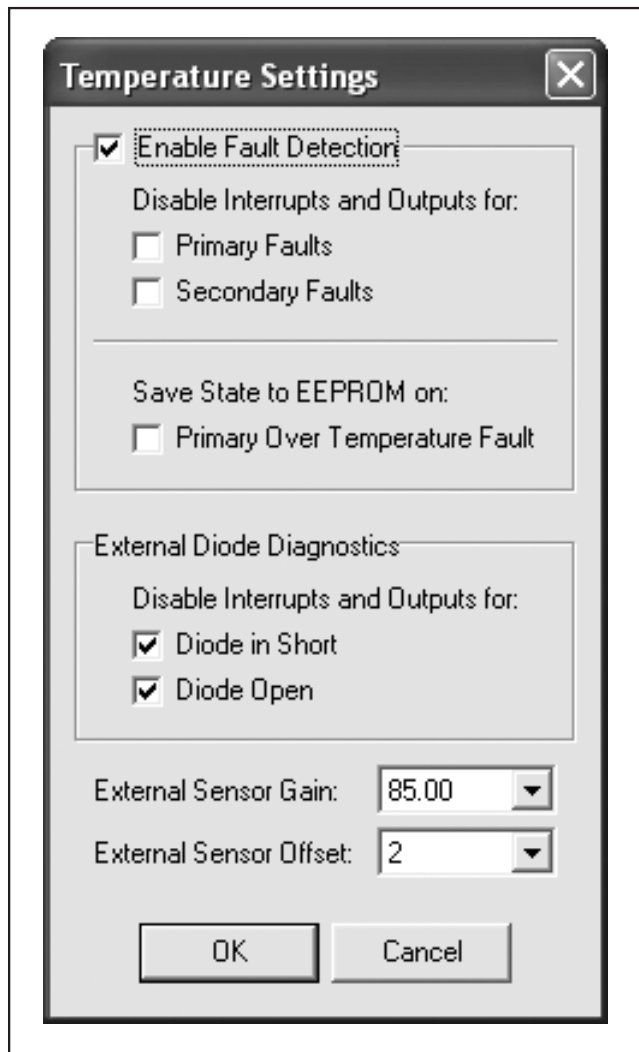

Figure 5. Temperature Settings Dialog

Each external temperature channel has some additional items on the settings dialog, shown in Figure 5. Additional fault mask bits are provided for the diode-short and diode-open faults, and two controls are provided to set the temperature offset and gain calibration parameters. The value provided for gain controls the current (in μA) of the internal high-current source, while the offset controls the digital offset value added to the temperature conversion result (in Celsius).

Output Control Tab

The **Output Control** tab (Figure 6) facilitates configuration of the programmable outputs.

The MAX16031 has several programmable outputs: FAULT1, FAULT2, OVERT, RESET, GPIO1, and GPIO2. The FAULT1 and FAULT2 outputs can be configured to depend on many combinations of fault conditions for all voltage, current, and temperature channels that are not masked. The OVERT output depends on combinations of temperature-related faults. Finally, the RESET output depends on a combination of fault conditions for both voltage and temperature and for a programmable set of voltage inputs. The RESET output also has a programmable timeout, which is the amount of time RESET remains asserted after all fault conditions are cleared.

GPIO1 and GPIO2 can be used as general-purpose inputs or outputs (GPIOs), and can also be configured to act as manual reset inputs or additional fault outputs.

When a GPIO is configured as a fault output, the following fault conditions can be monitored:

- Primary undervoltage and overvoltage for one selectable voltage channel
- One or more of the following: primary overvoltage for all voltage inputs, secondary over/undervoltage for all inputs, overtemperature for each sensor, or secondary overcurrent
- Both of the above options at once

MAX16031 Evaluation Kit

Evaluates: MAX16031

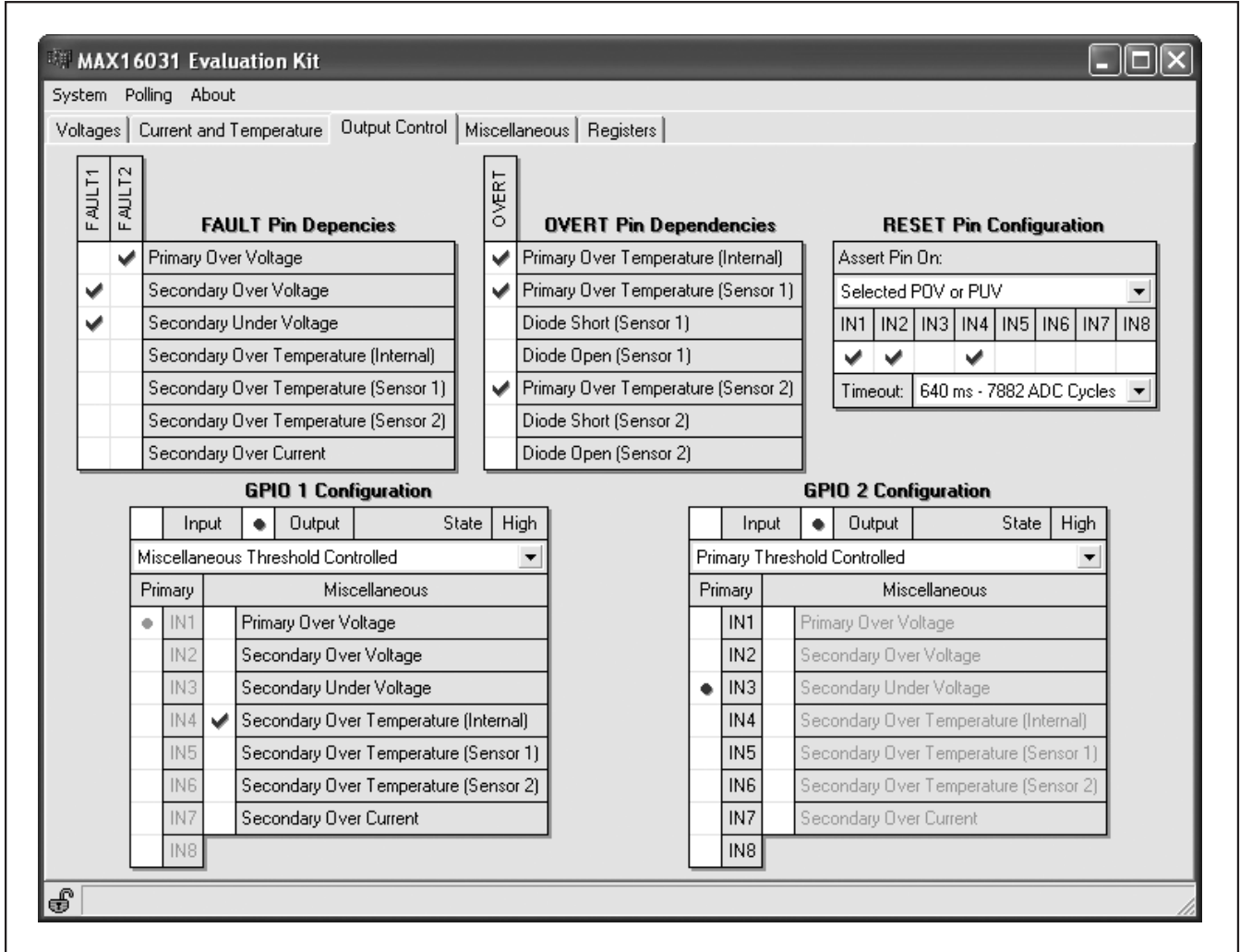

Figure 6. Output Control Tab

Miscellaneous Tab

Many other configuration options are available in the **Miscellaneous** tab (Figure 7): the boot-up delay, the temperature filter, overcurrent settings, deglitch settings, fault settings, memory lock bits, and the SMBus alert configuration.

The **After-boot timeout** setting controls the time delay from when power is applied, to when monitoring is enabled. This can prevent a partially powered system from triggering false fault signals during startup.

The **Temp sense filter time constant** provides the ability to filter the temperature sensors to reduce noise.

Overcurrent settings include **OC timeout**, which controls the amount of time a secondary overcurrent condition must be present before it triggers a fault, and **OC output pin**, which controls whether the OVERC output latches an overcurrent fault or follows the state of the primary overcurrent comparator.

Filtering of the voltage-monitoring channels is controlled by the **Hysteresis of all thresholds** setting, which sets the voltage difference between the rising and falling voltage threshold of each fault comparator. **Require 2 faults in a row**, when turned on, prevents any voltage fault from occurring unless the fault condition is present for two complete ADC conversion cycles in a row.

MAX16031 Evaluation Kit

The **On major fault** setting controls what information is saved to the fault EEPROM during a fault condition. **Save only fault flags** means that only the fault flags are stored to EEPROM during a fault event; **Save fault flags and ADC** means that both the fault flags and the ADC readings for all channels are stored to EEPROM during a fault event.

Version code provides user access to register 5Eh. This register does not control any function of the chip, but can be used to store user-defined data such as a version number.

The registers and the configuration EEPROM can be locked with the **Configuration** setting to prevent unintentional modification of configuration settings. The lock icon in the lower-left corner of the window also indicates and controls this lock bit.

The fault EEPROM is locked automatically when a fault condition occurs and must be unlocked before any subsequent fault will get stored to EEPROM. Unlock it using the **ADC-related EEPROM lock** setting.

To enable full SMBus functionality and allow the SMBALERT output to assert, the **SMBALERT# Signal** option must be enabled.

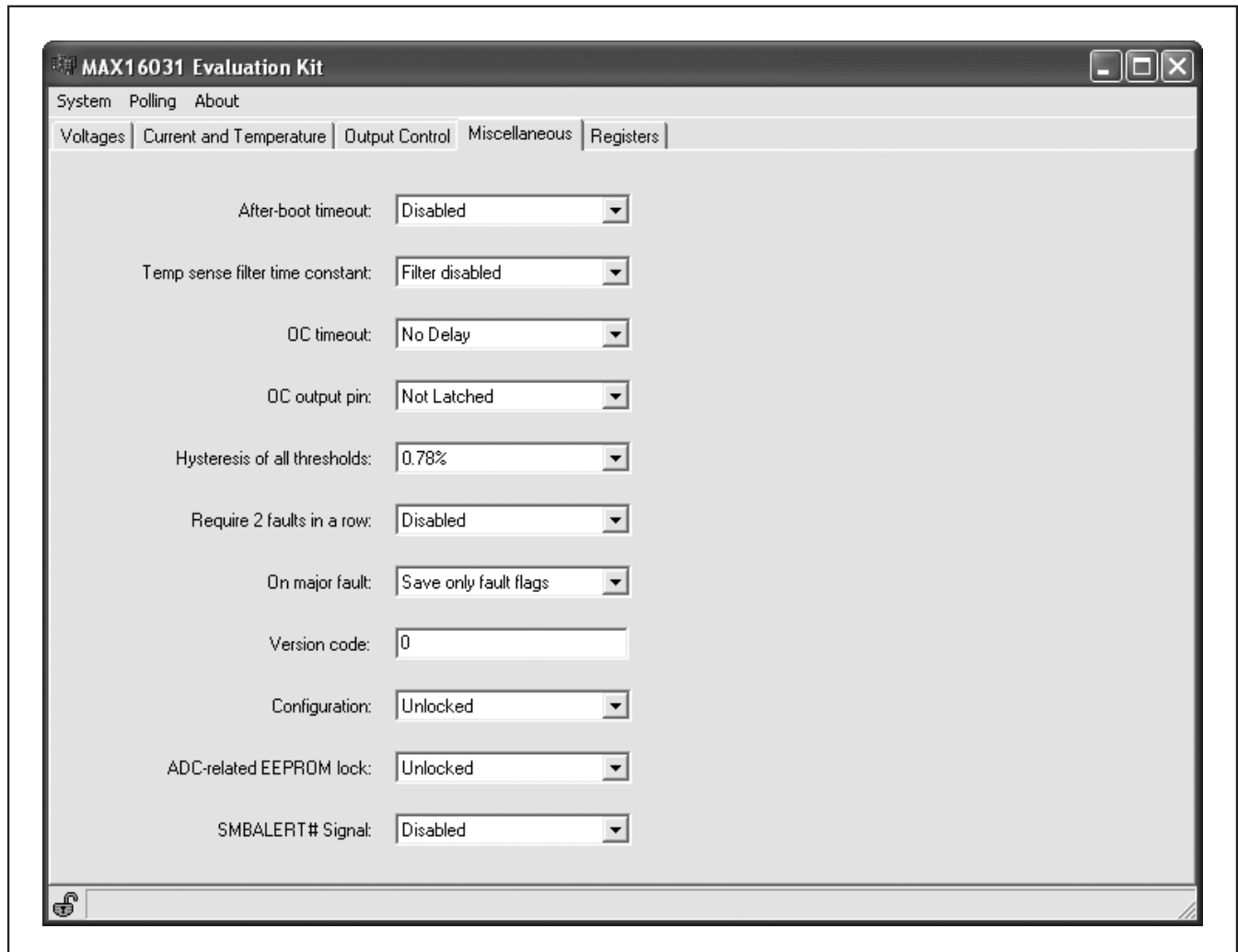

Figure 7. Miscellaneous Tab

MAX16031 Evaluation Kit

Evaluates: MAX16031

Registers Tab

Besides the easy-to-use GUI controls, the MAX16031 can also be configured by directly modifying the registers and EEPROM. The **Registers** tab (Figure 8) provides access to the registers and EEPROM. Modify a register by clicking the cell under the **Value** column, entering the new value, and pressing **Enter** or clicking in another cell.

Most configuration registers have a matching EEPROM location that is copied to the register when the MAX16031 powers up. The **Registers** tab places each pair on the same row. After experimenting with a particular register configuration, that configuration can be written to the EEPROM by clicking the **Commit Configuration to EEPROM** button.

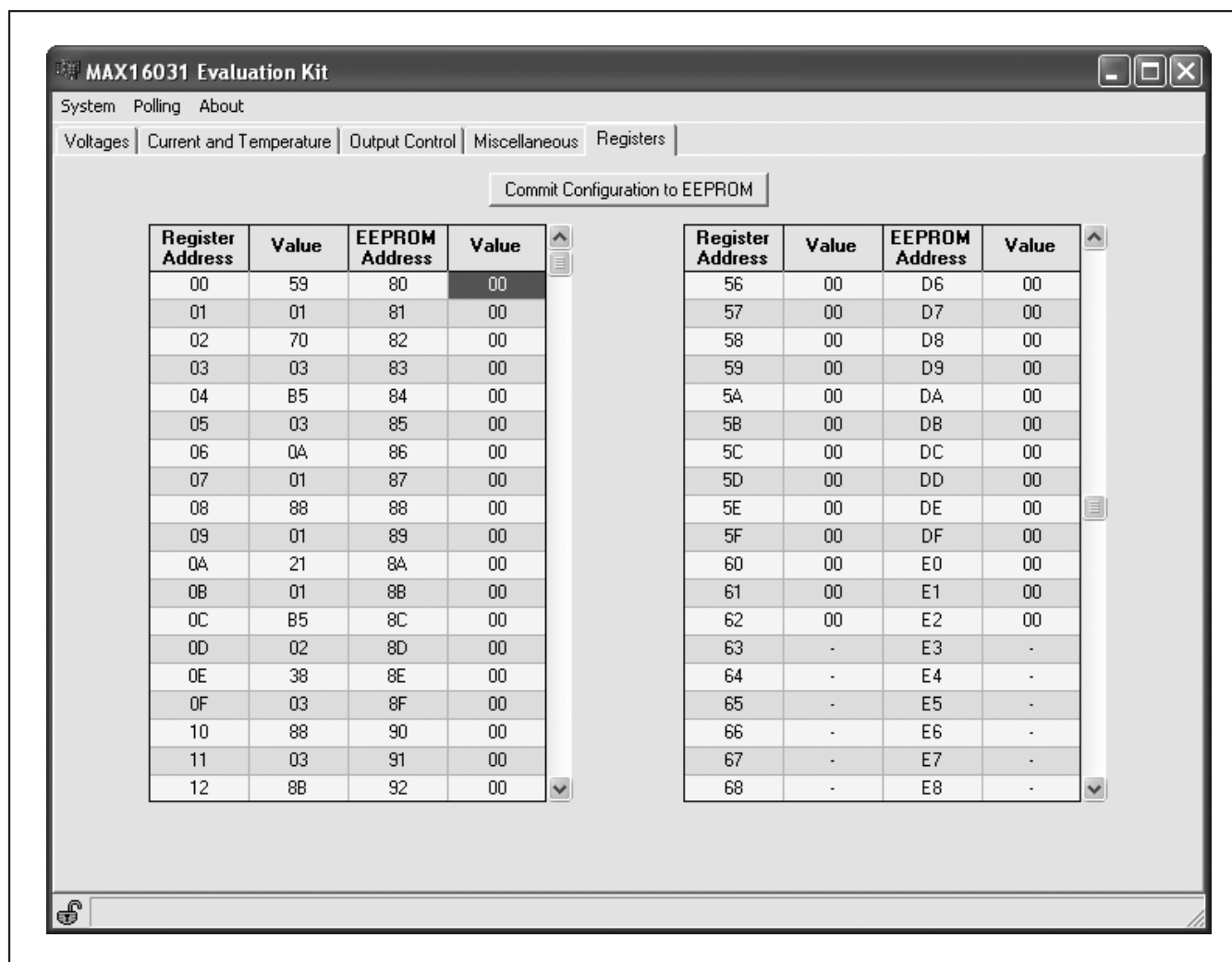

Figure 8. Registers Tab

MAX16031 Evaluation Kit

Menu Reference

System

Connect... directs the software to open a connection with a connected EV kit and brings up the **Connect** dialog (Figure 1) to select the connection type. Once connected, this menu item changes to **Disconnect**.

Save as SVF... writes the EEPROM configuration to an SVF file, which is a standard format used by JTAG device programmers for production programming.

Save Configuration... and **Load Configuration...** save and load the register and EEPROM configuration to a text file.

Polling

On and **Off** turn register polling on and off. When polling is on, the controls in all the tabs are periodically refreshed from the physical registers. If polling is off, register content can be read from the device by selecting **Read All Registers**.

About

This menu item launches the **About** dialog, which displays the software version, whether the EV kit is connected, and the firmware revision of the USB interface.

SMBus Alert Functionality

When the SMBALERT# signal is enabled using the option in the **Miscellaneous** tab, any fault that occurs will cause this signal to be asserted. When that happens, the status bar displays **SMBALERT# detected**. **Click here to send Alert Response Address**. Clicking the status bar item then causes the EV kit hardware to issue an **Alert Response Address** command, which returns the slave address of the SMBus device that triggered the SMBus alert.

Detailed Description of Hardware

The MAX16031 monitors eight voltages, three temperatures, and one current. Seven configurable outputs indicate fault-status information. Figure 9 provides an overview of the major features of the EV kit PCB.

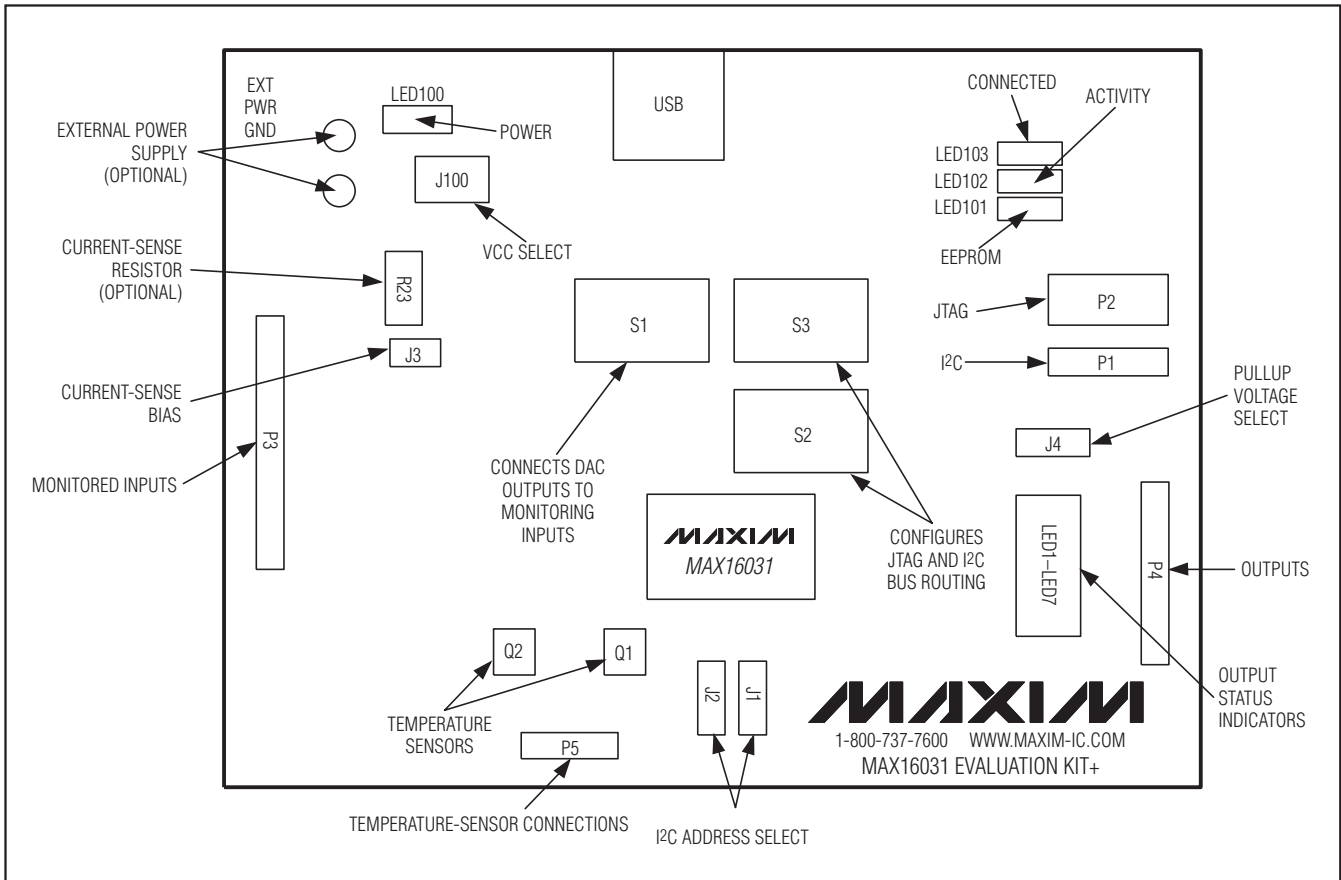

Figure 9. Evaluation Kit PCB Diagram

MAX16031 Evaluation Kit

Evaluates: MAX16031

USB-Host Interface

The MAX16031 EV kit includes a built-in USB-to-JTAG/I²C host interface. The host interface uses Maxim's MAX3420 USB peripheral controller, along with a MAXQ2000 microcontroller to communicate with the host PC and generate the I²C/JTAG bus signals. Three indicators (LED101, LED102, LED103) provide status information of the host interface. LED101 lights during EEPROM write operations, LED102 lights during I²C or JTAG bus activity, and LED103 lights when the software is communicating to the EV kit.

To facilitate prototype development and programming, the host interface can be used to interface with a MAX16031 on another board by turning off switches 1-7 in switch bank S2. This disconnects the on-board MAX16031 from the JTAG and I²C buses. Connect to the other board using P1 and P2. The pinout of each connector is shown in Tables 2 and 3. Note that the I²C pullup resistors are located on the EV kit.

The on-board MAX16031 can be connected to an external JTAG or I²C interface by turning switch bank S3 (switches 1-7) off while keeping switch bank S2 (switches 1-7) on. Connect the external interface to P2 for JTAG or P1 for I²C. The MAX16031 can be completely disconnected from the on-board USB host interface by using this technique, while providing external power to EXT PWR (J100 must be in the EXT position), and disconnecting the on-board DACs by turning off all the switches in switch bank S1.

Each interface can be disconnected or connected separately. I²C uses switches 1-3 on both S2 and S3 while JTAG uses switches 4-7 on both S2 and S3.

Power Source

The MAX16031 IC can be powered from one of three possible power supplies, controlled by jumper J100. To power directly from the USB 5V supply, place the jumper in the 5V position. To power from the on-board 3.3V regulator, place the jumper in the 3.3V position. When the jumper is in the EXT position, the MAX16031 can be powered from an external power supply connected to the EXT PWR test point. Do not supply a voltage higher than 14V.

Serial Interfaces

The MAX16031 has both a JTAG interface and an I²C serial interface. The slave address of the on-board MAX16031 can be set using J1 and J2, according to Table 4.

Voltage Monitoring

The eight voltage monitoring inputs connect to pins on P3 located on the left side of the board. Switch bank S1 allows each input to be connected to the output of a DAC, which allows the voltage to be set using the EV kit software for ease of evaluation. The DAC output voltage range is limited to 2.5V. Do not attempt to force an external voltage while the DAC is connected; doing so could damage the DAC or the external voltage source.

Current Monitoring

The current-sense inputs are connected to pins on header P3 and can be used in two ways. A small voltage source can be applied directly across CS+ and CS-, which the MAX16031 will measure directly. For this situation, J3 must be closed, which connects CS+ to VCC to ensure proper bias. As an alternative, a current-sense resistor can be soldered in the R23 position and CS+ and CS- can be connected in series with the external circuit to be measured.

If an external bias voltage is to be used, remove J3 and connect the CS+ pin of P3 to the external source. Do not supply a bias voltage higher than 28V. The current-sense circuit in the MAX16031 will not function for bias voltages less than 3V.

Temperature Monitoring

One of the temperature sensors is internal and the other two are external. Both external temperature sensors are included on the EV kit as Q1 and Q2, which are diode-connected 2N3904 transistors. These can be desoldered and replaced if necessary. The connections are easily accessible through header P5.

Inputs and Outputs

Each output has a separate indicator LED and pullup resistor, and each signal is brought out to a pin on P4. An LED will light to indicate that the associated output has gone to the logic-low state. The LEDs can be disabled by turning off switch 8 in switch bank S2. The pullup resistors are controlled by J4. To use an external pullup voltage, connect J4 in the 2-3 position and connect the voltage source to the VPU pin of P4.

GPIO1 and GPIO2 can also function as inputs. If they are configured as such, connect the external input to the GPIO1 or GPIO2 pin of P4.

A test point (REF) is provided to confirm the reference voltage of the MAX16031, which is 1.4V (nominal). Do not connect loads to this test point.

MAX16031 Evaluation Kit

Evaluates: MAX16031

Jumper Function Tables

Table 1. Jumper Function Table (J100, J3, J4, S1, S2, S3)

JUMPER	POSITION	FUNCTION
J100	5V*	MAX16031 powered from 5V USB power
	3.3V	MAX16031 powered from 3.3V regulator
	EXT	MAX16031 powered from EXT PWR test point
J3	Open	Current-sense amplifier biased externally (CS+ test point)
	Closed*	Current-sense amplifier biased from MAX16031 V _{CC}
J4	1-2*	Output pullup resistors connected to 3.3V
	2-3	Output pullup resistors connected to VPU test point
S1	1	Connects IN1 to DAC channel 1 when closed
	2	Connects IN2 to DAC channel 2 when closed
	3	Connects IN3 to DAC channel 3 when closed
	4	Connects IN4 to DAC channel 4 when closed
	5	Connects IN5 to DAC channel 5 when closed
	6	Connects IN6 to DAC channel 6 when closed
	7	Connects IN7 to DAC channel 7 when closed
	8	Connects IN8 to DAC channel 8 when closed
S2	1	Connects P1 (I ² C) to on-board MAX16031 when closed
	2	
	3	
	4	Connects P2 (JTAG) to on-board MAX16031 when closed
	5	
	6	
	7	
	8	Enables output LEDs when closed
S3	1	Connects I ² C bus of host interface to P1 when closed
	2	
	3	
	4	Connects JTAG bus of host interface to P2 when closed
	5	
	6	
	7	
	8	Not used

*Default position.

MAX16031 Evaluation Kit

Evaluates: MAX16031

Table 2. I²C Connector Pinout (P1)

PIN	FUNCTION
1	3.3V (output only)
2	SDA
3	Ground
4	SCL
5	SMBALERT#

Table 3. JTAG Connector Pinout (P2)

PIN	FUNCTION
1	TCK
2	Ground
3	TDO
4	3.3V (output only)
5	TMS
6	—
7	— (Key)
8	—
9	TDI
10	Ground

Table 4. Jumper Function Table (J1, J2)

J1 SHUNT POSITION (A1)	J2 SHUNT POSITION (A0)	I ² C SLAVE ADDRESS
0*	0*	0011_000 (18h)
0	Z	0011_001 (19h)
0	1	0011_010 (1Ah)
Z	0	0101_001 (29h)
Z	Z	0101_010 (2Ah)
Z	1	0101_011 (2Bh)
1	0	1001_100 (4Ch)
1	Z	1001_111 (4Fh)
1	1	1001_110 (4Eh)

*Default position.

MAX16031 Evaluation Kit

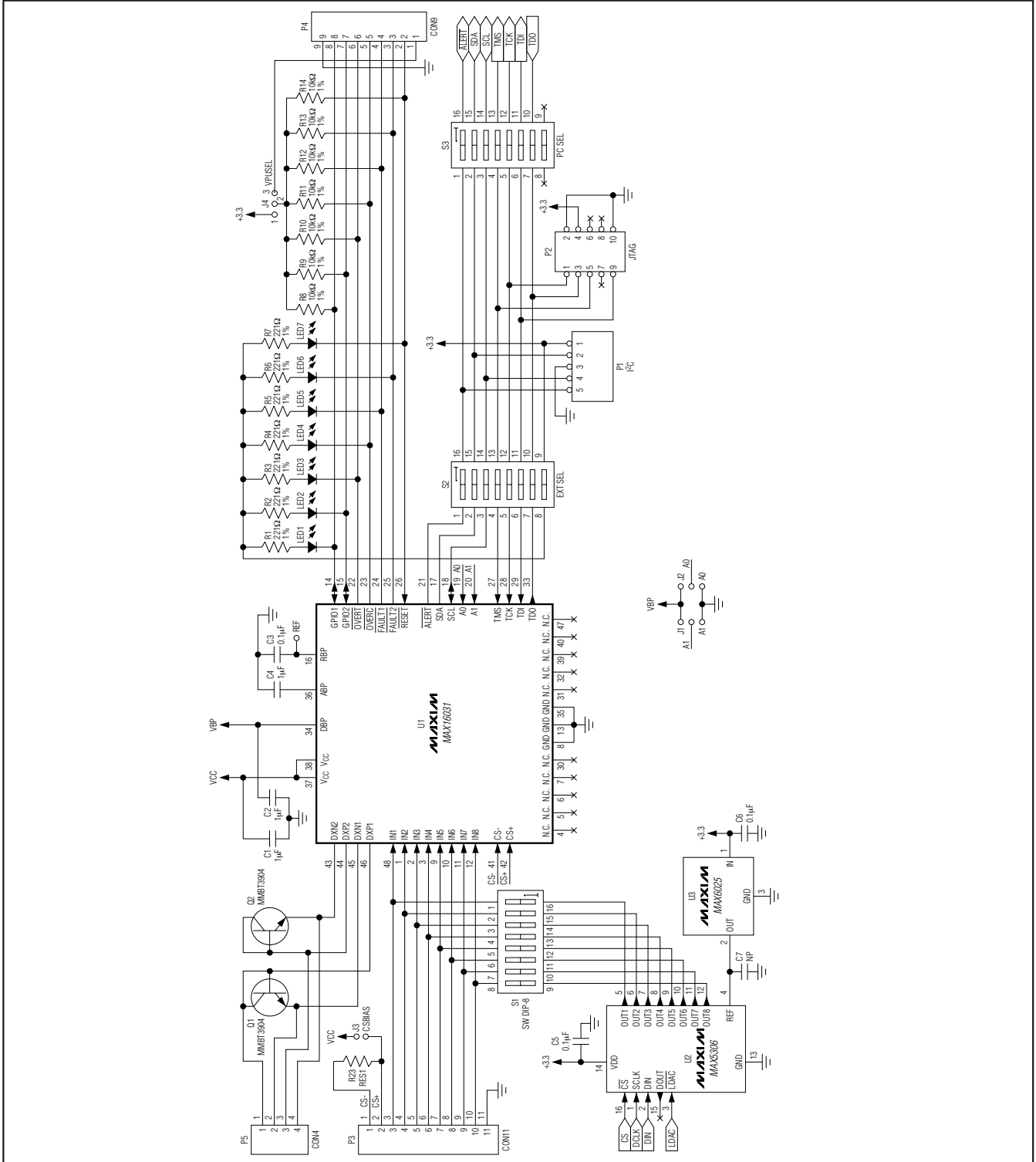

Figure 10. MAX16031 EV Kit Schematic

MAX16031 Evaluation Kit

Evaluates: MAX16031

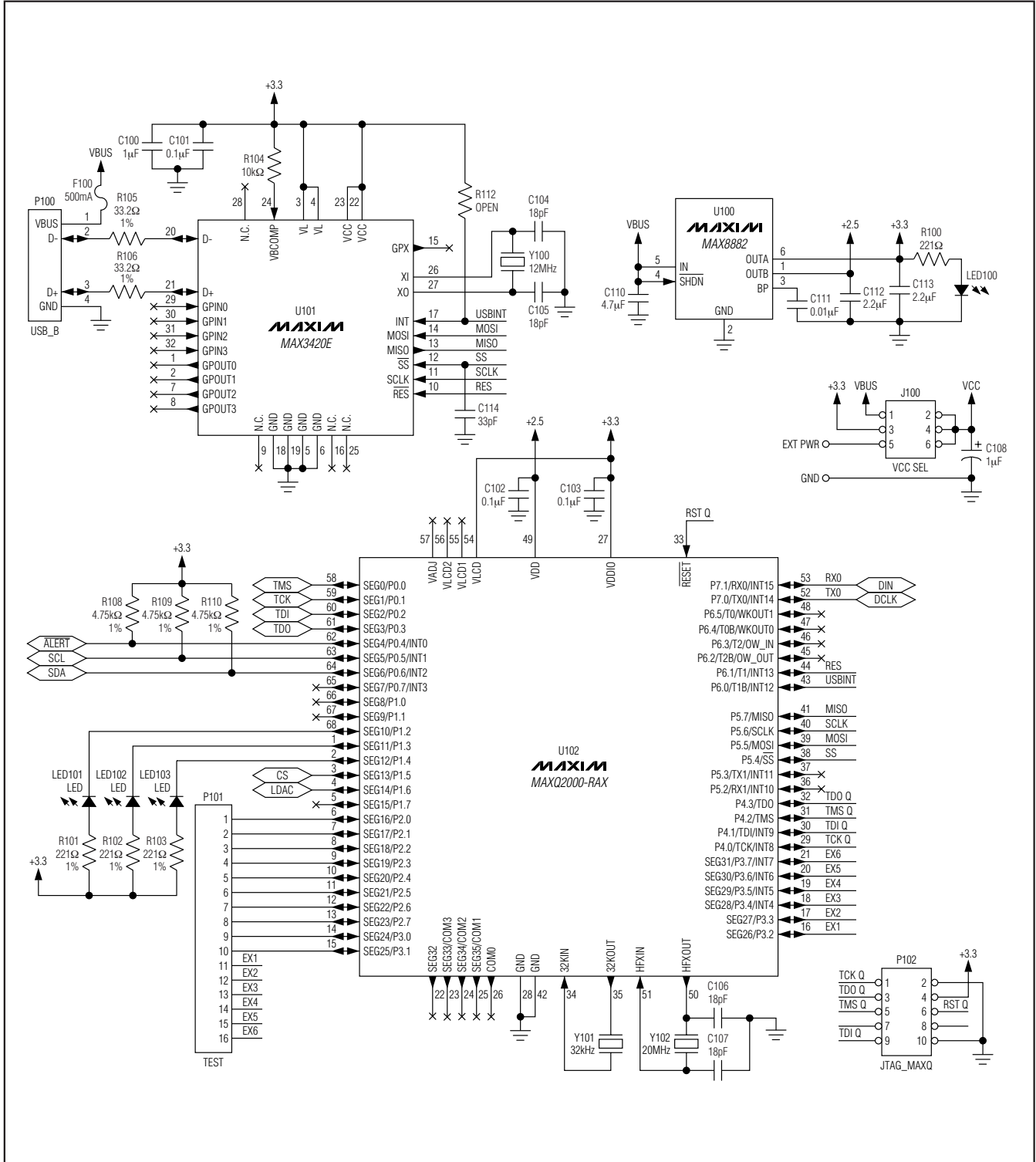

Figure 11. MAX16031 EV Kit Schematic—USB Interface

MAX16031 Evaluation Kit

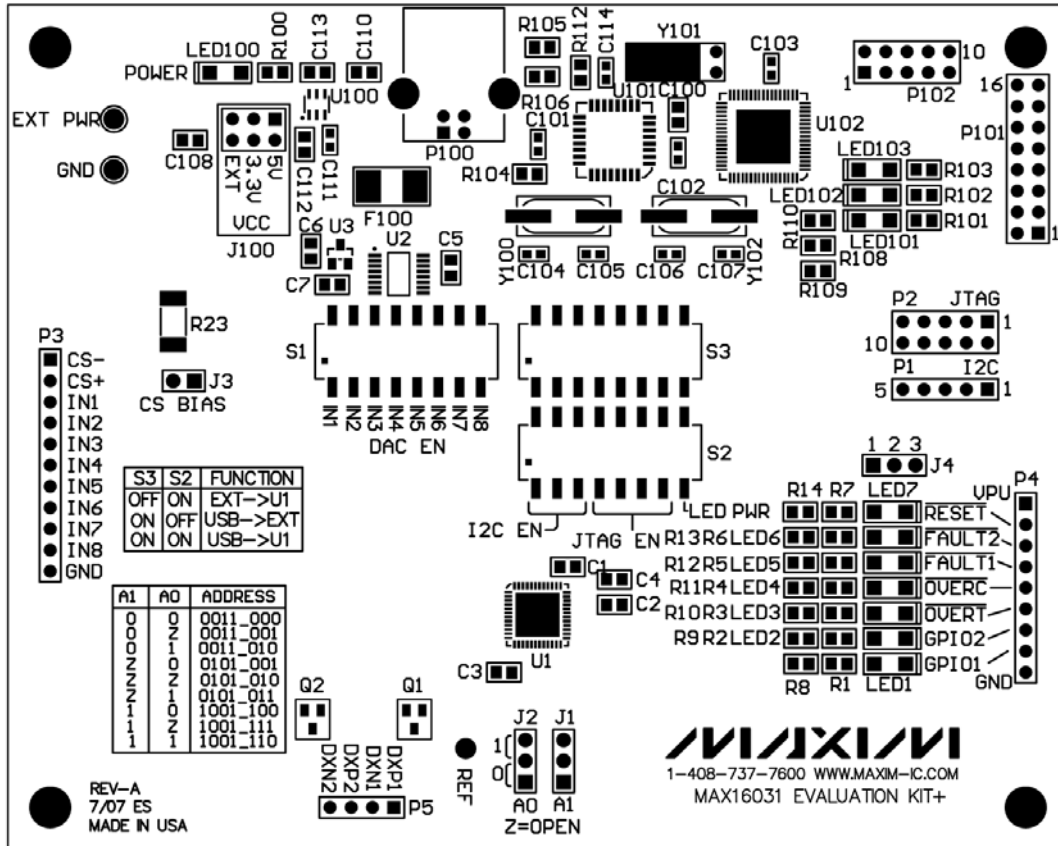

Figure 12. MAX16031 EV Kit Component Placement Guide—Component Side

MAX16031 Evaluation Kit

Evaluates: MAX16031

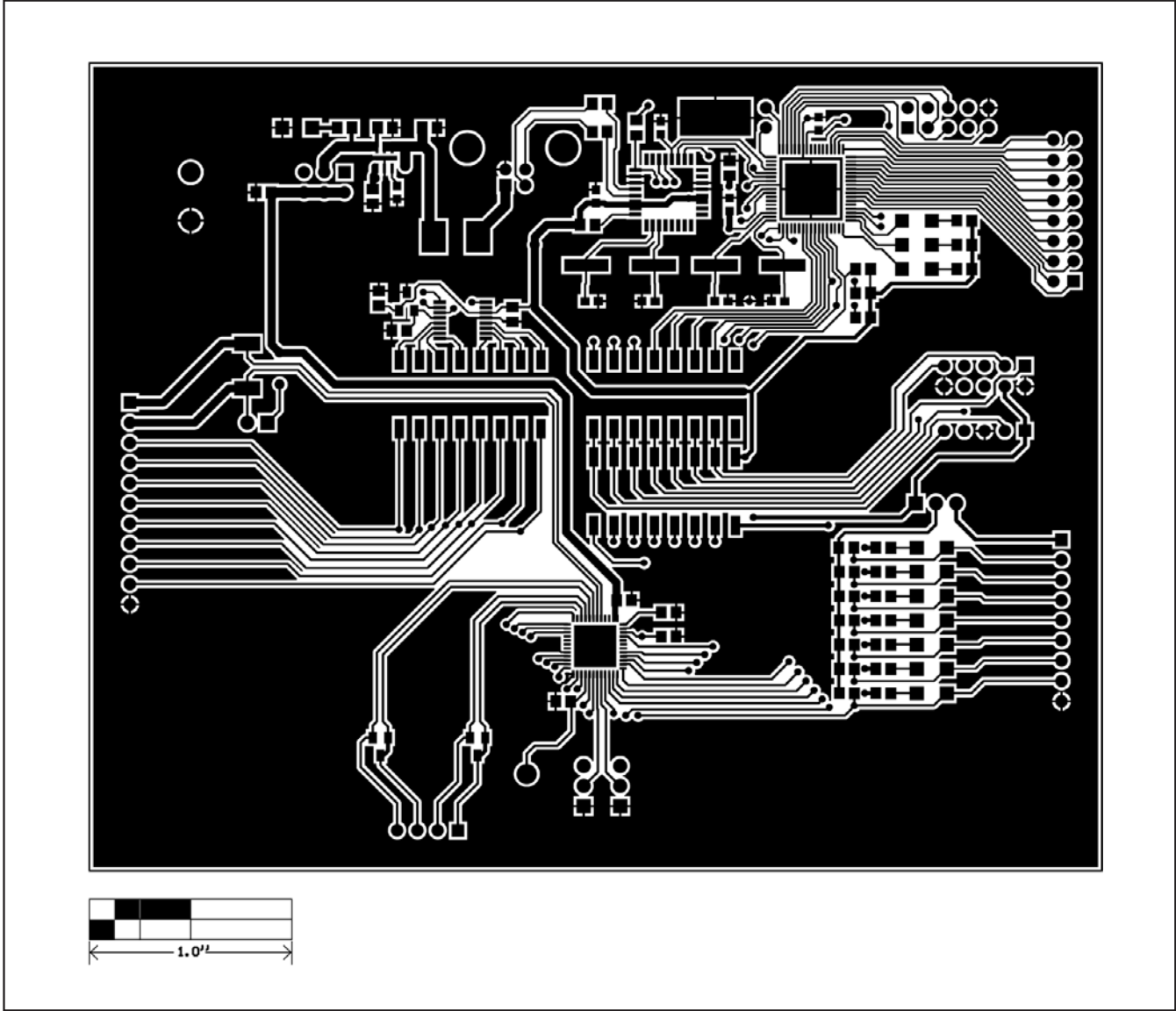

Figure 13. MAX16031 EV Kit PCB Layout—Component Side

MAX16031 Evaluation Kit

Evaluates: MAX16031

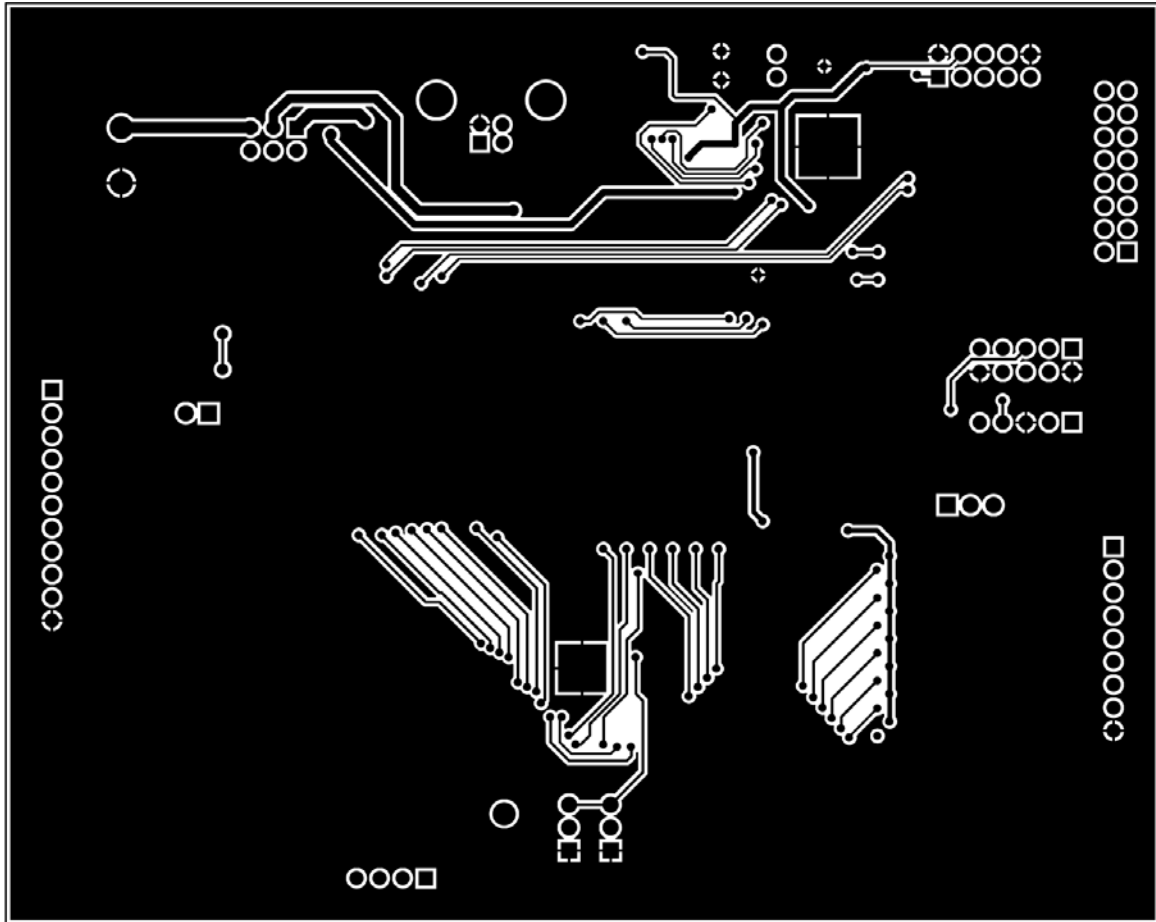

Figure 14. MAX16031 EV Kit PCB Layout—Solder Side

Maxim cannot assume responsibility for use of any circuitry other than circuitry entirely embodied in a Maxim product. No circuit patent licenses are implied. Maxim reserves the right to change the circuitry and specifications without notice at any time.

18 Maxim Integrated Products, 120 San Gabriel Drive, Sunnyvale, CA 94086 408-737-7600

© 2007 Maxim Integrated Products

MAXIM is a registered trademark of Maxim Integrated Products, Inc.